

Fieldbus System (128 Points/64 Points)

EX500 Series

Decentralized valve installation

Valves can be installed near the actuators!

- Reduced piping space and piping materials
- Reduced wiring space
- No need to set the address for the valve manifolds and input units



* Only the SY and SV valves are UL-compliant.

GW unit (Gateway unit)

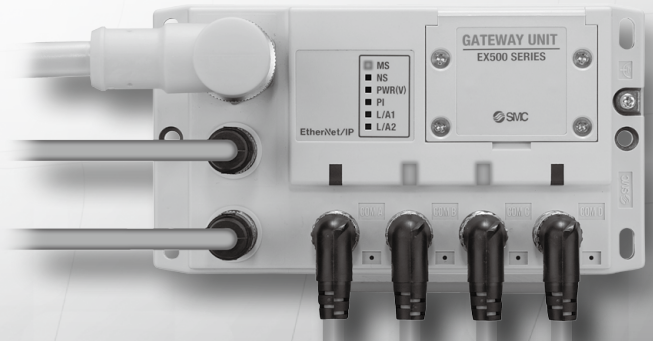

Description	Compatible protocol	Number of inputs/outputs	Number of valve manifold and input unit connections	Branch cable length	New function
Gateway Decentralized System 2 Page 61	 EtherNet/IP	128 inputs/128 outputs	Max. 16 units	Max. 20 m	Web server function <ul style="list-style-type: none"> Valve operation test Connection diagnostic Short-circuit diagnostic Page 56
Gateway Decentralized System Page 75	 DeviceNet	64 inputs/64 outputs	Max. 8 units	Max. 10 m	—

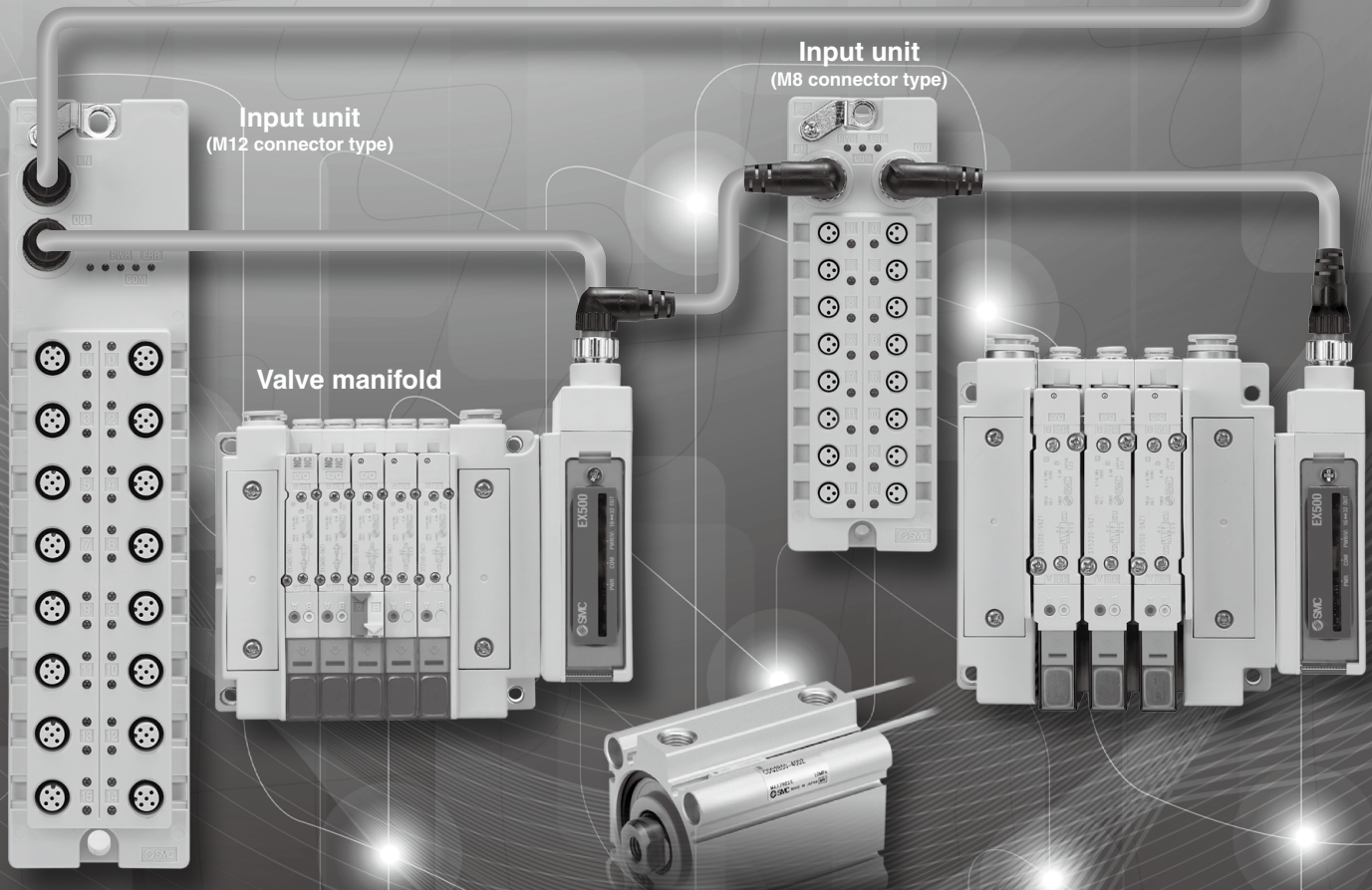

Type 1	EX260
Type 1	EX123/124/126
Type 2	EX500
Type 2	EX600
Type 3	EX245
Type 3	EX250
Type 1	EX120/121/122
Type 1	EX140
Type 2	EX180
Type 2	EX510
Type 2	M8/M12
Type 2	ATEX

Gateway Decentralized System 2 (128 Points)

● Number of branch ports: 4

Number of inputs/outputs **128** inputs/**128** outputs

● Number of inputs/outputs per branch: Max. 32 inputs/32 outputs

Number of valve manifold connections **Max. 8 units*1** Number of input unit connections **Max. 8 units**

● Number of valve manifold connections per branch: Max. 2 units*1 ● Number of input unit connections per branch: Max. 2 units

Total cable length per branch **Max. 20 m**

*1 When the number of outputs is set to "16 outputs" using the built-in setting switch of the SI unit

Maximum number of inputs: **128** points Maximum number of outputs: **128** points

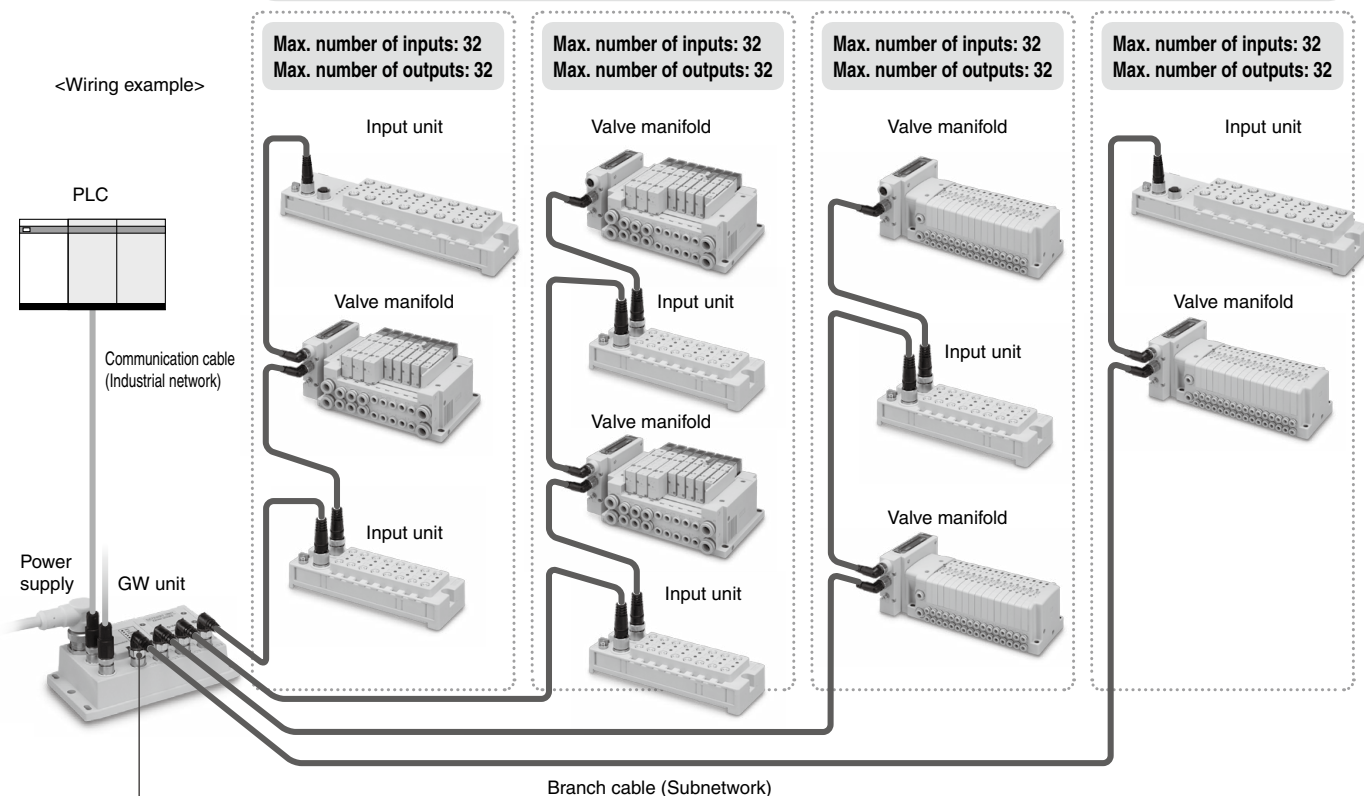

Branch port

Two valve manifolds can be connected to one branch port.

The SI unit has a built-in setting switch which switches the number of outputs (32 points/16 points) of the valve manifold connected to the SI unit. By setting the number of outputs to 16 points, two valve manifolds can be installed to one branch port.

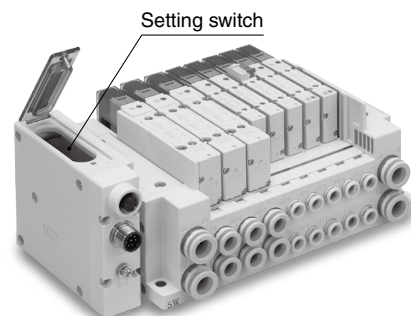

SI unit



Web server function

A valve operation test (ON/OFF), a connection diagnostic between the valve manifolds and the input units, and a short-circuit diagnostic of input devices can be performed on a web browser.

A password can be used for the valve operation test (ON/OFF) for security.

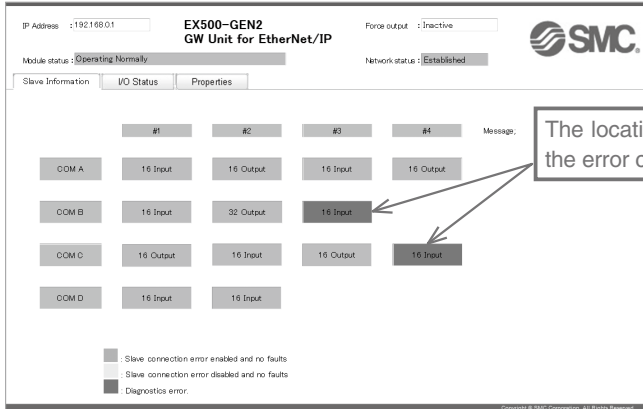

* Web display example

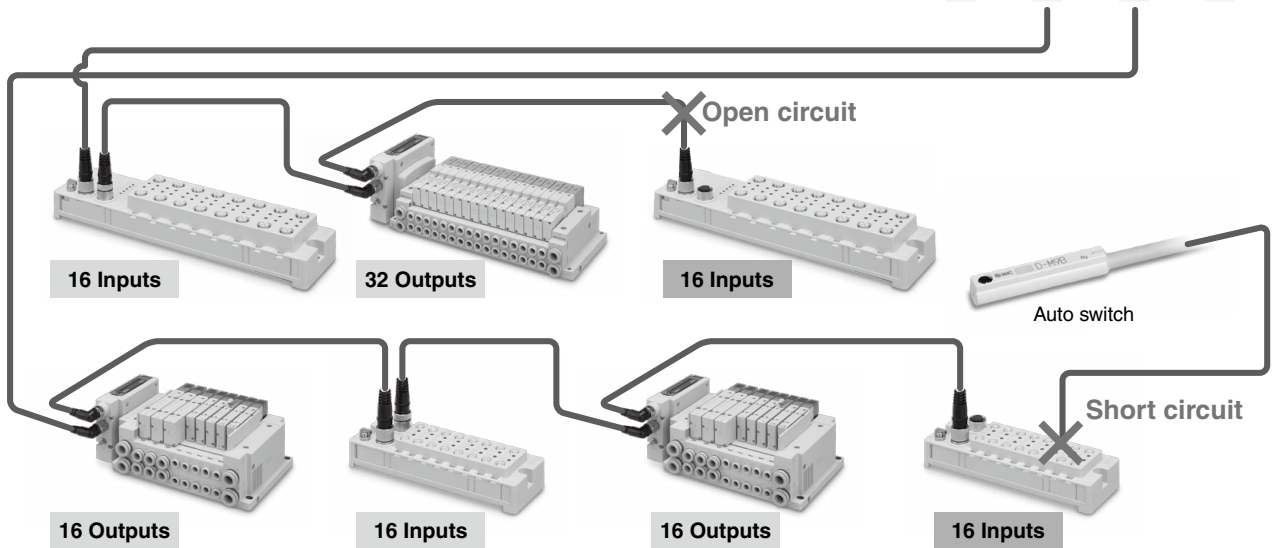
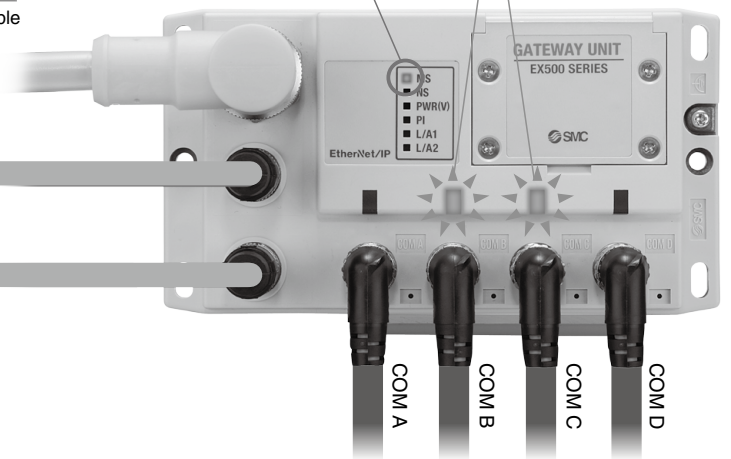

No need to set the address

I/O mapping for the SI unit and input unit is set by the gateway unit automatically.

The unit installation order is not specified.

(The upper limit of the inputs/outputs is 32 points for one branch port.)

Type 1	EX260
Type 1	EX123/124/126
Type 2	EX500
Type 3	EX600
Type 3	EX245
Type 3	EX250
Type 1	EX120/121/122
Type 1	EX140
Type 1	EX180
Type 2	EX510
	M8/M12
	ATEX

Gateway Decentralized System 2 (128 Points)

Reduced wiring

The amount of communication and power supply wiring for the I/O device can be reduced.

Reduction in number of communication nodes

By reducing the number of communication nodes, the load on the network is reduced.

Accessories can be ordered together.

Page 67 Page 84

Accessories including cables and connectors can be ordered together from SMC. Parts selection and ordering times as well as delivery management can be reduced.



Flexibly copes with changes in the protocol

Previously, it was necessary to change the part number of the slave unit, return the slave unit, and make arrangements once again to obtain a new unit (additional quotation, delivery management).



Now, only the GW unit needs to be changed.

Applicable to output devices other than valve manifolds

Page 71

By using an output block, lights and buzzers can be operated.

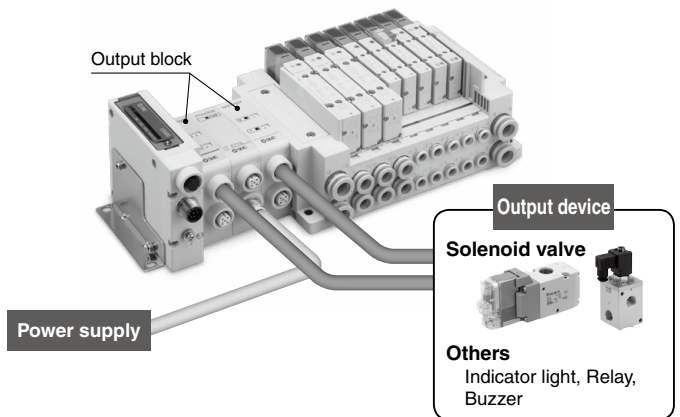



Specified valve manifolds can be controlled by supplying power from a different system.

Page 69

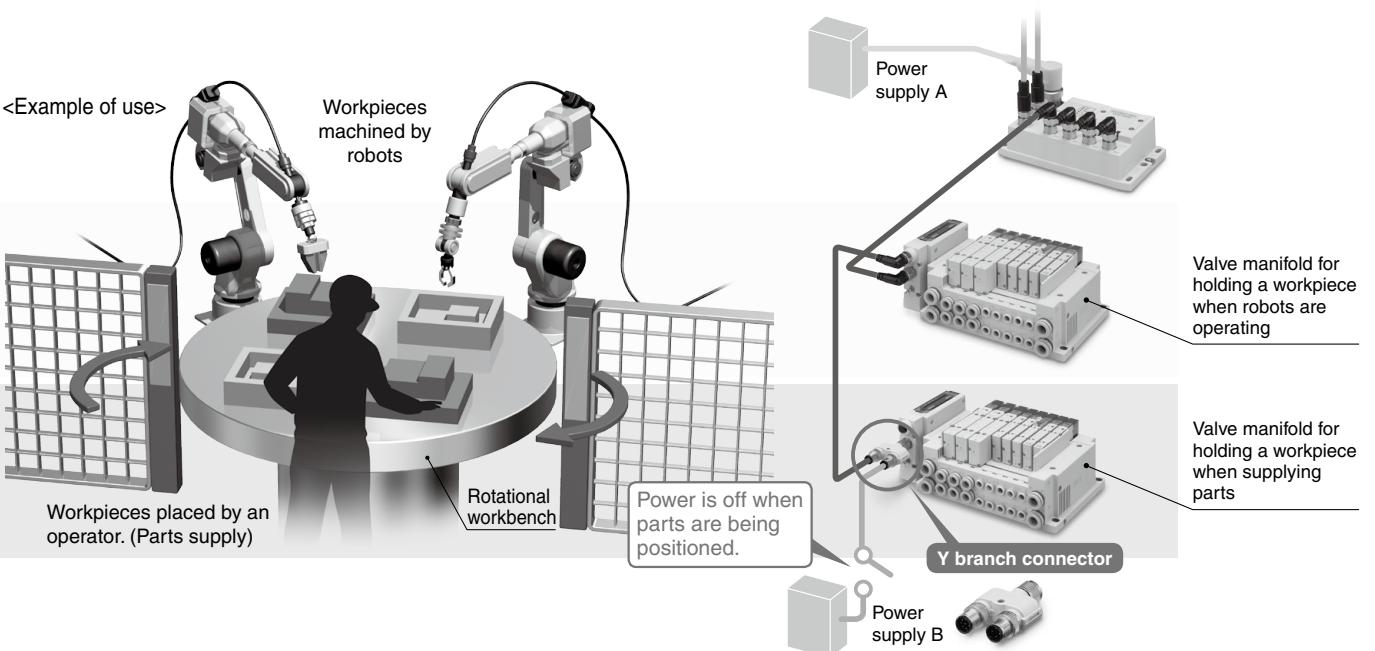
By using a Y branch connector, power from a different system can be supplied to the SI unit (valve manifold).





System Comparison Table

	Gateway Decentralized System 2	Gateway Decentralized System (Current model)
Protocol	 EtherNet/IP™	DeviceNet™ 
Number of inputs/outputs (Number of inputs/outputs per branch)	128 inputs/128 outputs (32 inputs/32 outputs)	64 inputs/64 outputs (16 inputs/16 outputs)
Number of valve manifold connections (Number of connections per branch)	Max. 8 units*¹ (Max. 2 units)	Max. 4 units (1 unit)
Number of input unit connections (Number of connections per branch)	Max. 8 units (Max. 2 units)	Max. 4 units (1 unit)
Branch cable length	Max. 20 m	Max. 10 m
Enclosure	GW unit: IP65 SI unit: IP67 Input unit: IP67	GW unit: IP65 SI unit: IP67 Input unit: IP65
Function	Web server function (Valve operation test, Connection diagnostic, Short-circuit diagnostic)	—
Page	61	75

*1 When the number of outputs is set to "16 outputs" using the built-in setting switch of the SI unit

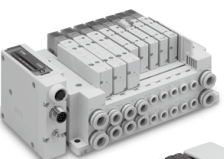
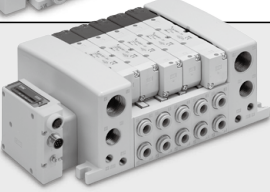
Applicable Valve Series

Series	Flow rate characteristics (4/2→5/3)		Maximum number of solenoids	Power consumption [W]	Enclosure	Standards	Page
	C [dm ³ /(s·bar)]	b					
	SY3000	1.6	0.19	32	0.35 (Standard) 0.1 (With power-saving circuit) [Inrush 0.4, Holding 0.1]	IP67	CE Best Pneumatics No. 1-1
	SY5000	3.6	0.17				
	SY7000	5.9	0.20				
	VQC1000	1.0*¹	0.30*¹	24	0.4 (Standard) 0.95 (Standard) 0.4 (Low-wattage type)	IP67	CE Best Pneumatics No. 1-2
	VQC2000	3.2*¹	0.30*¹				
	VQC4000	7.3*¹	0.38*¹				
	VQC5000	17.0*¹	0.31*¹				
	S0700	0.37	0.39	32	0.35	IP40	CE Best Pneumatics No. 1-1
	SV1000	1.1	0.35	32	0.6	IP67	CE Best Pneumatics No. 1-2
	SV2000	2.4	0.18				
	SV3000	4.3	0.21				

*1 Values for 2-position single, rubber seal type

Type 1
EX260
EX123/124/126
EX500
EX600
EX245
EX250
EX120/121/122
EX140
EX180
EX510
M8/M12
ATEX

SY3000/5000/7000 Series

Piping on the top or the bottom allows for a reduced footprint and increased space saving.

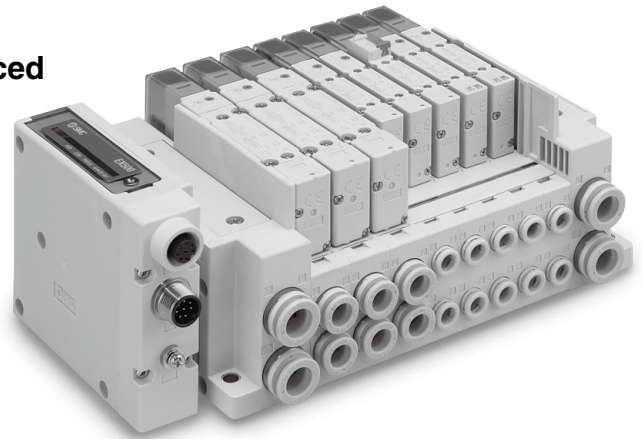

Valve piping direction variations

■ Piping is possible from 3 directions.

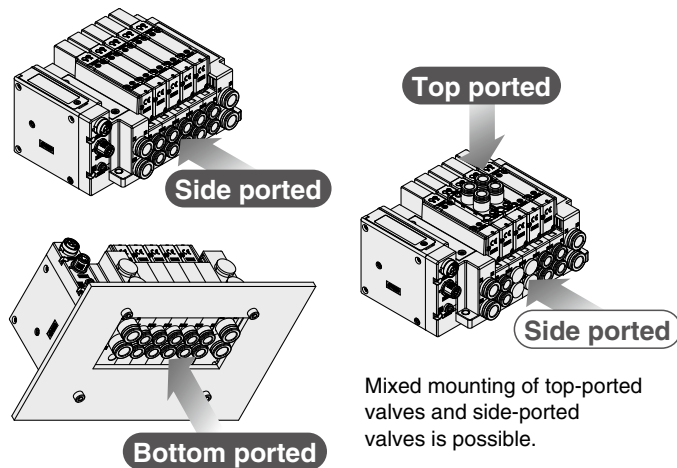

Max. 24 stations are connectable.

■ It is possible to connect only the number of valves required, from 1 to 24 stations, to suit the application. (Maximum number of solenoids: 32)

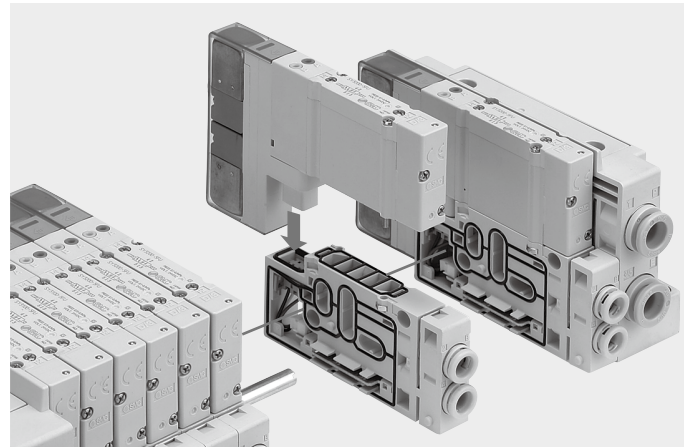

Mixed valve sizes manifold

It is also possible to install a combination of different-sized valves on the same manifold. (SY3000 and SY5000, or SY5000 and SY7000)

This facilitates a reduction in the installation space and number of units/cables.

■ Example: For the SY5000 and SY3000

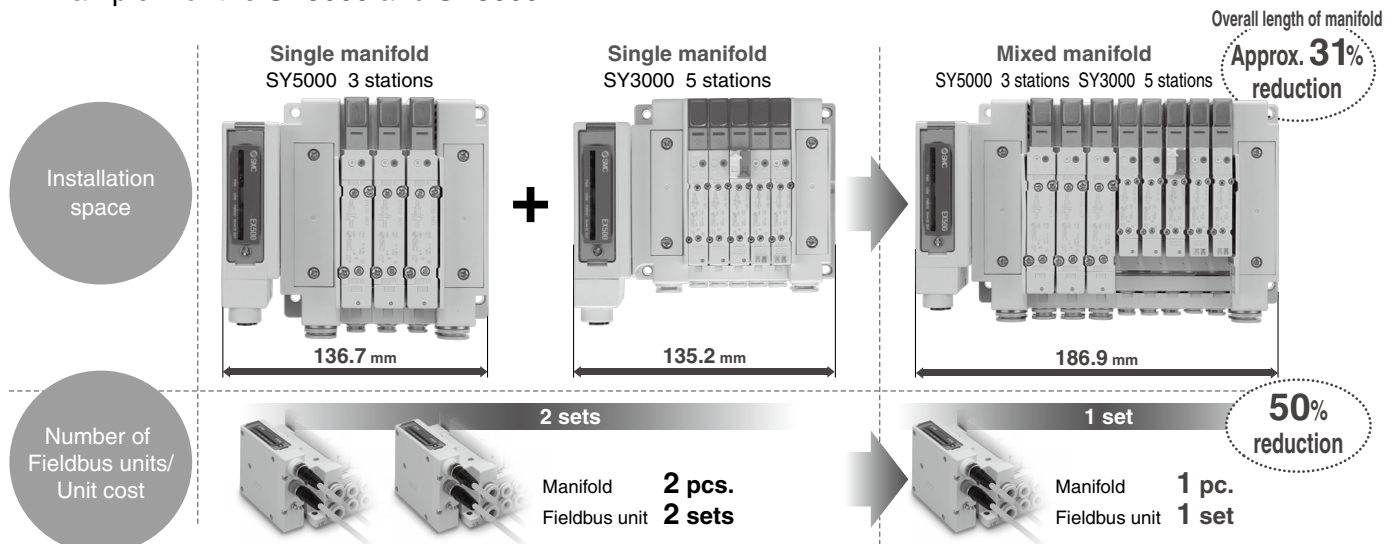

CONTENTS

Type 2 Gateway type

Fieldbus System (128 Points/64 Points)

EX500 Series

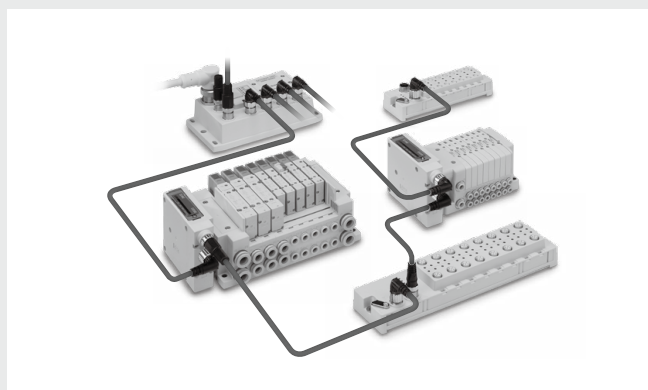

Gateway Decentralized System 2 (128 Points) p. 61

GW Unit

How to Order	p. 62
Specifications	p. 62
Dimensions/Parts Description	p. 63

SI Unit

How to Order	p. 64
Specifications	p. 64
Dimensions/Parts Description	p. 64

Input Unit

How to Order	p. 65
Specifications	p. 65
Dimensions/Parts Description	p. 65

LED Indicator p. 66

Accessories

① Power Supply Cable	p. 67
② Communication Cable	p. 68
③ Field-wireable Communication Connector	p. 68
④ Branch Cable	p. 69
⑤ Y Branch Connector	p. 69
⑥ Cable for Power Supply from a Different System ...	p. 70
⑦ DIN Rail Bracket (2 pcs.)	p. 70
⑧ Marker (1 sheet, 88 pcs.)	p. 70
⑨ Seal Cap (10 pcs.)	p. 70
⑩ Output Block	p. 71
⑪ Power Block	p. 71
⑫ Power Supply Cable (For power block)	p. 72
⑬ Connector for Output Block Wiring	p. 73
⑭ End Plate	p. 73
⑮ Bracket Plate/DIN Rail Mounting Bracket	p. 73

Made to Order

Communication Cable	p. 88
Power Supply Cable	p. 91

Precautions on Mixed Usage of Gateway Decentralized System 2 (128 Points) and Gateway Decentralized System (64 Points)	p. 74
--	-------

Specific Product Precautions	p. 92
------------------------------------	-------

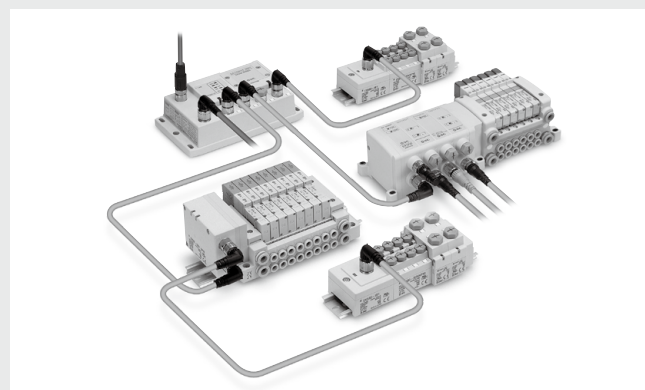

Gateway Decentralized System (64 Points) ... p. 75

GW Unit

How to Order	p. 76
Specifications	p. 76
Dimensions/Parts Description	p. 76

SI Unit (For SV)

How to Order	p. 77
Specifications	p. 77
Dimensions/Parts Description	p. 77

SI Unit (For SY/VQC/S0700)

How to Order	p. 78
Specifications	p. 78
Dimensions/Parts Description	p. 78

Input Manifold

How to Order	p. 79
How to Order Input Manifold	p. 79
Specifications	p. 80
Dimensions/Parts Description	p. 81
How to Add Input Block Stations	p. 82

LED Indicator p. 83

Accessories

① Communication Cable	p. 84
② Field-wireable Communication Connector	p. 85
③ Power Supply Cable	p. 86
④ Branch Cable	p. 87
⑤ Terminal Plug	p. 87
⑥ Seal Cap (1 pc.)	p. 87
⑦ Seal Cap (10 pcs.)	p. 87

Type 1
EX260
EX123/124/126

Type 2
EX500

EX600

Type 3
EX245

EX250

EX120/121/122

Type 1
EX140

EX180

Type 2
EX510

M8/M12

ATEX

Fieldbus System Gateway Decentralized System 2 (128 Points) **EX500 Series** (CE)



- ★ Valve manifolds and input units can be connected around the GW (Gateway) unit.
- ★ Compatible with other protocols by replacing the GW unit
- ★ Number of inputs/outputs = 128 points/128 points
The number of outputs (solenoids) per branch is 32 points.
- ★ Number of valve manifold connections = Max. 8 units, Number of input unit connections = Max. 8 units, Branch cable length = Max. 20 m
- ★ Web server function (Valve operation test, Connection diagnostic of units, Short-circuit diagnostic of input devices)
- ★ No need to set the address for the valve manifolds or input units

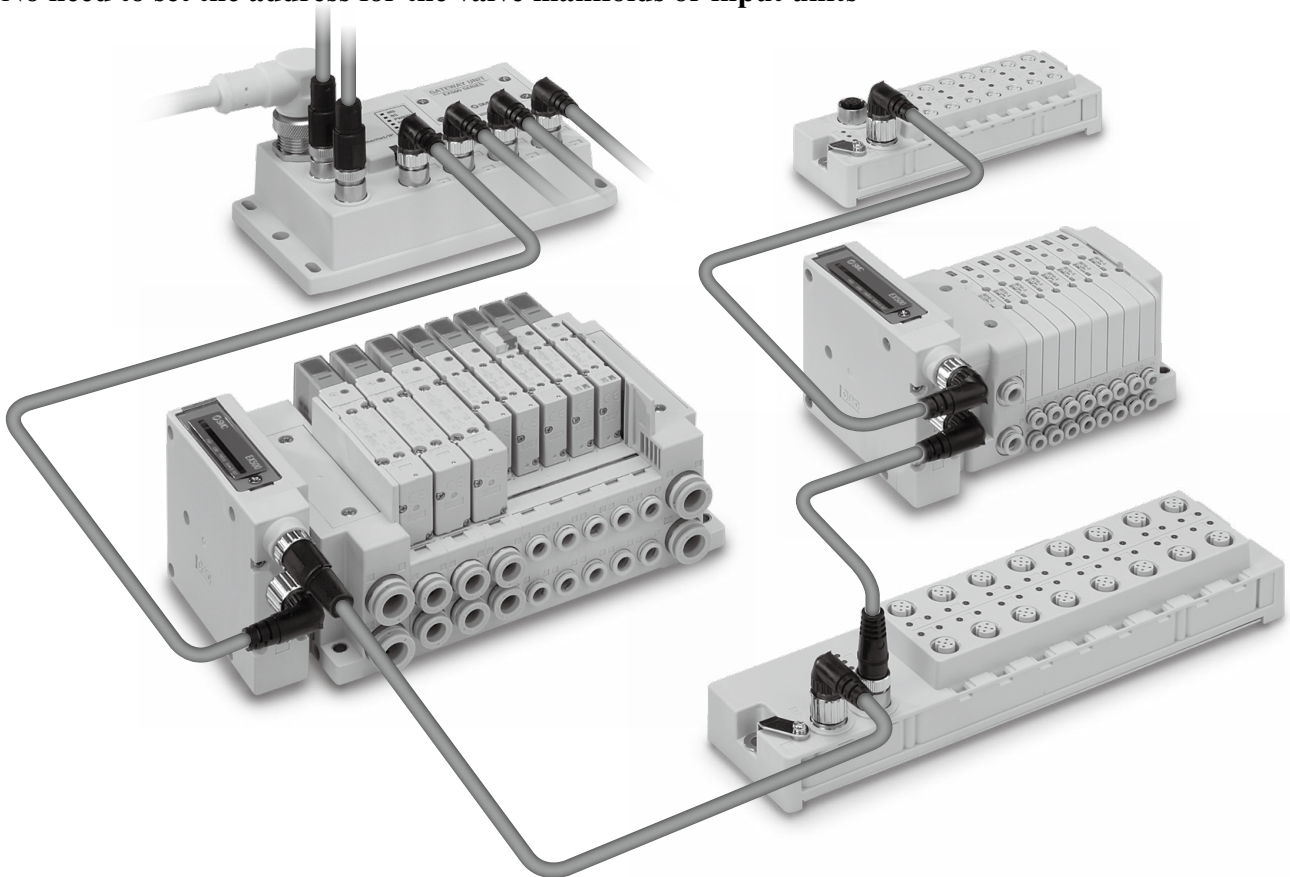

Manifold Solenoid Valves

SY3000/5000/7000

VQC1000/2000/4000/5000

S0700

SV1000/2000/3000

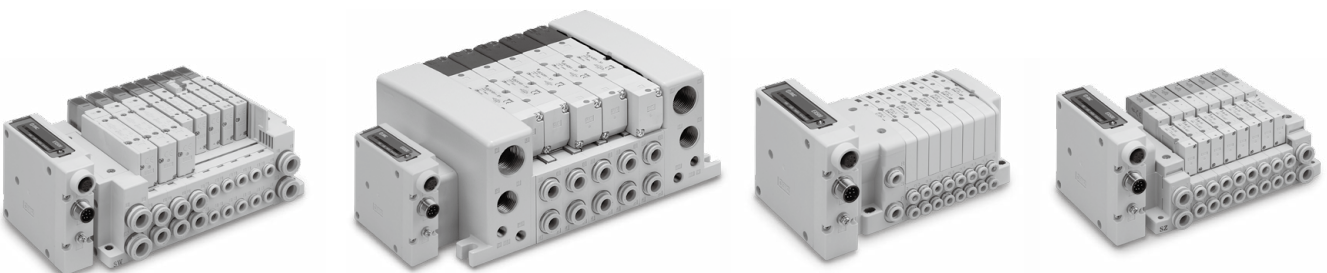

How to Order



EX500 – G EN2

Protocol

EN2	EtherNet/IP™ (Input/Output = 128 points/128 points)
PN2	PROFINET (Input/Output = 128 points/128 points)

Specifications

Model		EX500-GEN2	EX500-GPN2
Communication	Protocol	EtherNet/IP™*1	PROFINET IO
	Version*2	Volume 1 (Edition 3.14) Volume 2 (Edition 1.15)	PROFINET Specification Version 2.2
	Media	100BASE-TX	100BASE-TX
	Communication speed	10/100 Mbps (Automatic)	100 Mbps
	Communication method	Full duplex/Half duplex (Automatic)	Full duplex
	Number of inputs/ outputs (I/O occupation area)	128 inputs/128 outputs (20 bytes/20 bytes)	128 inputs/128 outputs (18 bytes/16 bytes)
	Configuration file*3	EDS file	GSDML
	IP address setting range	Switch settings: 192.168.0.1 to 254 or 192.168.1.1 to 254, Through DHCP server: Optional address	Optional address
	Device information	Vendor ID: 7 (SMC Corporation) Product type: 12 (Communication Adapter), Product code: 198	—
Applicable function		DLR QuickConnect™ Web server	MRP Fast Start Up Web server
Power supply voltage	For input and control	24 VDC ±10%	
	For valve	24 VDC +10%, -5%	
Current consumption	For input and control	6.2 A or less (Max. 1.5 A per branch x 4 branches + GW unit internal current consumption: 0.2 A or less)	
	For output (valve)	4 A or less (Max. 1 A per branch x 4 branches)	
Branch port	Number of branch ports	4 ports	
	Number of inputs and outputs	32 inputs/32 outputs per branch	
	Branch cable length	20 m or less per branch	
Environmental resistance	Enclosure	IP65	
	Operating temperature range	Operating: -10 to +50°C, Stored: -20 to +60°C (No condensation)	
	Operating humidity range	Operating, Stored: 35 to 85%RH (No condensation)	
Standards	CE marking (EMC directive/ RoHS directive), UL (CSA)		
Weight	550 g		
Enclosed parts	Seal cap (for M12 connector socket) 5 pcs.		

*1 Use a CAT5 or higher communication cable.

*2 Please note that the version is subject to change.

*3 The setting file can be downloaded from SMC website, <http://www.smcworld.com>

EX500 Series

Dimensions/Parts Description

EX500-GEN2 (EtherNet/IP™)

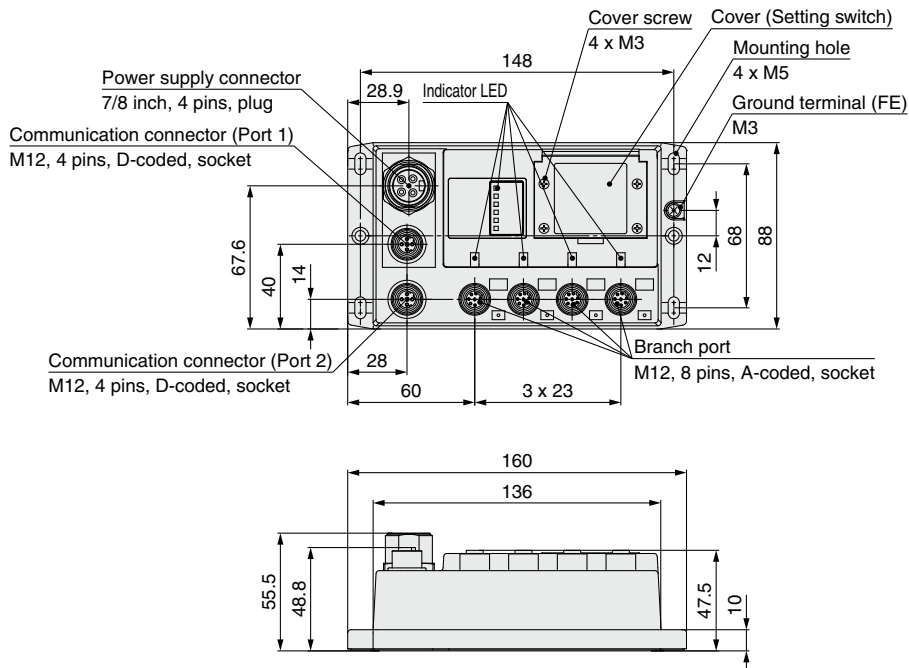

EX500-GPN2 (PROFINET)

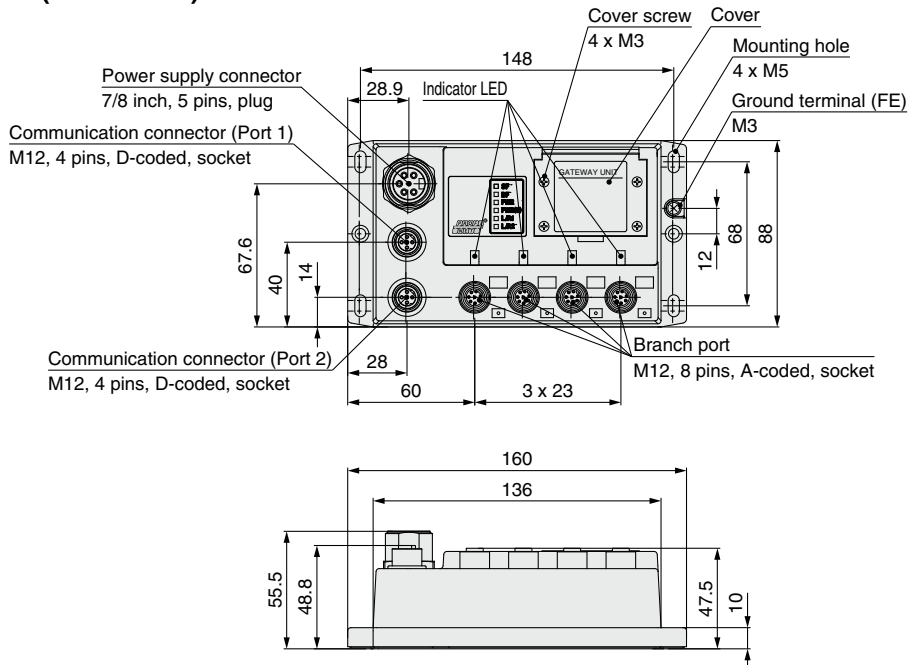

How to Order

EX500 – S103



Specifications

Model		EX500-S103
Applicable valve		SY, VQC, S0700, SV
Output	Number of outputs	16/32 outputs (Switched by built-in setting switch)
	Output type	Source/PNP (Negative common)
	Rated voltage	24 VDC
	Supply current	With power supplied to GW unit: Max. 1.0 A With external power*1 supplied: Max. 1.5 A
Internal current consumption		50 mA or less
Environmental resistance	Enclosure	IP67
	Operating temperature range	Operating: -10 to +50°C, Stored: -20 to +60°C (No condensation)
	Operating humidity range	Operating, Stored: 35 to 85%RH (No condensation)
Standards		CE marking, UL (CSA), RoHS compliant
Weight		200 g
Enclosed parts		Seal cap (for M12 connector socket) 1 pc. Valve manifold mounting screw (M3 x 30) 2 pcs.

*1 When an accessory, Y branch connector, is used.

Dimensions/Parts Description

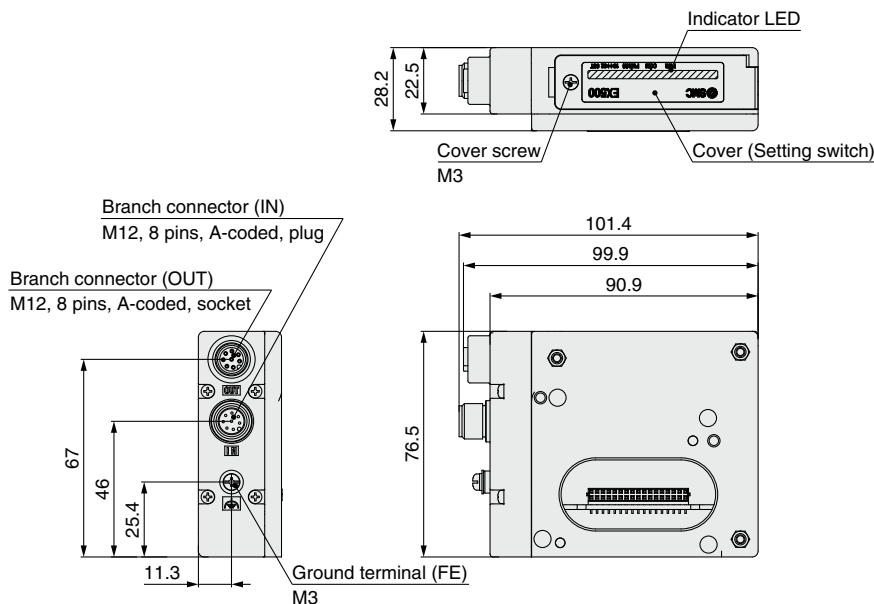

Type 1	EX260
Type 2	EX500
Type 3	EX600
	EX245
	EX250
Type 1	EX120/121/122
Type 1	EX140
	EX180
Type 2	EX510
	M8/M12
	ATEX

Gateway Decentralized System 2 (128 Points) Input Unit

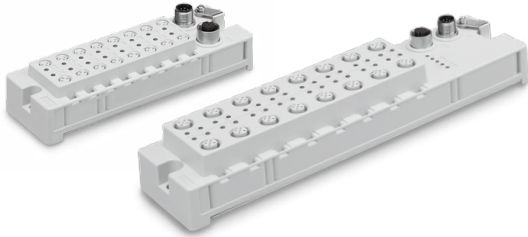

How to Order

EX500 — DX P A

Input unit

Connector type

A	M8 connector type
B	M12 connector type

Specifications

Model		EX500-DXPA	EX500-DXPB
Connector type		M8 connector	M12 connector
Input	Number of inputs	16 inputs	
	Input type	PNP sensor input	
	Rated voltage	24 VDC	
	Supply current	Max. 1.3 A/Unit [Total of 8 connectors of even number must be Max. 0.65 A, 8 connectors of odd number must be Max. 0.65 A]	
	Input ON voltage/Input ON current Input OFF voltage/Input OFF current	11 V or more/Typ. 7 mA (at 24 VDC) 5 V or less/1.5 mA or less	
Internal current consumption		200 mA or less (when the input signal is ON)	
Environmental resistance	Enclosure	IP67	
	Operating temperature range	Operating: -10 to +50°C, Stored: -20 to +60°C (No condensation)	
	Operating humidity range	Operating, Stored: 35 to 85%RH (No condensation)	
Standards		CE marking, UL (CSA), RoHS compliant	
Weight		250 g	450 g
Enclosed parts		Seal cap (for M8 connector socket) 16 pcs. Seal cap (for M12 connector socket) 1 pc.	Seal cap (for M12 connector) 17 pcs.

Dimensions/Parts Description

EX500-DXPA

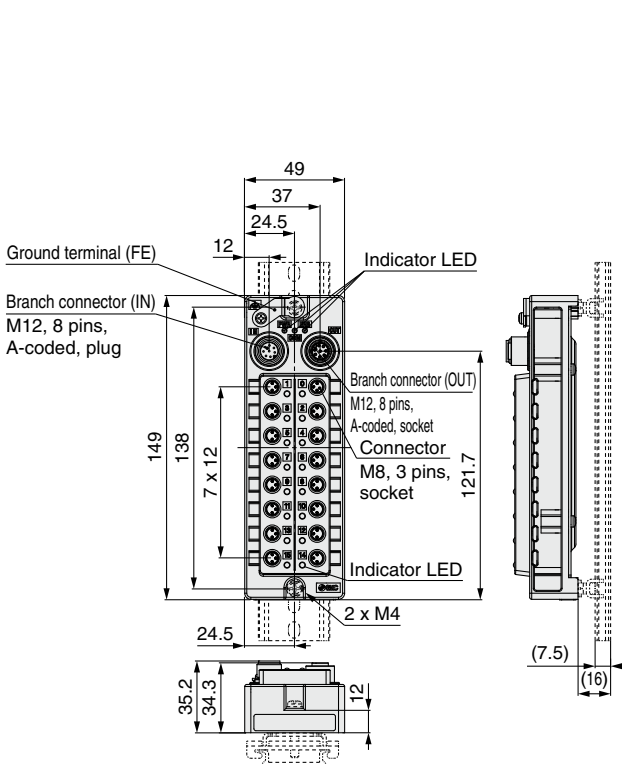

EX500-DXPB

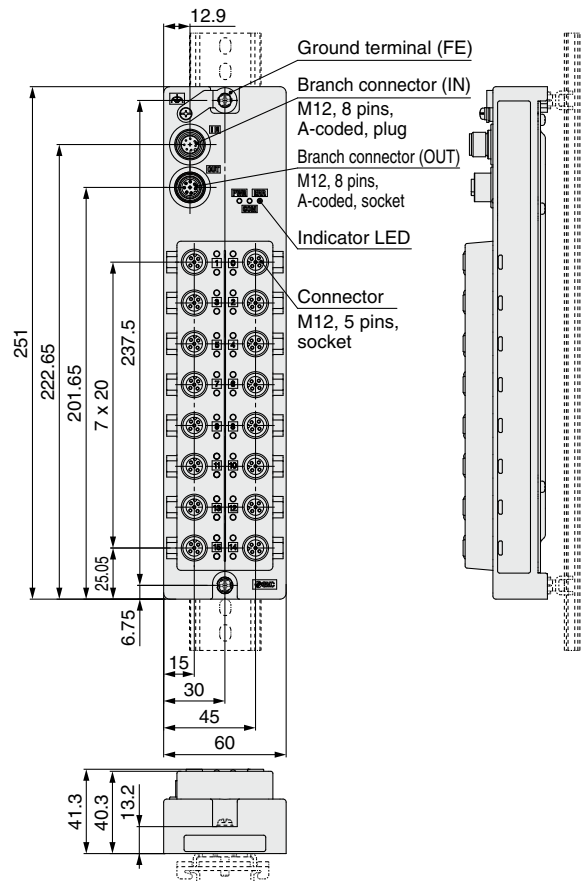

LED Indicator

EX500-GEN2

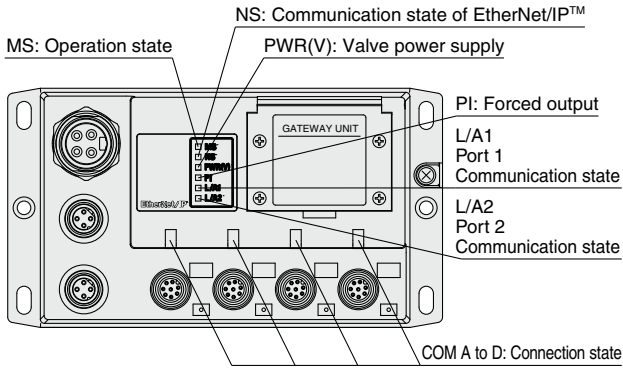

EX500-GPN2

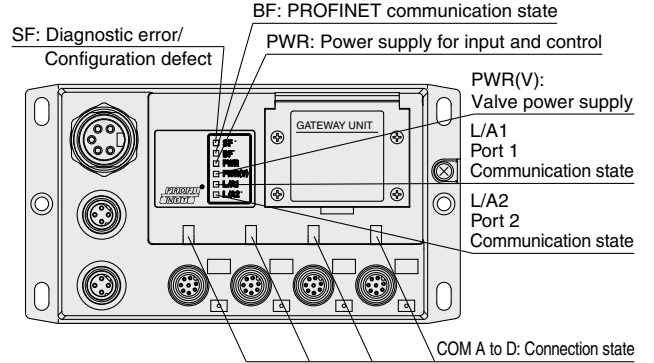

EX500-S103

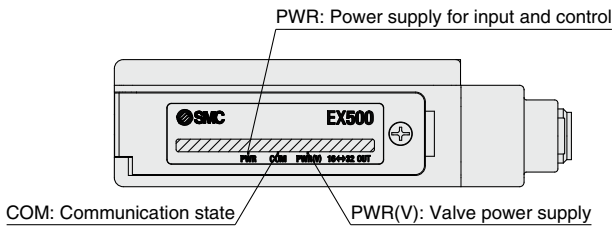

EX500-DXPA

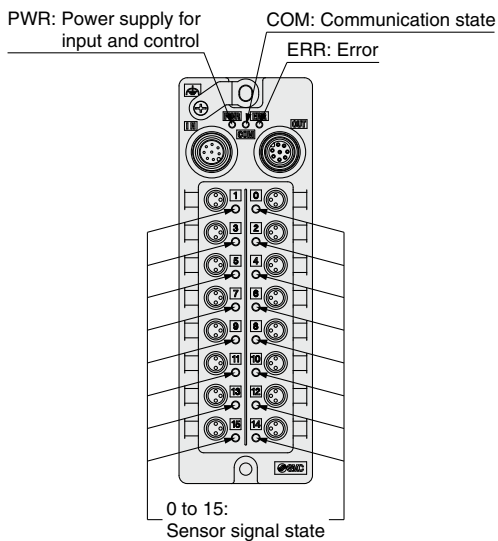

EX500-DXPB

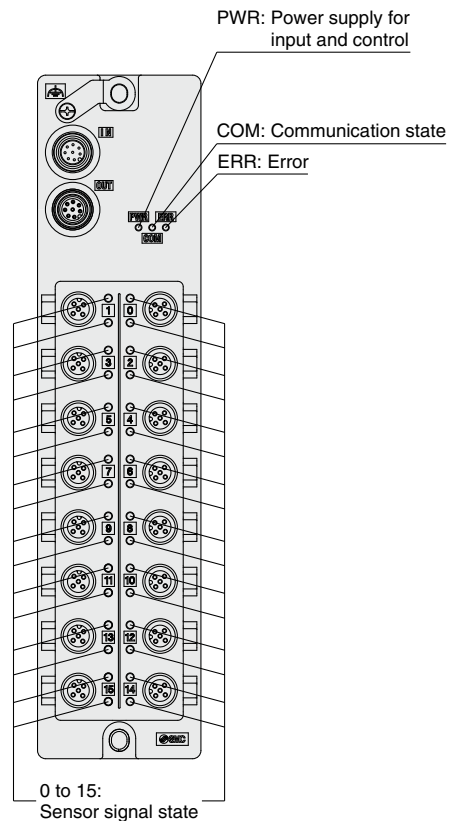

Type 1	EX260
Type 1	EX123/124/126
Type 2	EX500
Type 2	EX600
Type 3	EX245
Type 3	EX250
Type 1	EX120/121/122
Type 1	EX140
Type 1	EX180
Type 2	EX510
Type 2	M8/M12
Type 2	ATEX

Gateway Decentralized System 2 (128 Points) Accessories

① Power Supply Cable

Supplies power to the GW unit.

For PROFINET

PCA-1558810

• Connector specification, Cable length (L)

1558810	Straight 2 m
1558823	Straight 6 m
1558836	Angle 2 m
1558849	Angle 6 m

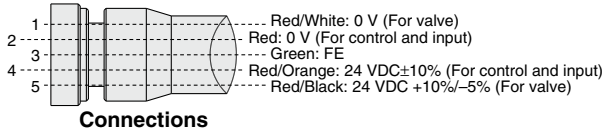
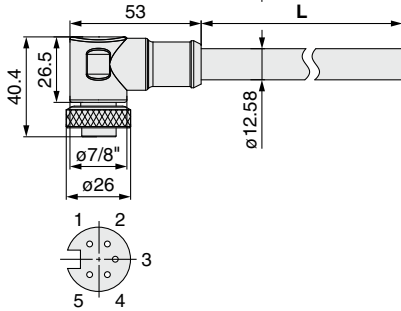
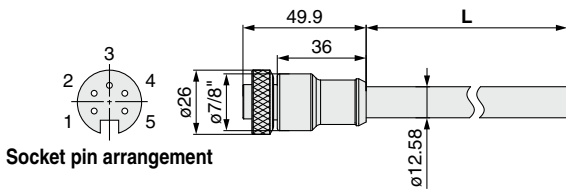

Item	Specifications
Cable O.D.	ø12.58 mm
Conductor nominal cross section	1.5 mm ² /AWG16
Wire O.D. (Including insulator)	2.35 mm
Min. bending radius (Fixed)	110 mm

For EtherNet/IP™

PCA-1416000

• Connector specification, Cable length (L)

1415999	Straight 2 m
1415996	Straight 6 m
1416000	Angle 2 m
1415997	Angle 6 m

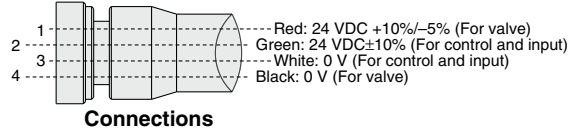
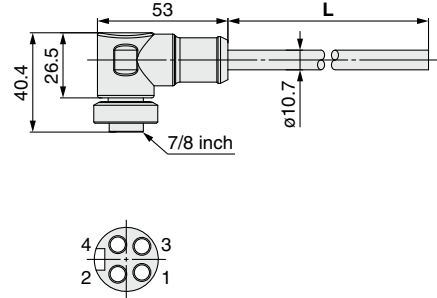
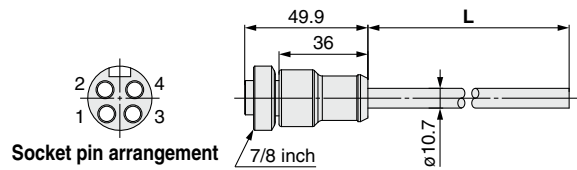

Item	Specifications
Cable O.D.	ø10.7 mm
Conductor nominal cross section	1.5 mm ² /AWG16
Min. bending radius (Fixed)	94 mm

② Communication Cable

Connects field bus to the GW unit.

For PROFINET

For EtherNet/IP™

EX9-AC 020 EN-PSRJ (Plug/RJ-45 connector)

● Cable length (L)

010	1000 mm
020	2000 mm
030	3000 mm
050	5000 mm
100	10000 mm

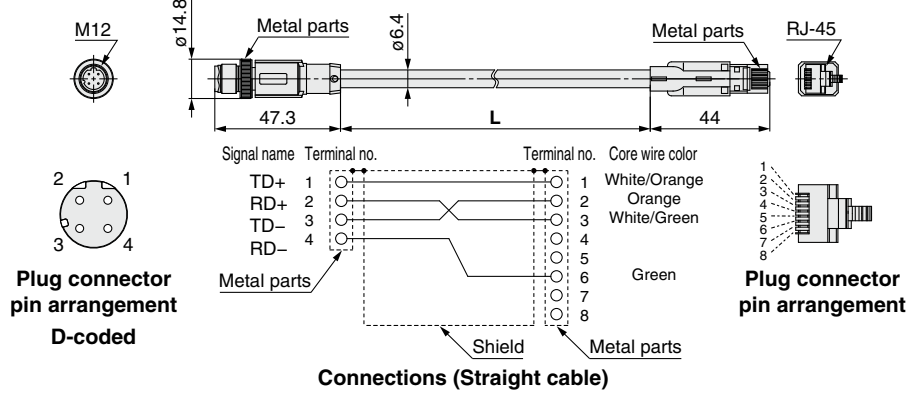

Item	Specifications
Cable O.D.	ø6.4 mm
Conductor nominal cross section	0.14 mm ² /AWG20
Wire O.D. (Including insulator)	0.98 mm
Min. bending radius (Fixed)	26 mm

PCA-1446566 (Plug)

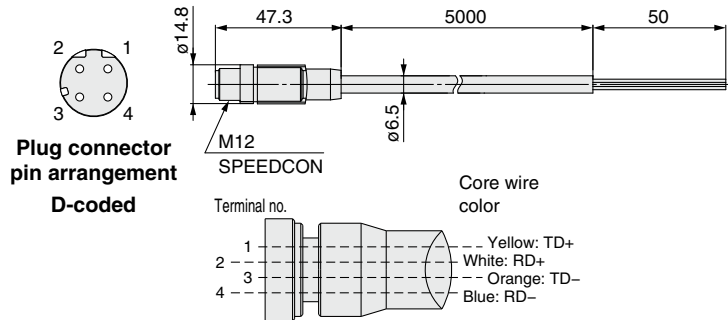

Item	Specifications
Cable O.D.	ø6.5 mm
Conductor nominal cross section	0.34 mm ² /AWG22
Wire O.D. (Including insulator)	1.55 mm
Min. bending radius (Fixed)	19.5 mm



Made to Order

Change in the cable length

p. 90

EX9-AC 005 EN-PSPS (With connector on both sides (Plug/Plug))

● Cable length (L)

005	500 mm
010	1000 mm
020	2000 mm
030	3000 mm
050	5000 mm
100	10000 mm

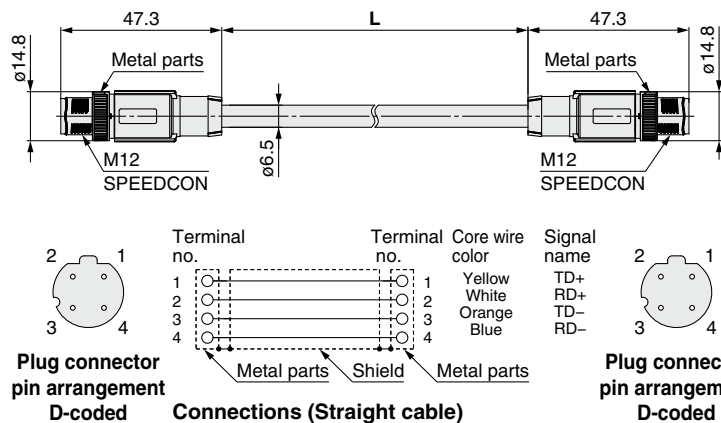

Item	Specifications
Cable O.D.	ø6.5 mm
Conductor nominal cross section	0.34 mm ² /AWG22
Wire O.D. (Including insulator)	1.55 mm
Min. bending radius (Fixed)	19.5 mm

Type 1 EX260
EX123/124/126
Type 2 EX500
EX600
Type 3 EX245
EX250
EX250
Type 1 EX120/121/122
EX140
EX180
Type 2 EX510
M8/M12
ATEX

EX500 Series

② Communication Cable

For PROFINET For EtherNet/IP™

EX9-AC **005** EN-PAPA (With angle connector on both sides (Plug/Plug))

● Cable length (L)

005	500 mm
010	1000 mm
020	2000 mm
030	3000 mm
050	5000 mm
100	10000 mm

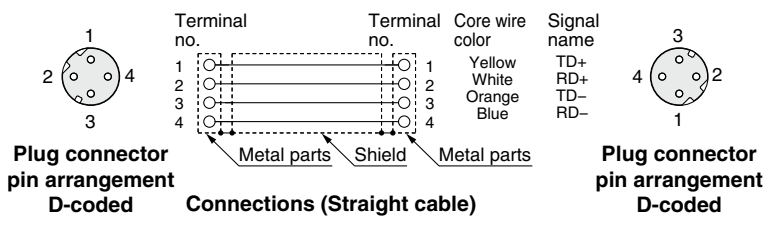
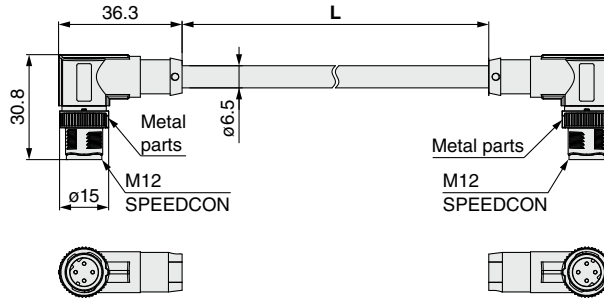

Item	Specifications
Cable O.D.	ø6.5 mm
Conductor nominal cross section	0.34 mm ² /AWG22
Wire O.D.(Including insulator)	1.55 mm
Min. bending radius (Fixed)	19.5 mm

③ Field-wireable Communication Connector

For PROFINET For EtherNet/IP™

PCA-1446553

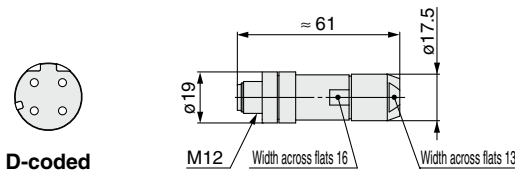

Applicable Cable

Item	Specifications
Cable O.D.	4.0 to 8.0 mm
Wire gauge (Stranded wire cross section)	0.14 to 0.34 mm ² /AWG26 to 22

* The table above shows the specifications for the applicable cable. Adaptation for the connector may vary on account of the conductor construction of the electric wire.

EX500 Series

4 Branch Cable

Connects the GW unit and SI unit or input unit.

EX500-AC 030 - SSPS

Cable length (L)

003	300 mm
005	500 mm
010	1000 mm
030	3000 mm
050	5000 mm
100	10000 mm

Connector specification

SSPS	Socket side: Straight, Plug side: Straight
SAPA	Socket side: Angle, Plug side: Angle

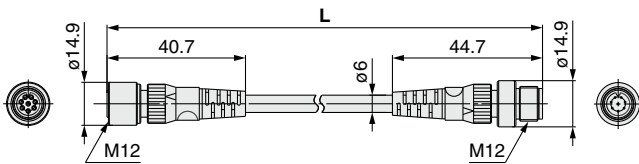

A-coded

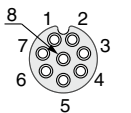

Socket pin arrangement

A-coded

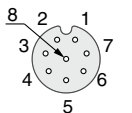

Plug pin arrangement

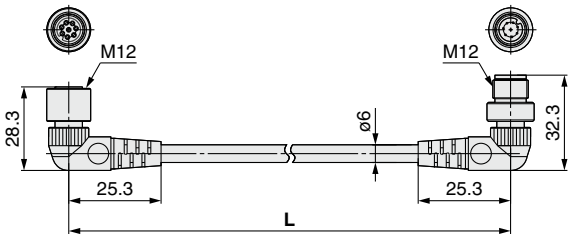

A-coded

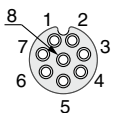

Socket pin arrangement

A-coded

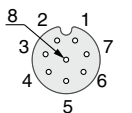

Plug pin arrangement

Item	Specifications
Cable O.D.	φ6 mm
Conductor nominal cross section	0.25 mm ²
Wire O.D. (Including insulator)	1.27 mm
Min. bending radius (Fixed)	40 mm

5 Y Branch Connector

Supplies separate power to valve manifold when it is connected to the SI unit.

EX500-ACY01-S

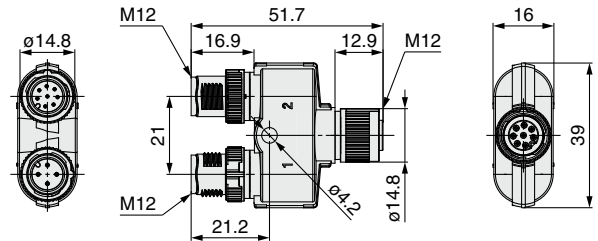

A-coded



Plug pin arrangement

Pin Layout of the Cable for Power Supply from a Different System

1	24 VDC +10%, -5% (for valve)
2	0 VDC (for valve)
3	Unused
4	Unused

<Example of use>

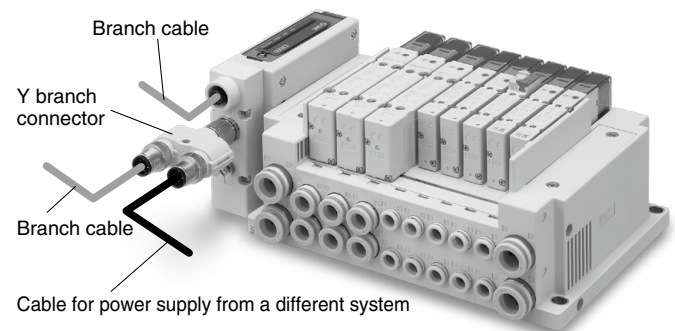

⑥ Cable for Power Supply from a Different System

Connect to Y branch connector to supply power.

For PROFINET For EtherNet/IP™

EX500-AP 050 - S

Cable length (L)

010	1000 mm
050	5000 mm

Connector specification

S	Straight
A	Angle

Straight connector type

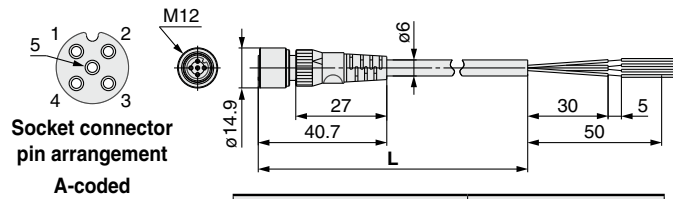

Item	Specifications
Cable O.D.	ø6 mm
Conductor nominal cross section	0.3 mm ² /AWG22
Wire O.D. (Including insulator)	1.5 mm
Min. bending radius (Fixed)	40 mm

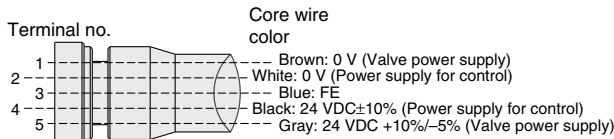

Connections (PROFINET)

Angle connector type

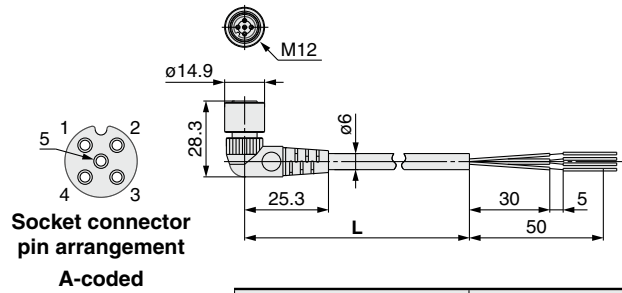

Item	Specifications
Cable O.D.	ø6 mm
Conductor nominal cross section	0.3 mm ² /AWG22
Wire O.D. (Including insulator)	1.5 mm
Min. bending radius (Fixed)	40 mm

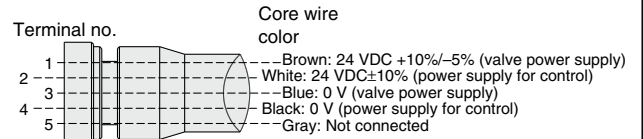

Connections (EtherNet/IP™)



Made to Order

Cable length	10000 mm	p. 91
--------------	----------	-------

PCA-1401804

Cable length (L)

1401804	1500 mm
1401805	3000 mm
1401806	5000 mm

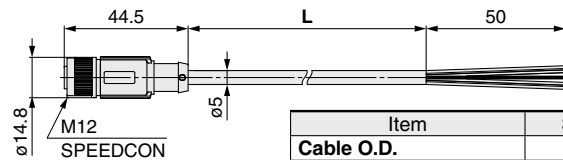
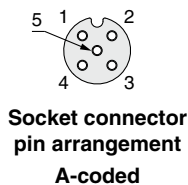

Item	Specifications
Cable O.D.	ø5 mm
Conductor nominal cross section	0.34 mm ² /AWG22
Wire O.D. (Including insulator)	1.27 mm
Min. bending radius (Fixed)	21.7 mm

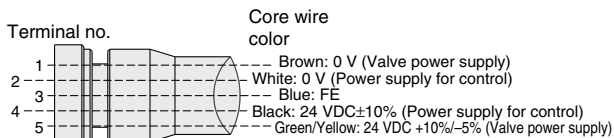

Connections (PROFINET)

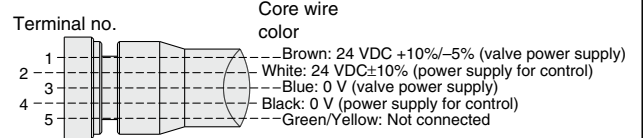

Connections (EtherNet/IP™)

⑦ DIN Rail Bracket (2 pcs.)

Bracket for mounting the input unit (EX500-DXPA, EX500-DXPB) to DIN rail.

EX500-ZMA1

<Example of use>

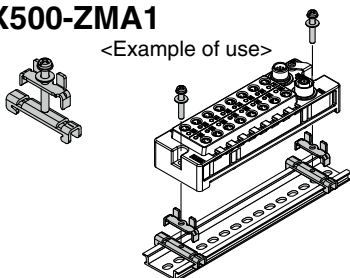

⑧ Marker (1 sheet, 88 pcs.)

Signal name of the input device such as a switch can be written on the marker and installed to the input unit.

EX600-ZT1

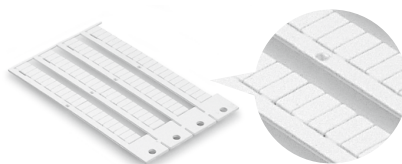

⑨ Seal Cap (10 pcs.)

Use with new connector. By using these seal caps, the new connector maintains IP65/67 enclosure.

EX9-AWES
For M8 connector socket

EX9-AWTS
For M12 connector socket



Type 1	EX260
Type 2	EX123/124/126
Type 2	EX500
Type 2	EX600
Type 3	EX245
Type 3	EX250
Type 1	EX120/121/122
Type 1	EX140
Type 1	EX180
Type 2	EX510
Type 2	M8/M12
Type 2	ATEX

EX500 Series

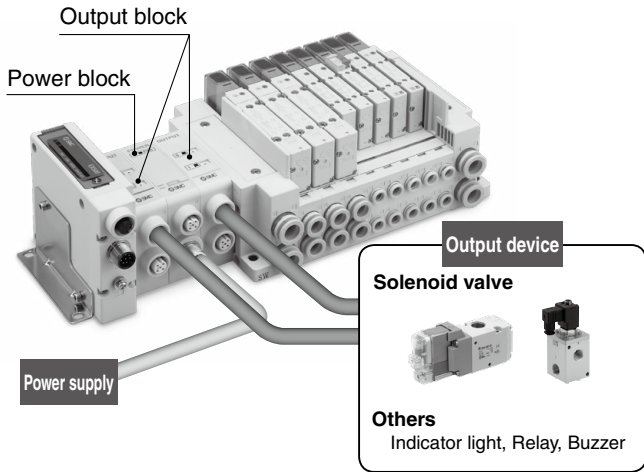

- Output devices other than valve manifold can be operated.
- By using the power block and output block for high watt load, operation up to 0.5 A/point can be performed.
- Possible to mount the output block and power block additionally between the SI unit and the valve (The surplus I/O points are used).
- 2 point outputs per output block (M12 connector)

You are requested to connect it to an SI unit and a valve manifold. For detailed specifications, refer to the operation manual that can be downloaded from SMC website, <http://www.smcworld.com>

⑩ Output Block

EX9-OE T 1

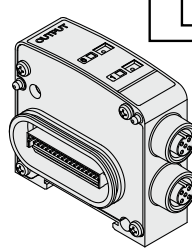

● Output specification

1 Source/PNP (Negative common)

● Power supply type

T	Internal power supply method (for low-wattage load)
P	Integrated power supply method (for high-wattage load) *1

*1 Required to connect with a power block

Dimensions/Parts Description

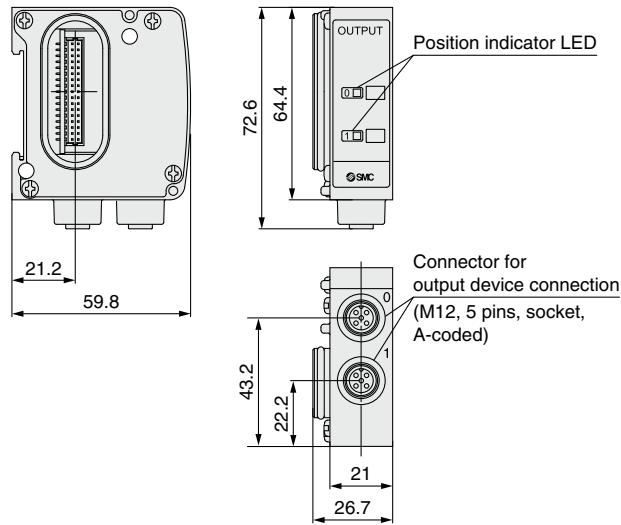

⑪ Power Block

EX9-PE1

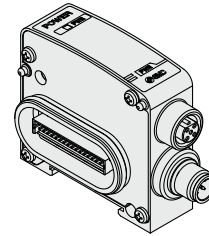

Dimensions/Parts Description

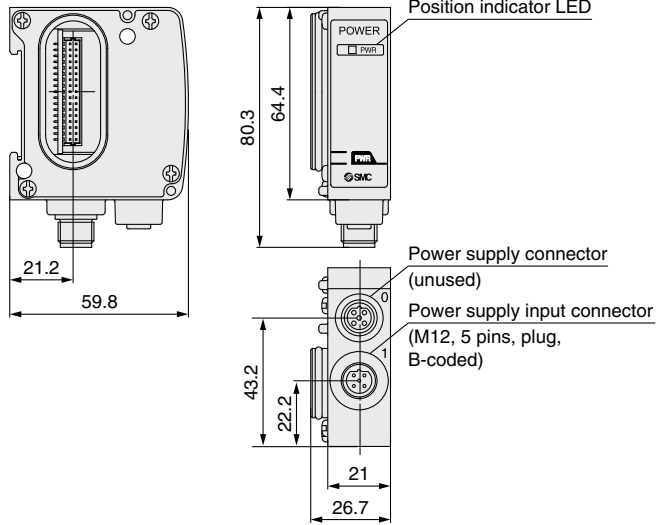

Specifications

Model		EX9-OET1	EX9-OEP1
Internal current consumption		40 mA or less	
Output	Output type	Source/PNP (Negative common)	
	Number of outputs	2 outputs	
	Power supply method	Internal power supply method	Integrated power supply method (Power block: supplied from EX9-PE1)
	Output device supply voltage	24 VDC	
	Output device supply current	Max. 42 mA/point (1.0 W/point)	Max. 0.5 A/point (12 W/point)
Environmental resistance	Enclosure	IP67	
	Operating temperature range	-10 to 50°C	
	Operating humidity range	35 to 85%RH (No condensation)	
Standards		CE marking, UL (CSA), RoHS compliant	
Weight		120 g	

Specifications

Model		EX9-PE1
Connection block		Output block for high wattage load
Connection block stations		Output block: Max. 8 stations
Power supply for output and internal control	Power supply voltage	22.8 to 26.4 VDC
	Internal current consumption	20 mA or less
Supply current		Max. 3.1 A *1
Environmental resistance	Enclosure	IP67
	Operating temperature range	-10 to 50°C
Standards		35 to 85%RH (No condensation)
Weight		120 g
Enclosed parts		Seal cap (for M12 connector) 1 pc.

*1 When using with 3.0 to 3.1 A, the ambient temperature should not exceed 40°C, and do not bundle the cable.

⑫ Power Supply Cable (For power block)

Supplies power to the power block.

Straight connector type

EX9-AC 050 - 1

● Cable length (L)

010	1000 mm
030	3000 mm
050	5000 mm

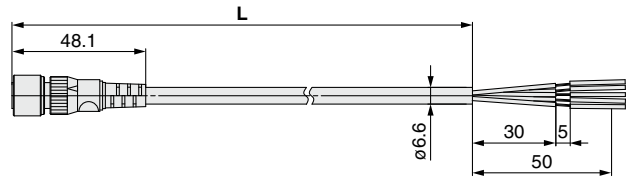
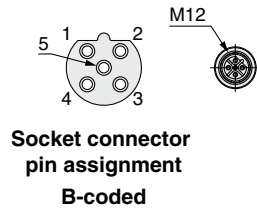

Item	Specifications
Cable O.D.	ø6.6 mm
Conductor nominal cross section	0.3 mm ² /AWG22
Wire O.D. (Including insulator)	1.65 mm
Min. bending radius (Fixed)	40 mm



Made to Order

Cable length	10000 mm	p. 91
--------------	----------	-------

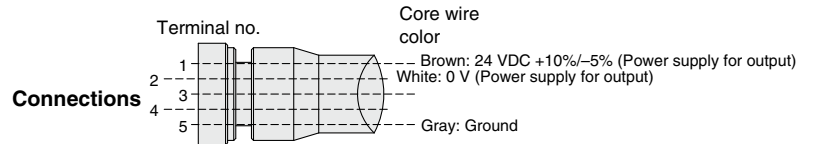

PCA-1401807

● Cable length (L)

1401807	1500 mm
1401808	3000 mm
1401809	5000 mm

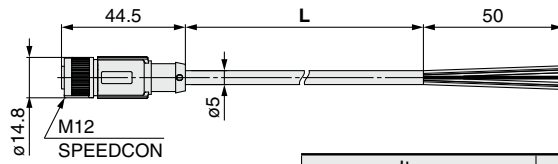
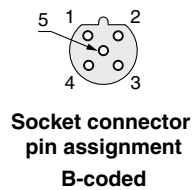

Item	Specifications
Cable O.D.	ø5 mm
Conductor nominal cross section	0.34 mm ² /AWG22
Wire O.D. (Including insulator)	1.27 mm
Min. bending radius (Fixed)	21.7 mm

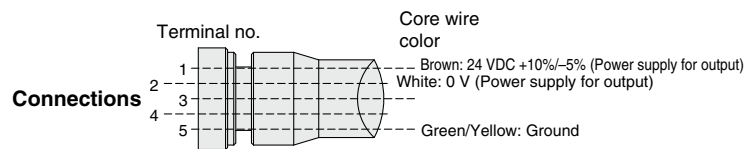

Type 1	EX260
Type 2	EX500
Type 3	EX600
Type 1	EX245
Type 1	EX250
Type 1	EX120/121/122
Type 1	EX140
Type 1	EX180
Type 2	EX510
	M8/M12
	ATEX

EX500 Series

13 Connector for Output Block Wiring

Field-wireable connector for connecting an output device to an output block

PCA-1557743

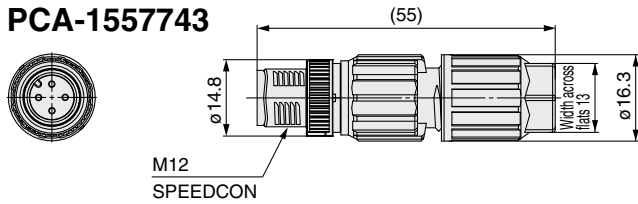

A-coded

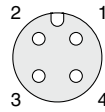

Plug pin arrangement

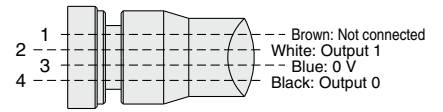

Connections

Applicable Cable

Item	Specifications
Cable O.D.	3.5 to 6.0 mm
Wire gauge (Stranded wire cross section)	0.14 to 0.34 mm ² /AWG26 to 22
Core wire diameter (Including insulating material)	0.7 to 1.3 mm

PCA-1557756

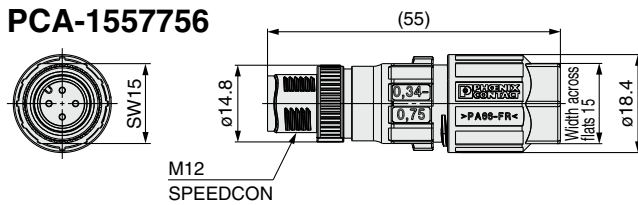

A-coded

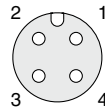

Plug pin arrangement

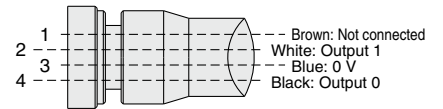

Connections

Applicable Cable

Item	Specifications
Cable O.D.	4.0 to 8.0 mm
Wire gauge (Stranded wire cross section)	0.34 to 0.75 mm ² /AWG22 to 18
Core wire diameter (Including insulating material)	1.3 to 2.5 mm

14 End Plate

Use when an output block is not being used and a valve manifold is not connected.

EX9-EA03

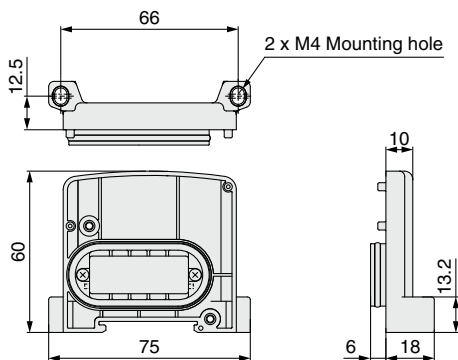

<Example of use>

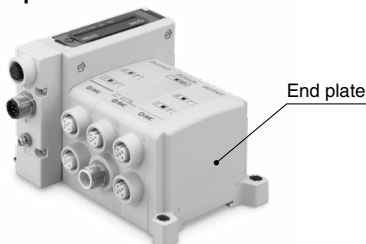

15 Bracket Plate/DIN Rail Mounting Bracket

A reinforcing brace used to mount an output block or power block onto an SI unit
To prevent connection failure between products due to deflection, use this bracket plate whenever an output block or power block is mounted.

EX9-BP1

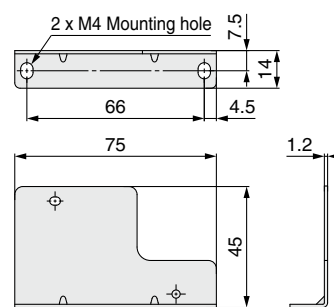

EX9-BD1

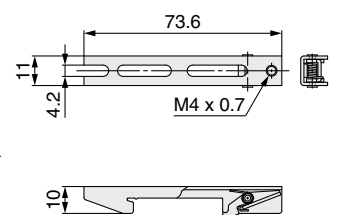

Accessory

Accessory

Description	Qty.
Hexagon socket head cap screw (M3 x 35)	2

Description	Qty.
Domed cap nut (M4)	1
Round head combination screw (M4 x 8)	1
Round head combination screw (M4 x 10)	1

<Example of use>

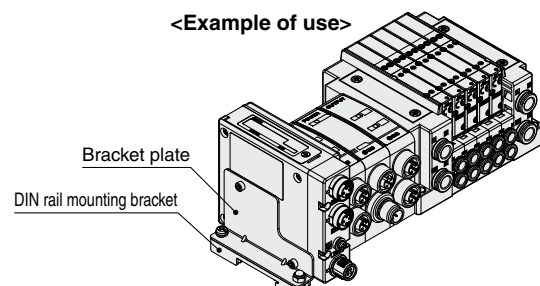



Precautions on Mixed Usage of Gateway Decentralized System 2 (128 Points) and Gateway Decentralized System (64 Points)

		GW Unit	
		Gateway Decentralized System 2 (128 points) • EX500-GEN2 • EX500-GPN2	Gateway Decentralized System (64 points) • EX500-GDN1 • EX500-GPR1A
SI Unit Input Unit	Gateway Decentralized System 2 (128 points) • EX500-S103 • EX500-DX□□	Usable	Usable Same functions of Gateway Decentralized System (64 points)
	Gateway Decentralized System (64 points) • EX500-S001 • EX500-Q001/002 • EX500-Q101/102 • EEX500-IB1-□ (EX500-IB1)	Usable Same functions of Gateway Decentralized System (64 points)	Usable

Type 1	EX260
Type 1	EX123/124/126
Type 2	EX500
Type 2	EX600
Type 3	EX245
Type 3	EX250
Type 1	EX120/121/122
Type 1	EX140
Type 1	EX180
Type 2	EX510
Type 2	M8/M12
Type 2	ATEX

Fieldbus System

Gateway Decentralized System (64 Points)

EX500 Series

CE  US
 * Only the SY and SV valves are UL-compliant.

 RoHS

- ★ Valve manifolds and input units can be connected around the GW (Gateway) unit.
- ★ Compatible with other protocols by replacing the GW unit
- ★ Number of inputs/outputs = 64 points/64 points. The number of outputs (solenoids) per branch is 16 points.
- ★ Number of valve manifold connections = Max. 4 units, Number of input unit connections = Max. 4 units, Cable length = Max. 10 m
- ★ No need to set the address for the valve manifolds or input units

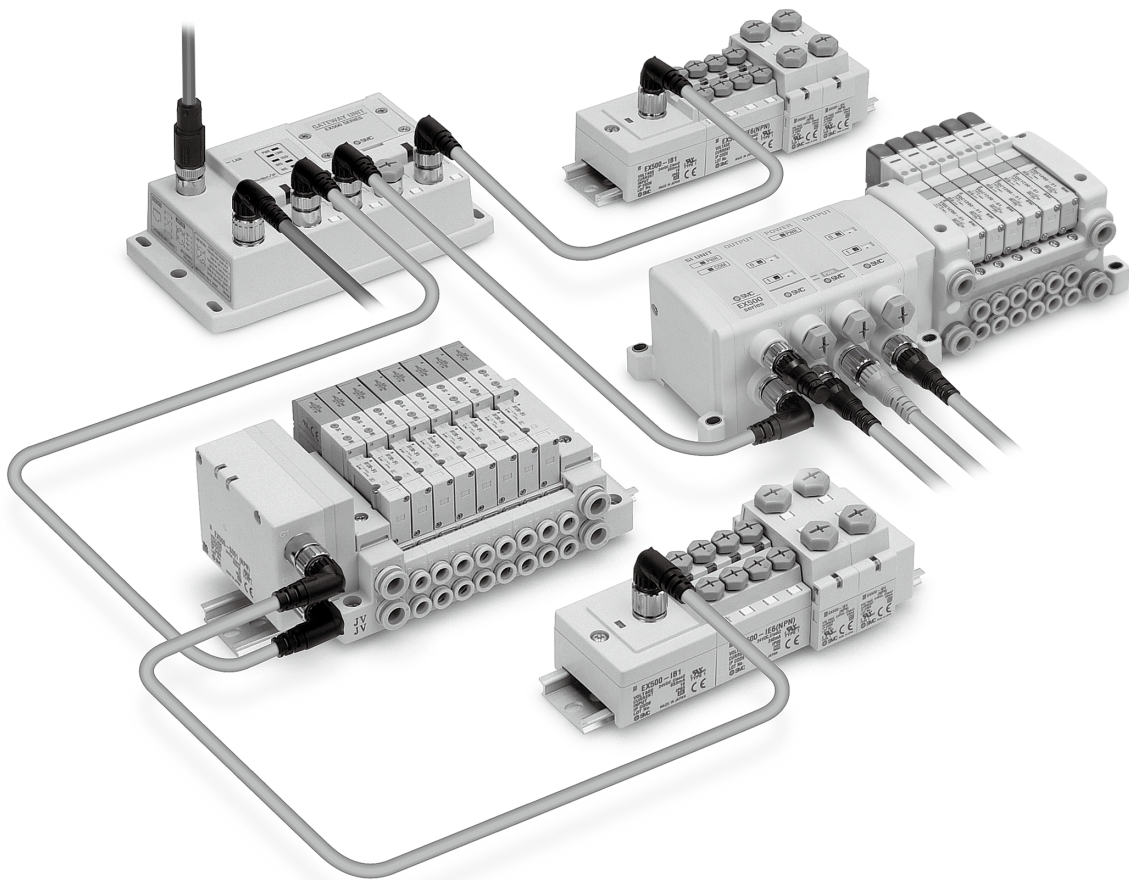

Manifold Solenoid Valves

SY3000/5000/7000

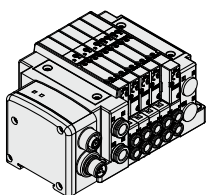

VQC1000/2000/4000/5000

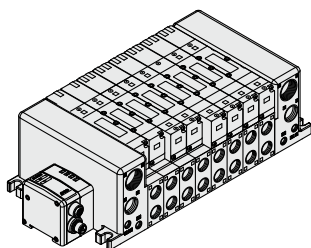

S0700

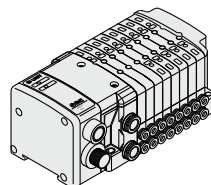

SV1000/2000/3000

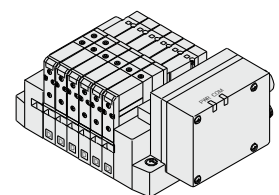

How to Order



EX500 – G DN1

Protocol

DN1	DeviceNet™ (Input/Output = 64 points/64 points)
PR1A	PROFIBUS DP (Input/Output = 64 points/64 points)

Specifications

Model	EX500-GDN1	EX500-GPR1A	
Communication	Protocol	DeviceNet™	PROFIBUS DP
	Version *1	Release 2.0	DP-V0
	Communication speed	125 k/250 k/500 kbps	9.6 k/19.2 k/45.45 k/ 93.75 k/187.5 k/500 k/ 1.5 M/3 M/6 M/12 Mbps
	Configuration file *2	EDS file	GSD file
	Number of inputs/outputs (I/O occupation area)	64 inputs/64 outputs (8 bytes/8 bytes)	
	Terminating resistor	Not provided	Built into the unit
Power supply voltage	For control	11 to 25 VDC (Supplied by DeviceNet™ circuit, 50 mA or less)	24 VDC ±10%
	For input device	24 VDC ±10%	
	For valve	24 VDC +10%, -5%	
Current consumption	For input and control	3.0 A or less (Max. 0.7 A per branch x 4 branches + GW unit internal current consumption: 0.2 A or less)	
	For valve	3.0 A or less (Max. 0.75 A per branch x 4 branches)	
Branch port	Number of branch ports	4 ports	
	Number of inputs and outputs	16 inputs/16 outputs per branch	
	Branch cable length	5 m or less between connected devices (10 m or less per branch)	
Environmental resistance	Enclosure	IP65	
	Operating temperature range	Operating: 5 to 45°C, Stored: -25 to 70°C (No freezing or condensation)	
	Operating humidity range	Operating, Stored: 35 to 85%RH (No condensation)	
Standards	CE marking (EMC directive/ RoHS directive), UL (CSA)		
Weight	470 g		
Enclosed parts	Seal cap (for M12 connector)	4 pcs.	Seal cap (for M12 connector)
			5 pcs.

*1 Please note that the version is subject to change.

*2 The setting file can be downloaded from SMC website, <http://www.smcworld.com>

Dimensions/Parts Description

EX500-GDN1 (DeviceNet™)

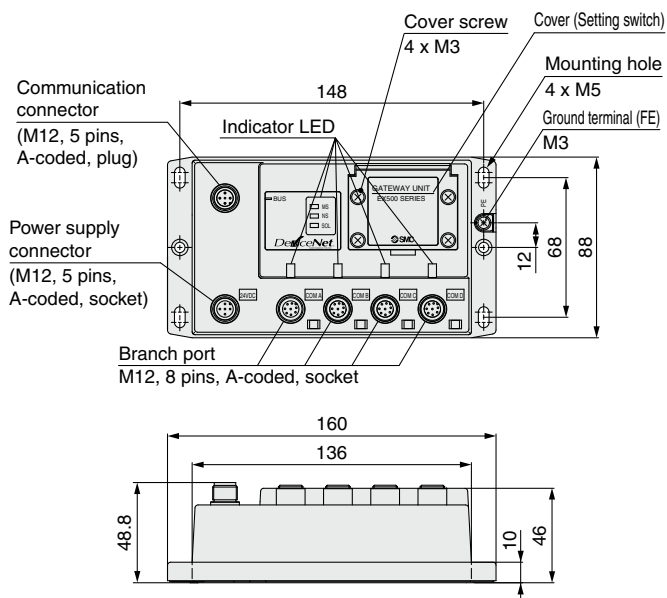

EX500-GPR1A (PROFIBUS DP)

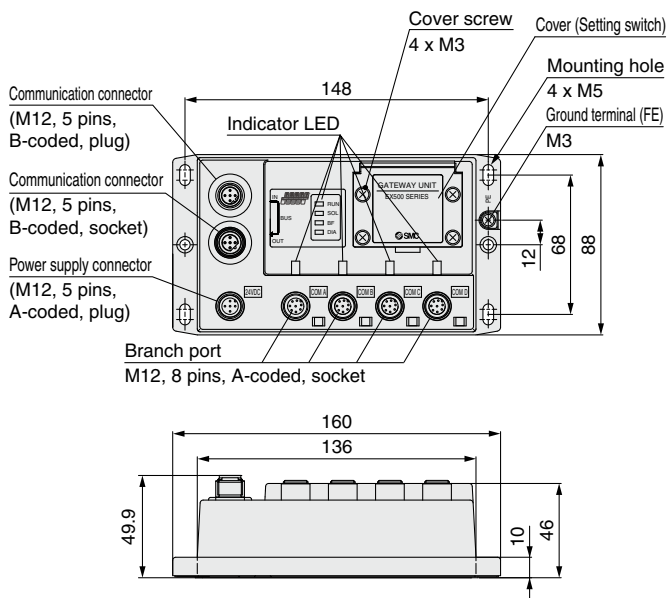

Type 1	EX260
Type 2	EX500
Type 3	EX600
	EX245
	EX250
Type 1	EX120/121/122
	EX140
Type 2	EX180
	EX510
	M8/M12
	ATEX

How to Order

For SV1000/2000/3000/4000

EX500 – S001

• Applicable valve:
SV series

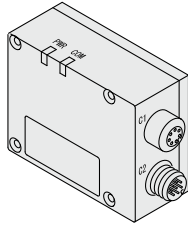

Specifications

Model		EX500-S001
Output	Number of outputs	16 outputs
	Output type	Sink/NPN (Positive common)
	Supply current	Max. 0.65 A
	Rated voltage	24 V
Internal current consumption		100 mA or less
Environmental resistance	Enclosure	IP67
	Operating temperature range	Operating: 5 to 45°C, Stored: -25 to 70°C (No freezing or condensation)
	Operating humidity range	Operating, Stored: 35 to 85%RH (No condensation)
Standards		CE marking, UL (CSA), RoHS compliant
Weight		115 g
Enclosed parts		Seal cap (for M12 connector socket) 1 pc.

Dimensions/Parts Description

EX500-S001

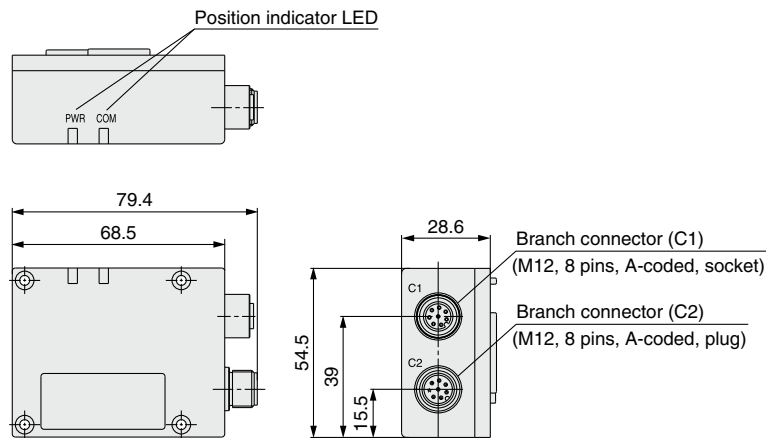

How to Order

For SY3000/5000/7000,
VQC1000/2000/4000/5000,
S0700

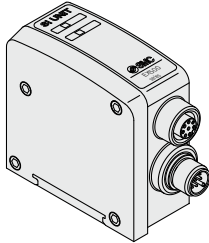

EX500-Q001

Applicable valve: ●
SY/VQC/S0700 series

Output specification ●

0	NPN (Positive common)
1	PNP (Negative common)

SI unit type ●

1	For without EX9 output block
2	For EX9 output block mounting

Specifications

Model		EX500-Q001	EX500-Q101	EX500-Q002	EX500-Q102
Output	Number of outputs	16 outputs			
	Output type	Sink/NPN (Positive common)	Source/PNP (Negative common)	Sink/NPN (Positive common)	Source/PNP (Negative common)
	Rated voltage	24 VDC			
	Supply current	Max. 0.75 A			
Internal current consumption		100 mA or less			
Environmental resistance	Enclosure	IP67			
	Operating temperature range	Operating: 5 to 45°C, Stored: -25 to 70°C (No freezing or condensation)			
	Operating humidity range	Operating, Stored: 35 to 85%RH (No condensation)			
Standards		CE marking, RoHS compliant			
Weight		105 g			
Enclosed parts		Seal cap (for M12 connector socket) 1 pc.			

Dimensions/Parts Description

EX500-Q□01

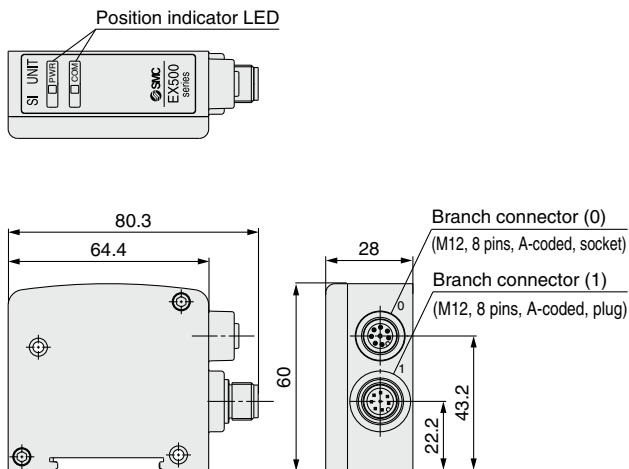

EX500-Q□02

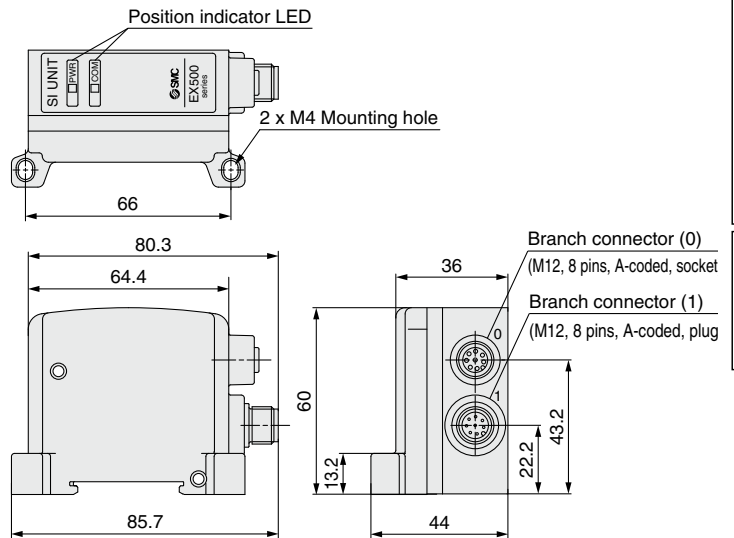

Type 1	EX260
Type 1	EX123/124/126
Type 2	EX500
Type 3	EX600
Type 3	EX245
Type 3	EX250
Type 1	EX120/121/122
Type 1	EX140
Type 1	EX180
Type 2	EX510
Type 2	M8/M12
Type 2	ATEX

How to Order Input Manifold

How to Order Input Block



EEX500-IB1-E8

Connector type

E	M8 connector
T	M12 connector
M	M8, M12 mixed

Stations

1	1 station
:	:
8	8 stations

EX500-IE1

Block type

1	M8 connector, 2 inputs, PNP specification
2	M8 connector, 2 inputs, NPN specification
3	M12 connector, 2 inputs, PNP specification
4	M12 connector, 2 inputs, NPN specification
5	M8 connector, 8 points integrated type, PNP specification
6	M8 connector, 8 points integrated type, NPN specification

Input Manifold

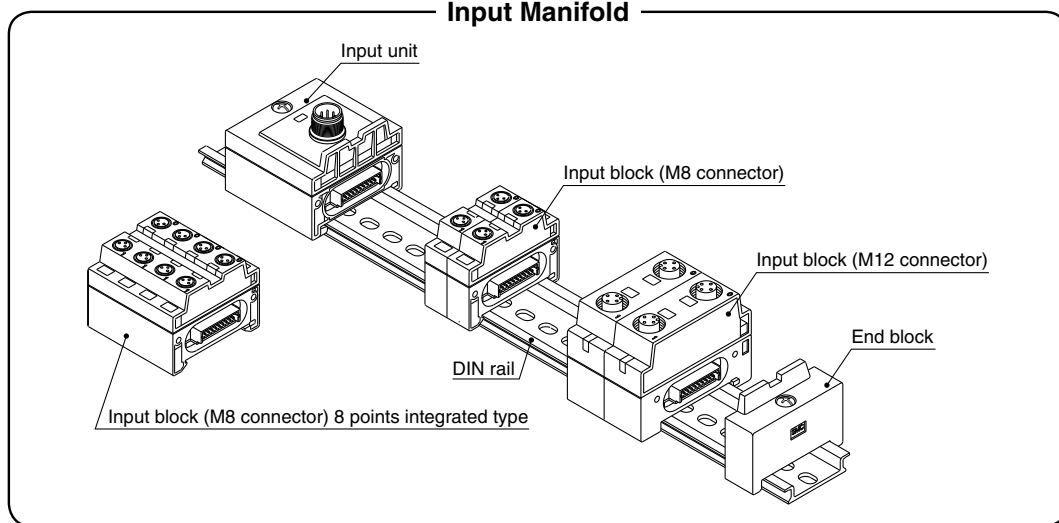

How to Order Input Manifold [Ordering Example]

When ordering an input unit manifold, enter the [Input manifold part number] + [Input block part number].

Please mention the connected input block part numbers in order from the input unit side under the input manifold part number.

When an input block layout becomes complicated, indicate in the input unit manifold specification sheet.

* The [Input unit], [End block] and [DIN rail] are included in the input manifold.

Example 1) M8 Input block only

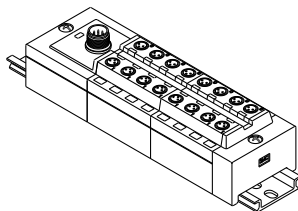

EEX500-IB1-E8 1 set
* EX500-IE5 2 sets*1

Example 2) M12 Input block only

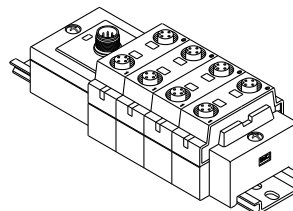

EEX500-IB1-T4 1 set
* EX500-IE4 4 sets

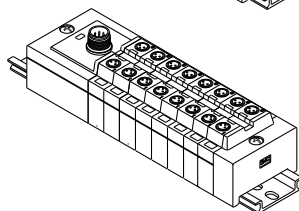

EEX500-IB1-E8 1 set
* EX500-IE1 8 sets

Example 3) M8, M12 mixed

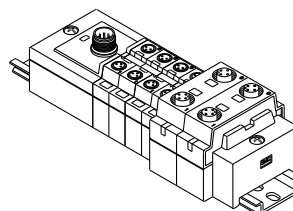

EEX500-IB1-M6 1 set
* EX500-IE1 4 sets
* EX500-IE3 2 sets

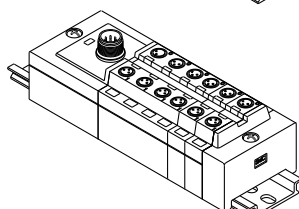

EEX500-IB1-E6 1 set
* EX500-IE5 1 set*1
* EX500-IE1 2 sets

*1 8-point integrated type input block (EX500-IE5/6) is equivalent to 4 stations of 2-point input block (EX500-IE1/2).

Specifications (Input Unit)

Model		EX500-IB1
Input	Number of inputs	16 inputs
	Connection block	EX500-IE□ (Mixed combination is possible.)
	Connection block stations	2-input, input block: Max. 8 stations 8-input, input block: Max. 2 stations
Internal current consumption		100 mA or less
Environmental resistance	Enclosure	IP65
	Operating temperature range	Operating: 5 to 45°C, Stored: -25 to 70°C (No freezing or condensation)
	Operating humidity range	Operating, Stored: 35 to 85%RH (No condensation)
Standards		CE marking, UL (CSA), RoHS compliant
Weight		100 g (Input unit + End block)

Specifications (Input Block)

Model		EX500-IE1	EX500-IE2	EX500-IE3	EX500-IE4	EX500-IE5	EX500-IE6
Input	Connector type	M8 (3 pins)		M12 (4 pins)		M8 (3 pins)	
	Input type	PNP sensor input	NPN sensor input	PNP sensor input	NPN sensor input	PNP sensor input	NPN sensor input
	Number of inputs	2 inputs				8 inputs	
	Input device supply voltage	24 VDC					
	Input device supply current	Max. 480 mA/Input unit manifold					
	Rated input current	Approx. 5 mA					
Environmental resistance	Enclosure	IP65					
	Operating temperature range	Operating: 5 to 45°C, Stored: -25 to 70°C (No freezing and condensation)					
	Operating humidity range	Operating, Stored: 35 to 85%RH (No condensation)					
Standards		CE marking, UL (CSA), RoHS compliant					
Weight		20 g		40 g		55 g	
Enclosed parts		Seal cap (for M8 connector) 2 pcs.		Seal cap (for M12 connector) 2 pcs.		Seal cap (for M8 connector) 8 pcs.	

Type 1	EX260
Type 1	EX123/124/126
Type 2	EX500
Type 3	EX600
Type 3	EX245
Type 3	EX250
Type 1	EX120/121/122
Type 1	EX140
Type 1	EX180
Type 2	EX510
Type 2	M8/M12
Type 2	ATEX

EX500 Series

Dimensions/Parts Description

Input block (M8) only

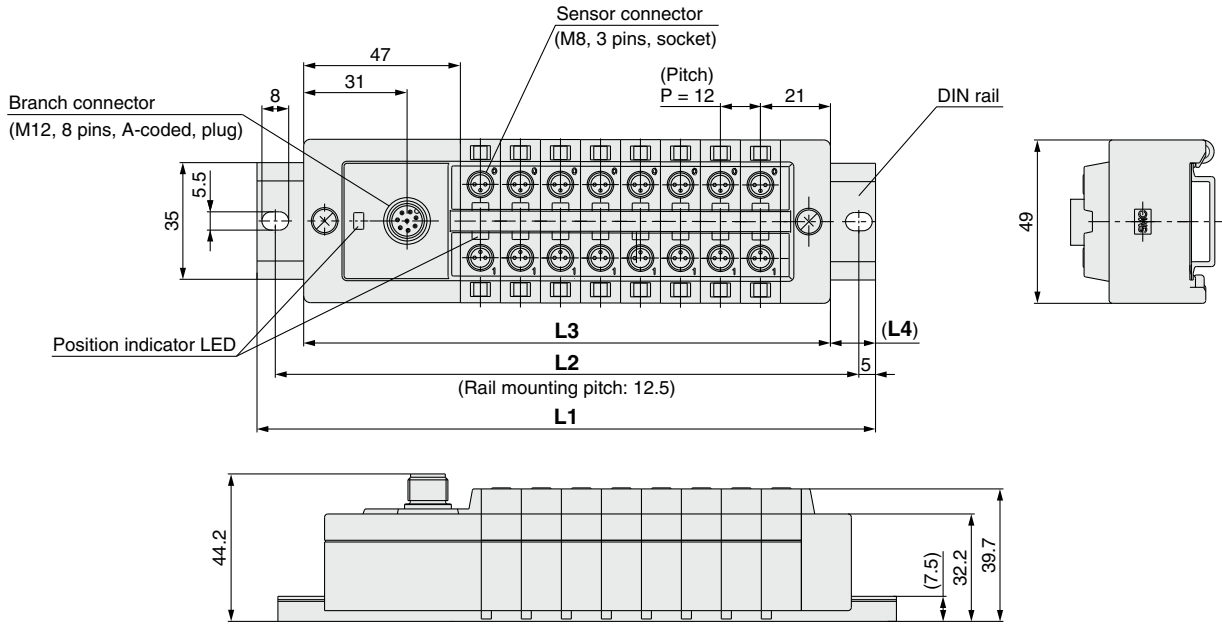

	[mm]							
Stations	1	2	3	4	5	6	7	8
Rail length L1	98	110.5	123	135.5	148	160.5	173	185.5
Mounting pitch L2	87.5	100	112.5	125	137.5	150	162.5	175
Manifold length L3	74	86	98	110	122	134	146	158
L4	12	12	12.5	12.5	13	13	13.5	13.5

Input block (M12) only

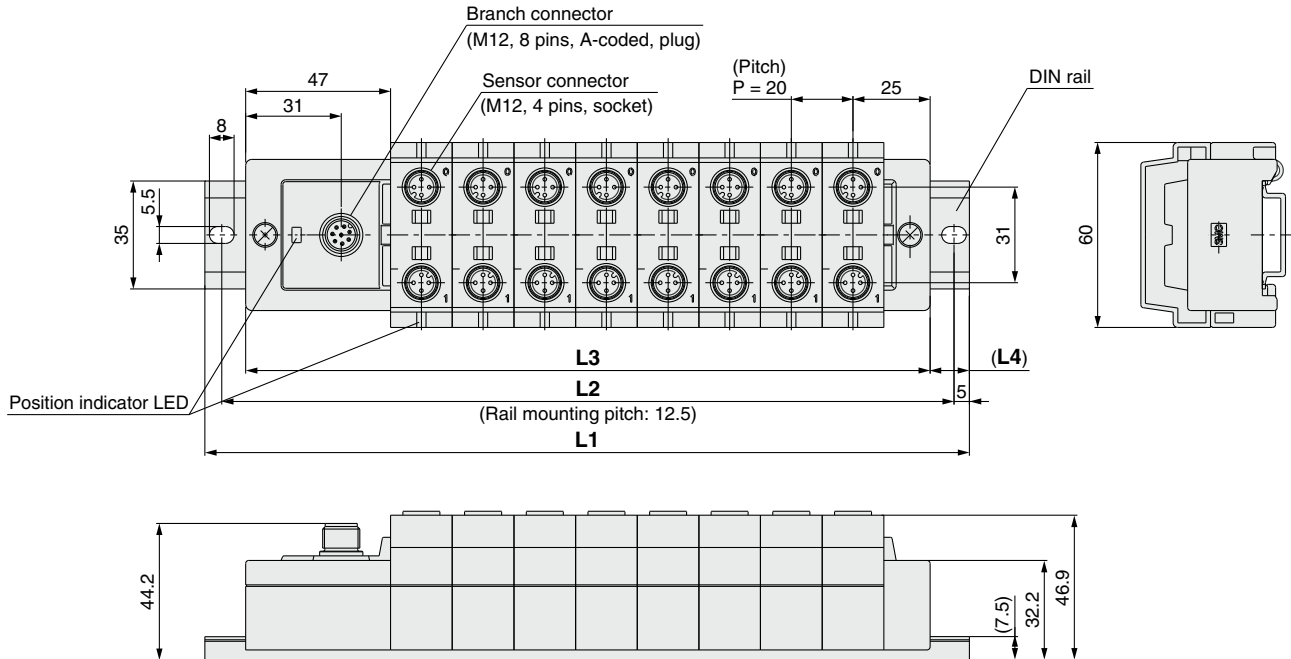

	[mm]							
Stations	1	2	3	4	5	6	7	8
Rail length L1	110.5	123	148	173	185.5	210.5	223	248
Mounting pitch L2	100	112.5	137.5	162.5	175	200	212.5	237.5
Manifold length L3	82	102	122	142	162	182	202	222
L4	12	12	12.5	12.5	13	13	13.5	13.5

How to Add Input Block Stations

How to add input block stations

1. Loosen the round head combination screws (2 places) that hold the end block.
 2. Separate the blocks at the locations where stations are to be added.
 3. Attach the additional blocks to the DIN rail, and connect the blocks so that they fit together securely.
 4. While holding the blocks together so that there are no gaps between them, secure them to the DIN rail by tightening the round head combination screws.
- Note: Be sure to tighten the round head combination screw with the prescribed tightening torque. (0.6 N·m)

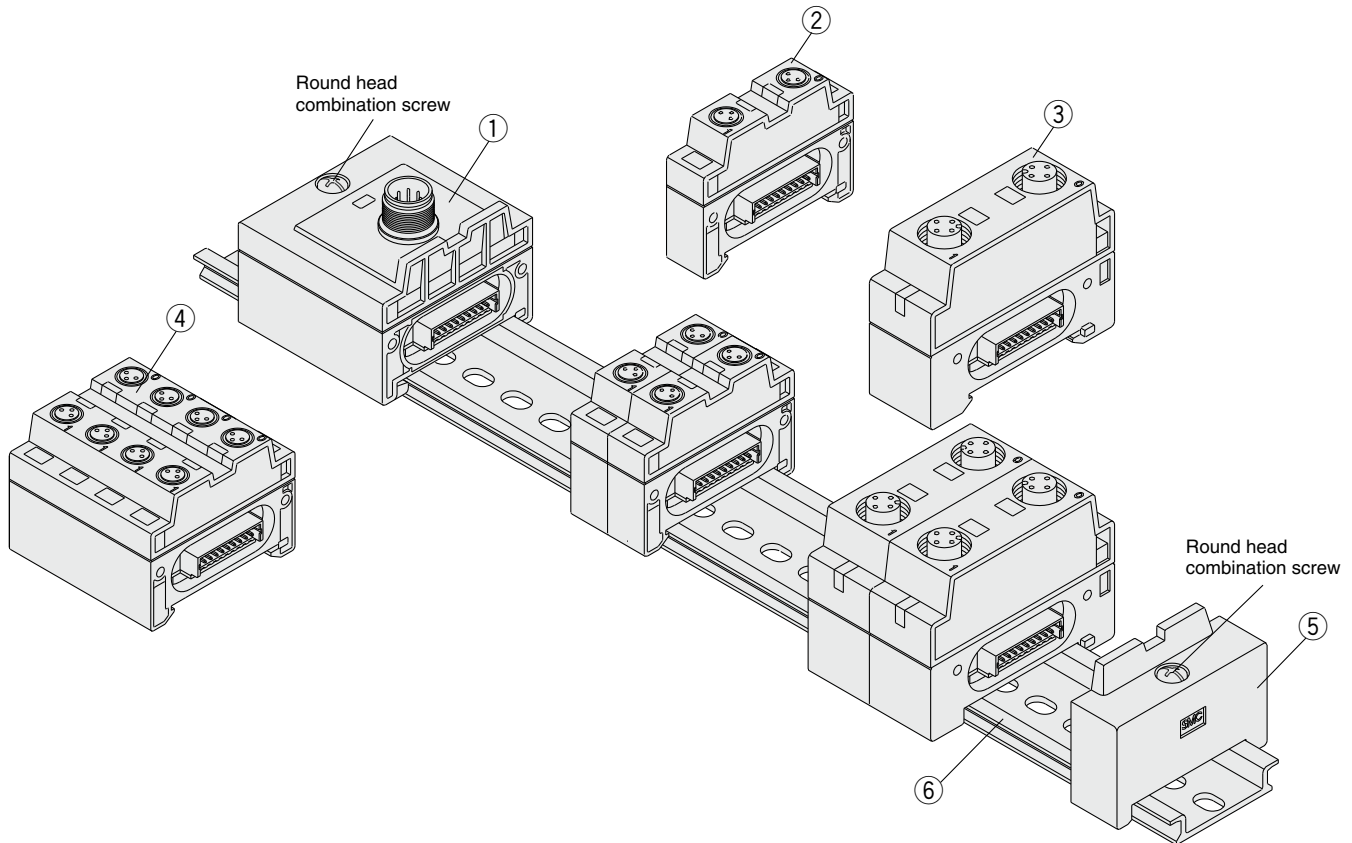

Parts List

No.	Description	Part number	Note
		For standard	
①	Input unit	EX500-IB1	
②	Input block (M8 connector)	EX500-IE□	PNP Specification...□: 1, NPN Specification...□: 2
③	Input block (M12 connector)	EX500-IE□	PNP Specification...□: 3, NPN Specification...□: 4
④	Input block (M8 connector) 8 points integrated type	EX500-IE□	PNP Specification...□: 5, NPN Specification...□: 6
⑤	End block	EX500-EB1	
⑥	DIN rail	VZ1000-11-1-□	□: Number based on L dimension (Refer to the table below.)

DIN Rail L Dimensions [mm]

Stations	M8 input block (m)								Connector type For E (m = 1 to 8)	No.	L dimension	No.	L dimension
	0	1	2	3	4	5	6	7					
M12 input block (n)	0	1	2	3	4	5	6	7	8	0	98	7	185.5
	1	2	3	4	5	6	7	8	1	110.5	8	198	
	2	3	4	5	6	7	8	2	123	9	210.5		
	3	4	5	6	7	8	9	3	135.5	10	223		
	4	5	6	7	8	9	4	148	11	235.5			
	5	6	7	8	10	5	160.5	12	248				
	6	7	8	11	6	173							
	7	8	11										
	8	12											

Connector type
For M (m + n = 2 to 8)

Connector type
For T (n = 1 to 8)

L dimensions

Type 1	EX260
Type 2	EX500
Type 3	EX600
Type 1	EX123/124/126
Type 2	EX245
Type 3	EX250
Type 1	EX120/121/122
Type 1	EX140
Type 1	EX180
Type 2	EX510
Type 1	M8/M12
Type 1	ATEX

EX500 Series

LED Indicator

EX500-GDN1

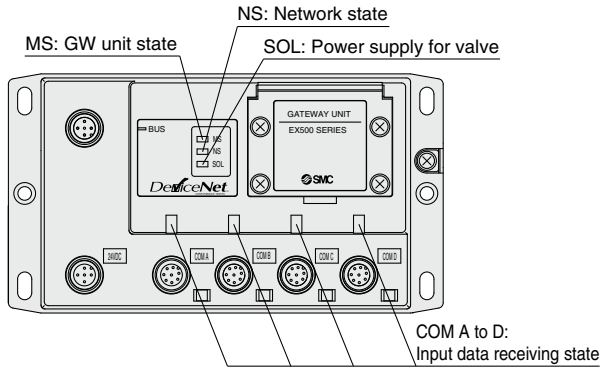

EX500-GPR1A

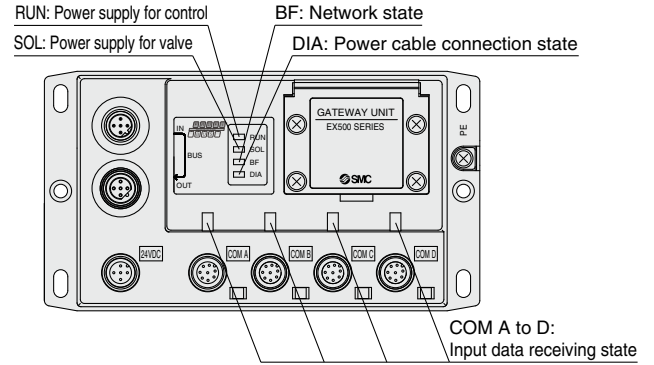

EX500-Q□□□

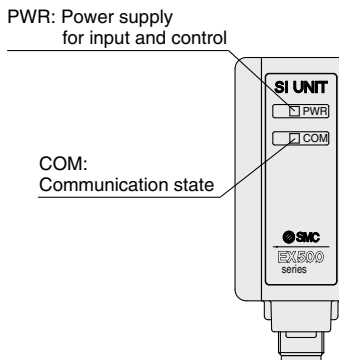

EX500-S001

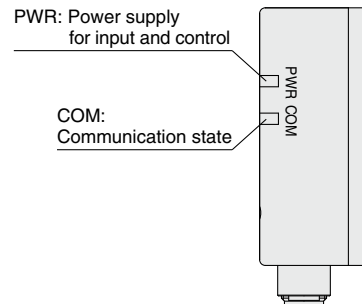

EX500-IB1

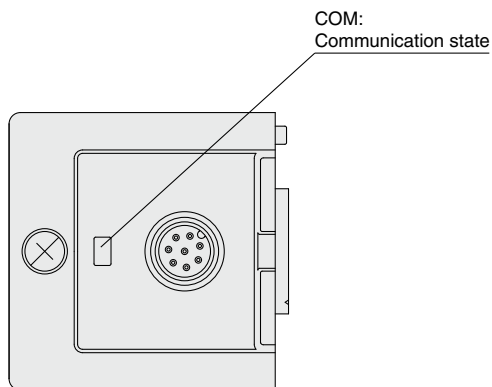

EX500-IE□

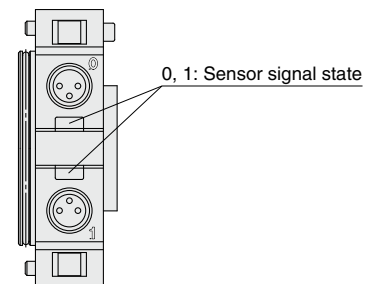

Gateway Decentralized System (64 Points) Accessories

① Communication Cable

For DeviceNet™

EX500-AC **050** -DN
(Socket)

Cable length (L)

010	1000 mm
050	5000 mm

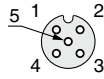

Socket connector
pin assignment
A-coded (Normal key)

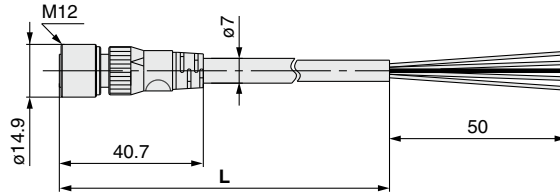

Connections

Item		Specifications
Cable O.D.		ø7 mm
Conductor nominal cross section	Power pair	0.3 mm ² /AWG22
	Data pair	0.2 mm ² /AWG24
Wire O.D. (Including insulator)	Power pair	1.5 mm
	Data pair	1.9 mm
Min. bending radius (Fixed)		60 mm

PCA-1557633
(Socket)

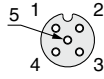

Socket connector
pin assignment
A-coded (Normal key)

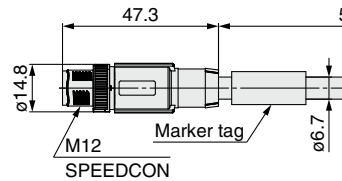
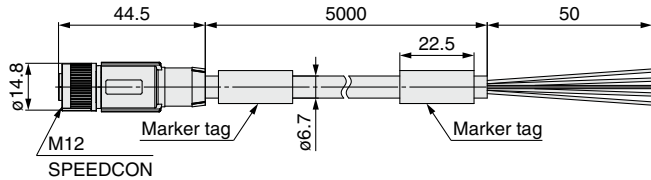

Connections

Item		Specifications
Cable O.D.		ø6.7 mm
Conductor nominal cross section	Power pair	0.34 mm ² /AWG22
	Data pair	0.25 mm ² /AWG24
Wire O.D. (Including insulator)	Power pair	1.4 mm
	Data pair	2.05 mm
Min. bending radius (Fixed)		67 mm

PCA-1557646
(Plug)

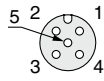

Plug connector
pin assignment
A-coded (Normal key)

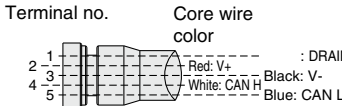
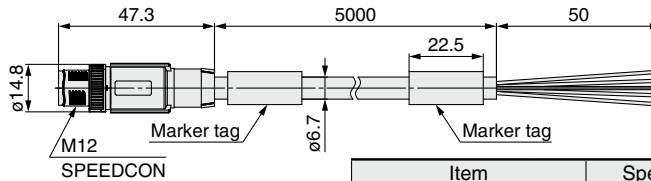

Connections

Item		Specifications
Cable O.D.		ø6.7 mm
Conductor nominal cross section	Power pair	0.34 mm ² /AWG22
	Data pair	0.25 mm ² /AWG24
Wire O.D. (Including insulator)	Power pair	1.4 mm
	Data pair	2.05 mm
Min. bending radius (Fixed)		67 mm



Made to Order

Cable length	10000 mm	p. 89
--------------	----------	-------

Type 1
EX260
EX123/124/126

Type 2
EX500

Type 3
EX600

EX245

EX250

Type 1
EX120/121/122

Type 1
EX140

EX180

Type 2
EX510

M8/M12

ATEX

EX500 Series

① Communication Cable

For DeviceNet™

EX9-AC 005 DN-SSPS (With connector on both sides (Socket/Plug))

● Cable length (L)

005	500 mm
010	1000 mm
020	2000 mm
030	3000 mm
050	5000 mm
100	10000 mm

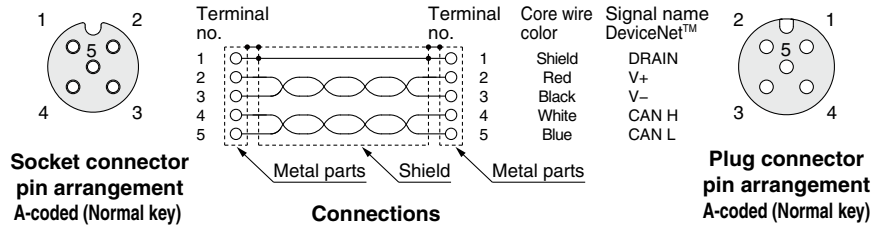
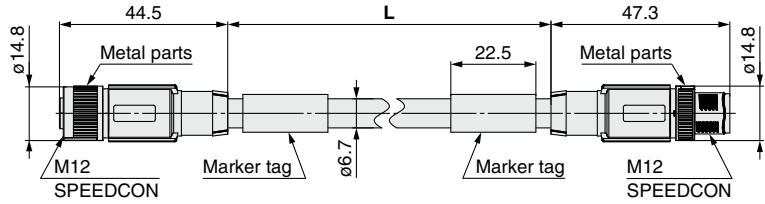

Item	Specifications	
Cable O.D.	ø6.7 mm	
Conductor nominal cross section	Power pair	0.34 mm ² /AWG22
	Data pair	0.25 mm ² /AWG24
Wire O.D. (Including insulator)	Power pair	1.4 mm
	Data pair	2.05 mm
Min. bending radius (Fixed)	67 mm	

EX9-AC 005 DN-SAPA (With angle connector on both sides (Socket/Plug))

● Cable length (L)

005	500 mm
010	1000 mm
020	2000 mm
030	3000 mm
050	5000 mm
100	10000 mm

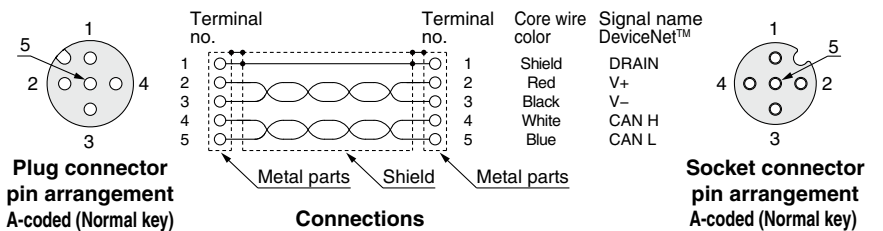
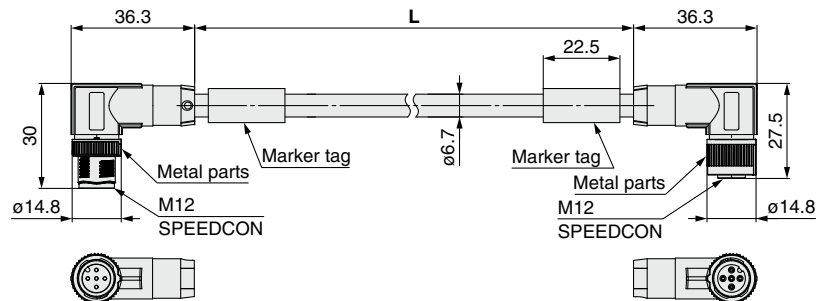

Item	Specifications	
Cable O.D.	ø6.7 mm	
Conductor nominal cross section	Power pair	0.34 mm ² /AWG22
	Data pair	0.25 mm ² /AWG24
Wire O.D. (Including insulator)	Power pair	1.4 mm
	Data pair	2.05 mm
Min. bending radius (Fixed)	67 mm	

EX500 Series

① Communication Cable

For PROFIBUS DP

PCA-1557688
(Socket)

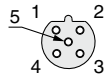

Socket connector
pin assignment
B-coded (Reverse key)

PCA-1557691
(Plug)

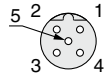

Plug connector
pin assignment
B-coded (Reverse key)

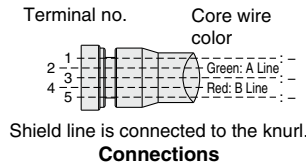
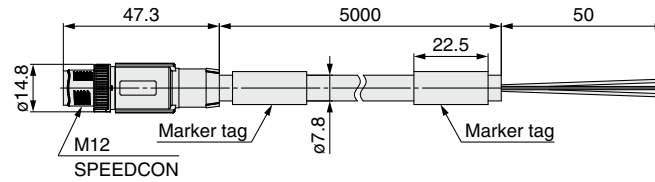
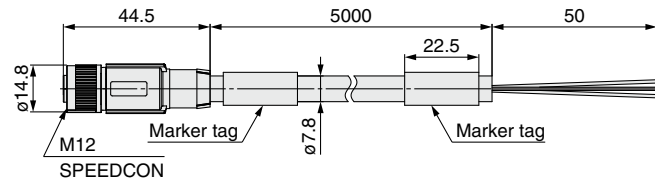

Item	Specifications
Cable O.D.	ø7.8 mm
Conductor nominal cross section	0.34 mm ² /AWG22
Wire O.D. (Including insulator)	2.55 mm
Min. bending radius (Fixed)	78 mm

② Field-wireable Communication Connector

Plug

For DeviceNet™

PCA-1075528



A-coded
(Normal key)

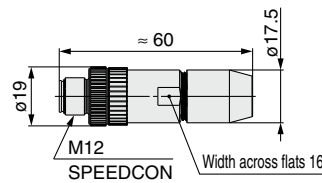

Applicable Cable

Item	Specifications
Cable O.D.	4.0 to 8.0 mm
Wire gauge (Stranded wire cross section)	0.14 to 0.75 mm ² /AWG26 to 18 (Solid cable/Flexible cable) 0.08 to 0.5 mm ² /AWG28 to 20 (With ferrule)

For PROFIBUS DP

PCA-1075530



B-coded
(Reverse key)

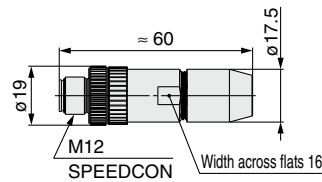

Applicable Cable

Item	Specifications
Cable O.D.	4.0 to 8.0 mm
Wire gauge (Stranded wire cross section)	0.14 to 0.75 mm ² /AWG26 to 18 (Solid cable/Flexible cable) 0.08 to 0.5 mm ² /AWG28 to 20 (With ferrule)

Socket

For DeviceNet™

PCA-1075529



A-coded
(Normal key)

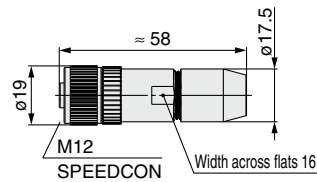

Applicable Cable

Item	Specifications
Cable O.D.	4.0 to 8.0 mm
Wire gauge (Stranded wire cross section)	0.14 to 0.75 mm ² /AWG26 to 18 (Solid cable/Flexible cable) 0.08 to 0.5 mm ² /AWG28 to 20 (With ferrule)

For PROFIBUS DP

PCA-1075531



B-coded
(Reverse key)

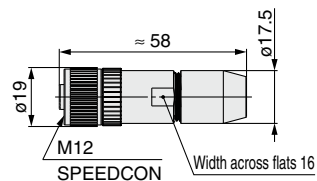

Applicable Cable

Item	Specifications
Cable O.D.	4.0 to 8.0 mm
Wire gauge (Stranded wire cross section)	0.14 to 0.75 mm ² /AWG26 to 18 (Solid cable/Flexible cable) 0.08 to 0.5 mm ² /AWG28 to 20 (With ferrule)

③ Power Supply Cable

For PROFIBUS DP For DeviceNet™

EX500-AP **050** - **S**

Cable length (L)

010	1000 mm
050	5000 mm

Connector specification

S	Straight
A	Angle

Straight connector type

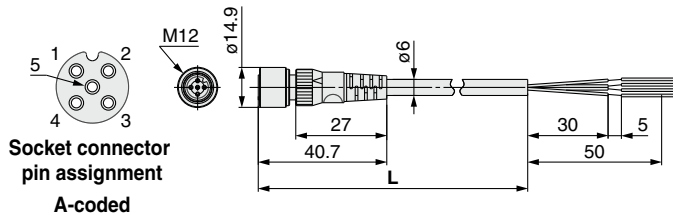

Item	Specifications
Cable O.D.	ø6 mm
Conductor nominal cross section	0.3 mm ² /AWG22
Wire O.D. (Including insulator)	1.5 mm
Min. bending radius (Fixed)	40 mm

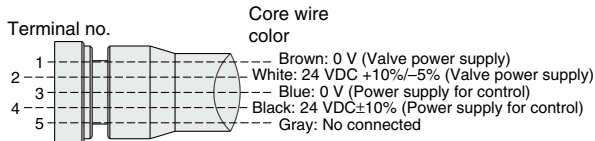

Connections (PROFIBUS DP)

Angle connector type

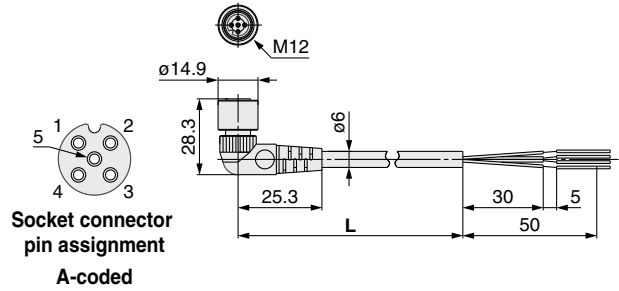

Item	Specifications
Cable O.D.	ø6 mm
Conductor nominal cross section	0.3 mm ² /AWG22
Wire O.D. (Including insulator)	1.5 mm
Min. bending radius (Fixed)	40 mm

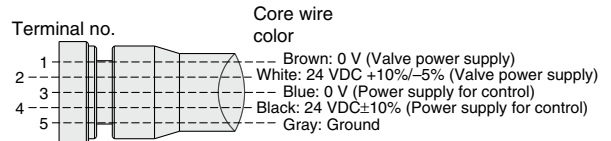

Connections (DeviceNet™)



Made to Order

Cable length	10000 mm	p. 91
--------------	----------	--------------

Type 1	EX260
Type 1	EX123/124/126
Type 2	EX500
Type 2	EX600
Type 3	EX245
Type 3	EX250
Type 1	EX120/121/122
Type 1	EX140
Type 1	EX180
Type 2	EX510
	M8/M12
	ATEX

EX500 Series

④ Branch Cable

Connects the GW unit and SI unit or input unit.

EX500-AC **030** - **SSPS**

● Connector specification

SSPS	Socket side: Straight, Plug side: Straight
SAPA	Socket side: Angle, Plug side: Angle

● Cable length (L)

003	300 mm
005	500 mm
010	1000 mm
030	3000 mm
050	5000 mm
100	10000 mm

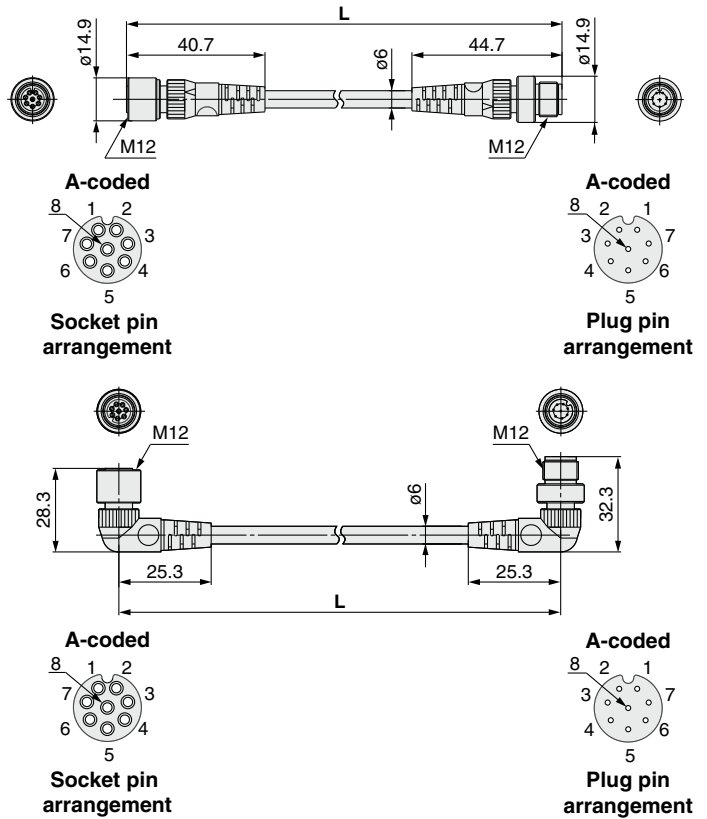

Item	Specifications
Cable O.D.	ø6 mm
Conductor nominal cross section	0.25 mm ²
Wire O.D. (Including insulator)	1.27 mm
Min. bending radius (Fixed)	40 mm

⑤ Terminal Plug

Use this where an input unit manifold is not being used. (If a terminal plug is not used, the GW unit's COM LED will not light up.)

EX500-AC000-S

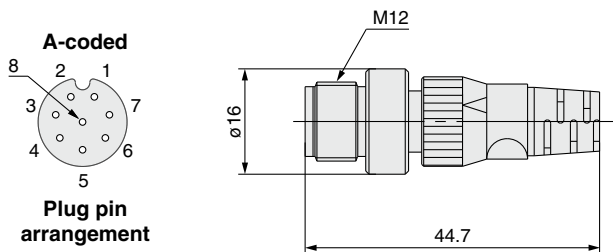

⑥ Seal Cap (1 pc.)

Use with new connector (plug). By using these seal caps, the new connector maintains IP65/67 enclosure.

EX500-AWTP

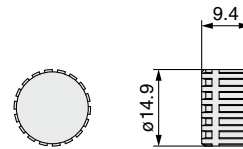

⑦ Seal Cap (10 pcs.)

Use with new connector. By using these seal caps, the new connector maintains IP65/67 enclosure.

EX9-AWES For M8 connector socket **EX9-AWTS** For M12 connector socket



● Refer to page 71 for details about output block and power block.

ATEX	M8/M12	Type 2		Type 1			Type 3		Type 2	Type 1	
		EX510	EX180	EX140	EX120/121/122	EX250	EX245	EX600	EX500	EX123/124/126	EX260

EX500 Series

Communication Cable

With connector on one side (Socket)

Cable length: 10000 mm

For DeviceNet™

EX9-AC100DN-X12

Dimensions

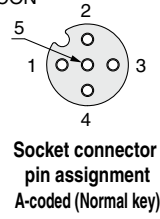
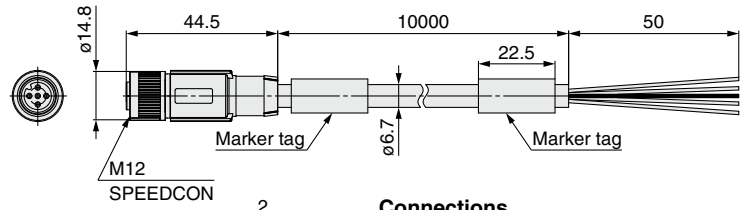

Connections

Terminal no.	Core wire colors: Signal name (DeviceNet™)
1	Shield: DRAIN
2	Red: V+
3	Black: V-
4	White: CAN H
5	Blue: CAN L

Item	Specifications	
Cable O.D.	ø6.7 mm	
Conductor nominal cross section	Power pair	0.34 mm ² /AWG22
	Data pair	0.25 mm ² /AWG24
Wire O.D. (Including insulator)	Power pair	1.4 mm
	Data pair	2.05 mm
Min. bending radius (Fixed)	67 mm	

ATEX	M8/M12	Type 2			Type 1			Type 3			Type 2	Type 1	
		EX510	EX180	EX140	EX120/121/122	EX250	EX245	EX600	EX500	EX123/124/126	EX260		

EX500 Series

Power Supply Cable

① With connector on one side (Socket)

Cable length: 10000 mm

For PROFIBUS DP

For DeviceNet™

EX500-AP100-**S**-X1

• Connector specification

S	Straight
A	Angle

Straight connector type

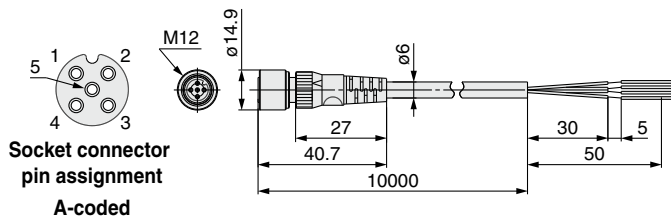

Item	Specifications
Cable O.D.	ø6 mm
Conductor nominal cross section	0.3 mm ² /AWG22
Wire O.D. (Including insulator)	1.5 mm
Min. bending radius (Fixed)	40 mm

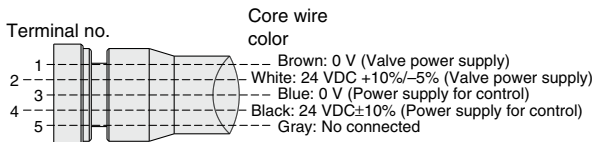

Connections (PROFIBUS DP)

Angle connector type

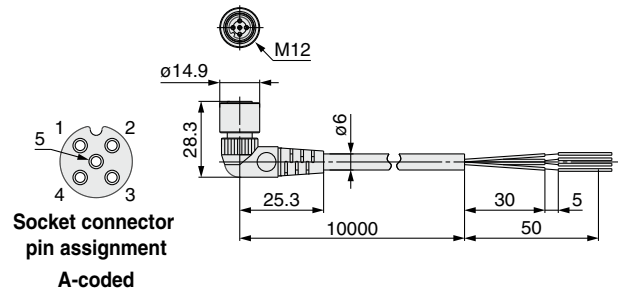

Item	Specifications
Cable O.D.	ø6 mm
Conductor nominal cross section	0.3 mm ² /AWG22
Wire O.D. (Including insulator)	1.5 mm
Min. bending radius (Fixed)	40 mm

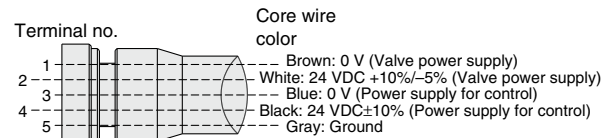

Connections (DeviceNet™)

② With connector on one side (Socket)

Cable length: 10000 mm

For Power block

Straight connector type

EX9-AC100-1-X16

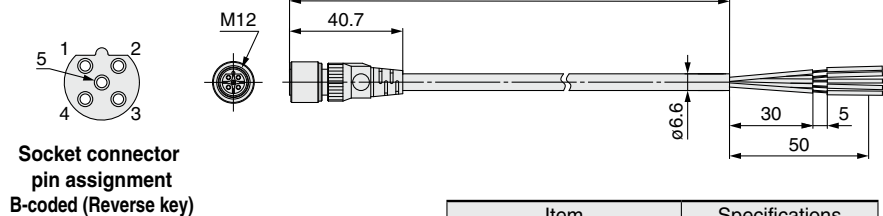

Item	Specifications
Cable O.D.	ø6.6 mm
Conductor nominal cross section	0.3 mm ² /AWG22
Wire O.D. (Including insulator)	1.65 mm
Min. bending radius (Fixed)	40 mm

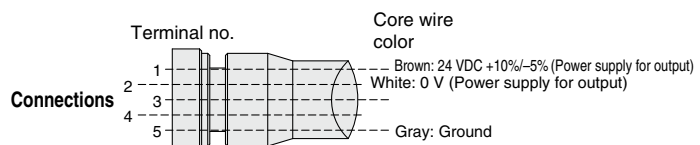

Connections



EX500 Series Specific Product Precautions

Be sure to read this before handling the products. Refer to page 277 for safety instructions. For fieldbus system precautions, refer to pages 278 to 280 and the "Operation Manual" on the SMC website: <http://www.smcworld.com>

Operating Environment

⚠ Caution

1. Select the proper type of enclosure according to the operating environment.

IP65/67 is achieved when the following conditions are met.

- 1) Provide appropriate wiring between the products using electrical wiring cables, communication connectors and cables with M12 connectors.
- 2) Suitable mounting of the product and valve manifold.
- 3) Be sure to mount a seal cap on any unused connectors.

If using in an environment that is exposed to water splashes, please take measures such as using a cover.

Adjustment / Operation

⚠ Warning

<Web server function>

1. The valve operation test is a function which forcibly changes the signal status. Please check safety of the ambient environment and the device before using this function.

This may cause injuries or equipment damage.

2. If the communication line and PC are shut down during a valve operation test, the valve output status will be held (It remains in the output status before the communication line and/or PC was shut down). Please check safety of the ambient environment and the device when performing this function.

This may cause injuries or equipment damage.

Type 1	EX260
Type 1	EX123/124/126
Type 2	EX500
Type 3	EX600
Type 3	EX245
Type 3	EX250
Type 1	EX120/121/122
Type 1	EX140
Type 1	EX180
Type 2	EX510
	M8/M12
	ATEX

■ Trademark

DeviceNet™ is a trademark of ODVA.
EtherNet/IP™ is a trademark of ODVA.
QuickConnect™ is a trademark of ODVA.