

Stainless Steel 316 Fittings

KQG2 Series

RoHS

Compact and Light

Dimensions **Approx. 30%** Shorter
* KQG2L06-01S

Weight **Approx. 62%** Lighter
* KQG2L06-01S

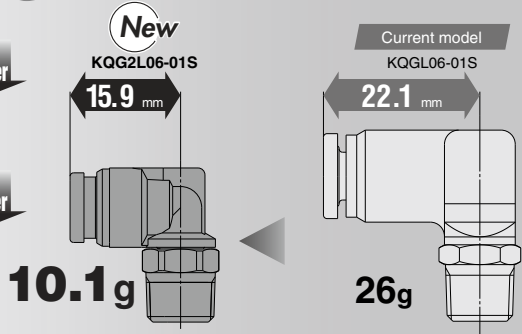

Material

Stainless steel 316

- Grease-free/Can be used with steam.
- Certified to meet current Food Sanitation Law standards.

(Component materials have met apparatuses and container-packages standards.)

Fluid temperature

-5 to 150°C

Applicable tubing

Metric size, Inch size

Connection thread

M, R, Rc, UNF, NPT

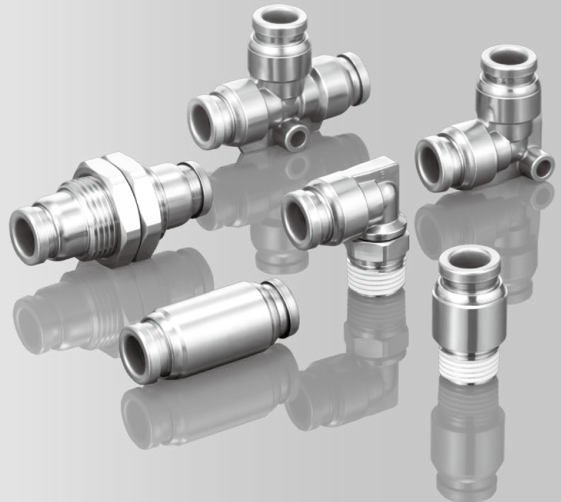

Stainless Steel 316 One-touch Fittings *KQG2 Series*

Compact and light

Dimensions: Approx. **30%** shorter

Weight: Approx. **62%** lighter

* Comparison with KQGL06-01S

Material

Metal parts: **Stainless steel 316**

Seal parts: **Special FKM**

Applicable tubing material

FEP • PFA • Nylon • Soft nylon

Polyurethane • Polyolefin

Fluid temperature: **-5 to 150°C**

Grease-free

Can be used with steam.

New

KQG2L06-01S

15.9 mm

Weight
10.1 g

Current model

KQGL06-01S

22.1 mm

Weight
26 g

All Stainless steel 316
except seal parts

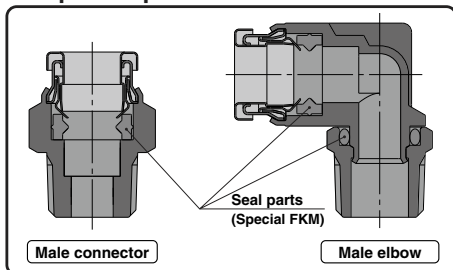

Applicable tubing	Connection thread	Page
Metric size	M, R, Rc	P.400 to 405
Inch size	UNF, NPT	P.406 to 411



Current model

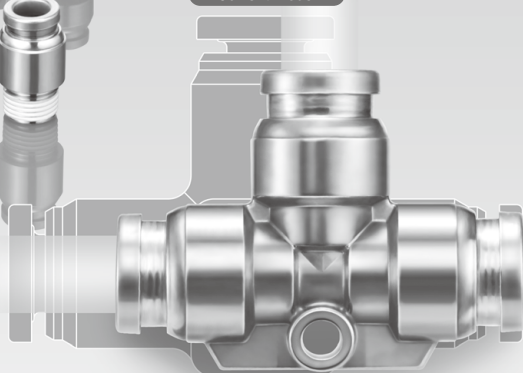

Certified to meet current
Food Sanitation Law standards.
(Component materials have
met apparatuses and container-
packages standards.)

Stainless Steel 316 One-touch Fittings *KQG2 Series*

Variations

Male Connector **KQG2H**



MetricP. 401
InchP. 407

Bulkhead Union **KQG2E**



MetricP. 403
InchP. 409

Different Diameter Union "Y" **KQG2U**



MetricP. 404
InchP. 410

Hexagon Socket Head Male Connector **KQG2S**



MetricP. 401
InchP. 407

Union Tee **KQG2T**



MetricP. 403
InchP. 409

Bulkhead Connector **KQG2E**



MetricP. 404
InchP. 410

Straight Union **KQG2H**



MetricP. 401
InchP. 407

Union "Y" **KQG2U**



MetricP. 403
InchP. 409

Extended Male Elbow **KQG2W**



MetricP. 405
InchP. 410

Male Elbow **KQG2L**



MetricP. 402
InchP. 408

Different Diameter Tee **KQG2T**



MetricP. 403
InchP. 409

Female Connector **KQG2F**



MetricP. 405
InchP. 411

Male Branch Tee **KQG2T**



MetricP. 402
InchP. 408

Plug-in Reducer **KQG2R**



MetricP. 403
InchP. 409

Plug **KQG2P**



MetricP. 405
InchP. 411

Union Elbow **KQG2L**



MetricP. 402
InchP. 408

Different Diameter Straight **KQG2H**



MetricP. 404
InchP. 410

Stainless Steel 316 One-touch Fittings

Applicable Tubing: Metric Size, Connection Thread: M, R, Rc

KQG2 Series

RoHS



Applicable Tubing

Tubing material	FEP, PFA, Nylon, Soft nylon, Polyurethane, Polyolefin
Tubing O.D.	ø3.2, ø4, ø6, ø8, ø10, ø12, ø16

Specifications

Fluid	Air, N ₂ , Water, Steam ^{Note 1)} ^{Note 2)}
Operating pressure range ^{Note 3)}	-100 kPa to 1 MPa ^{Note 4)}
Proof pressure	3.0 MPa
Ambient and fluid temperature ^{Note 5)}	-5 to 150°C (No freezing) ^{Note 4)}
Lubricant	Grease-free specification
Seal on the threads	With sealant

Note 1) Consult with SMC regarding applicable tube separately.

Note 2) Using special FKM that is resistant even when steam is used.

Note 3) Avoid using in a vacuum holding application such as a leak tester, since there is leakage.

Note 4) Check the operating pressure range and operating temperature range of the tubing.

Note 5) It is recommended that you use the inner sleeve in the following conditions (Except ø3.2):

- When using in an environment where the fluid temperature changes drastically.
- When using at a high temperature.

* Temperature Condition of Mounting the Inner Sleeve

Tubing	Temperature
FEP tubing/TH Series	80°C or more
Super PFA tubing/TL Series	120°C or more

Spare Parts

Description	Tubing O.D.	Part no.	Material
Gasket	—	M-5G3	Stainless steel 316, Special FKM
Bulkhead nut	ø3.2, ø4	KQG223-P01	Stainless steel 316
	ø6	KQG206-P01	
	ø8	KQG208-P01	
	ø10	KQG210-P01	
	ø12	KQG212-P01	
	ø16	KQG216-P01	

Cross Reference Table of the Inner Sleeve

Tubing O.D.	Tubing material			Applicable inner sleeve	
	TUS (Soft polyurethane)	TH/TH (FEP)	TL/TL (Super PFA)	Part no.	Length
ø4	—	TH0402	—	TJG-0402	18
	TUS0425	TH0425	—	TJG-0425	18
ø6	—	—	TL0403	TJG-0403	18
	TUS0604	TH0604	TL0604	TJG-0604	19
ø8	TUS0805	—	—	TJG-0805	20.5
	—	TH0806	TL0806	TJG-0806	20.5
ø10	TUS1065	—	—	TJG-1065	23
	—	TH1075	—	TJG-1075	23
ø12	—	TH1008	TL1008	TJG-1008	23
	TUS1208	—	—	TJG-1208	24
ø12	—	TH1209	—	TJG-1209	24
	—	TH1210	TL1210	TJG-1210	24

* Stainless steel 316 is used for the TJG series.

Construction

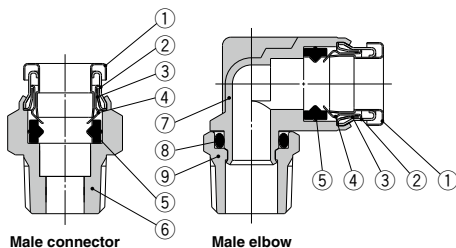

Component Parts

No.	Description	Material
1	Release button	Stainless steel 316
2	Guide 1	Stainless steel 316
3	Guide 2	Stainless steel 316
4	Chuck	Stainless steel 316
5	Seal	Special FKM (Fluoro coated)
6	Male connector body	Stainless steel 316
7	Male elbow body	Stainless steel 316
8	O-ring	Special FKM (Fluoro coated)
9	Stud	Stainless steel 316 (Fluoro coated)

Dimensions

Male Connector: KQG2H



Applicable tubing O.D. (mm)	Connection thread R, M	Model	H (Width across flat)	øD	L	A*	M	Note 1) Effective area (mm ²)	Weight (g)
ø3.2	M5 x 0.8	KQG2H23-M5	8	—	16.5	13.5	12	3	3.3
	1/8	KQG2H23-01S	10		15.4	12.3			
	1/4	KQG2H23-02S	14		21	16.3			
ø4	M5 x 0.8	KQG2H04-M5	10	—	17.1	14.1	12.6	4	5
	1/8	KQG2H04-01S	10		15.3	12.2			
	1/4	KQG2H04-02S	14		20.9	16.2			
ø6	M5 x 0.8	KQG2H06-M5	12	—	19.1	16.1	13.6	4	7.7
	1/8	KQG2H06-01S	12		18.1	15			
	1/4	KQG2H06-02S	14		20.8	16.1			
	3/8	KQG2H06-03S	17		23	17.9			
	1/8	KQG2H08-01S	14		24.5	21.4			
ø8	1/4	KQG2H08-02S	14	—	22.3	17.6	16.1	26.1	12.9
	3/8	KQG2H08-03S	17		23.7	18.6			
	1/8	KQG2H10-01S	17		25.5	22.4			
ø10	1/4	KQG2H10-02S	17	—	27.9	23.2	17	26.1	18.9
	3/8	KQG2H10-03S	17		23	17.9			
	1/2	KQG2H10-04S	22		28.6	22.2			
	1/4	KQG2H12-02S	19		30.5	25.8			
ø12	3/8	KQG2H12-03S	19	—	24.7	19.6	18.6	58.3	20.5
	1/2	KQG2H12-04S	22		28.7	22.3			
ø16	3/8	KQG2H16-03S	24	24.6	33.6	28.5	20.8	81	46
	1/2	KQG2H16-04S	24		29.5	23.1			

* Reference dimensions after installation for R thread
Note 1) Value of FEP tubing.
Value of nylon tubing for ø16 only.

(M5)

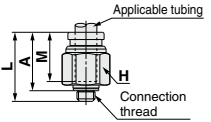

(R)

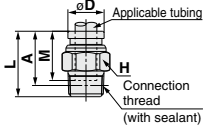

Hexagon Socket Head Male Connector: KQG2S



Applicable tubing O.D. (mm)	Connection thread R, M	Model	H (Width across flat)	Note 1) øD	L	A*	M	Note 2) Effective area (mm ²)	Weight (g)
ø3.2	M5 x 0.8	KQG2S23-M5	2	9	16.5	13.5	12	3	3.8
	1/8	KQG2S04-M5	2	9	17.1	14.1	12.6	4	3.7
ø4	M5 x 0.8	KQG2S04-01S	3	10	19.6	16.5	13.6	4.1	7.6
	1/8	KQG2S06-M5	2	12	19.6	16.6			
ø6	1/8	KQG2S06-01S	4	14	20.6	17.5	13.6	10.7	14
	1/4	KQG2S06-02S	4	14	20.6	15.9			
	1/8	KQG2S08-01S	5	14	24.7	21.6			
ø8	1/4	KQG2S08-02S	5	14	22.9	18.2	16.1	17.2	12.3
	3/8	KQG2S08-03S	6	17	23.1	18			
	1/8	KQG2S10-01S	5	17	25.6	22.5			
ø10	1/4	KQG2S10-02S	5	17	27.5	22.8	17	39	19.1
	3/8	KQG2S10-03S	8	22	24	18.9			
	1/2	KQG2S10-04S	8	22	24	17.6			
	1/4	KQG2S12-02S	8	19	30.6	25.9			
ø12	3/8	KQG2S12-03S	8	19	24.9	19.8	18.6	60	19.3
	1/2	KQG2S12-04S	10	22	24.9	18.5			
ø16	3/8	KQG2S16-03S	10	24.6	33.2	28.1	20.8	81	41.6
	1/2	KQG2S16-04S	12	24.6	29.4	23			

* Reference dimensions after installation for R thread
Note 1) For the ø16, this dimension refers to the O.D. of the release button.
Note 2) Value of FEP tubing.
Value of nylon tubing for ø16 only.

(M5)

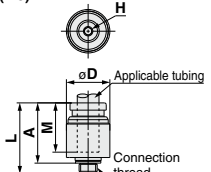

(R)

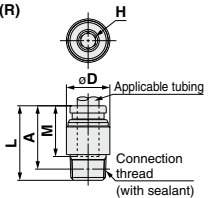

Straight Union: KQG2H



Applicable tubing O.D. (mm)	Model	øD Note 1)	L	M	Note 2) Effective area (mm ²)	Weight (g)
ø3.2	KQG2H23-00	9	25	12	3.4	6.5
ø4	KQG2H04-00	9	26.2	12.6	5.6	6.5
ø6	KQG2H06-00	12	28.2	13.6	13.1	11.5
ø8	KQG2H08-00	14	33.2	16.1	26.1	16.6
ø10	KQG2H10-00	17	35	17	41.5	26
ø12	KQG2H12-00	19	38.2	18.6	58.3	32.2
ø16	KQG2H16-00	24.6	42.6	20.8	113	53.7

Note 1) For the ø16, this dimension refers to the O.D. of the release button.
Note 2) Value of FEP tubing.
Value of nylon tubing for ø16 only.

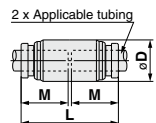

KQG2 Series

Applicable Tubing: Metric Size, Connection Thread: M, R, Rc

Dimensions

Male Elbow: KQG2L



Applicable tubing O.D. (mm)	Connection thread R, M	Model	H (With across flat)	Note 1) ϕ D	L1	L2	A*	M	Note 2) Effective area (mm ²)	Weight (g)
ϕ 3.2	M5 x 0.8	KQG2L23-M5	8	8.3	13.1	14.8	16	12	2.6	6.3
	1/8	KQG2L23-01S	10		13.6	14.9	15.9			
	1/4	KQG2L23-02S	14		13.7	15.2	16.8			
ϕ 4	M5 x 0.8	KQG2L04-M5	8	9.1	13.7	15.2	16.8	12.6	3.5	6.9
	1/8	KQG2L04-01S	10		14.4	15.3	16.7			
	1/4	KQG2L04-02S	14		14.7	16.3	19			
ϕ 6	M5 x 0.8	KQG2L06-M5	8	11.4	14.7	16.3	19	13.6	11.4	10.1
	1/8	KQG2L06-01S	10		15.9	20.2	21.2			
	1/4	KQG2L06-02S	14		21.6	22.2	22.2			
ϕ 8	3/8	KQG2L06-03S	17	13.7	18.6	18.3	22	16.1	21.6	14.6
	1/4	KQG2L08-01S	12		19.1	21.5	23.6			
	3/8	KQG2L08-03S	17		22.9	24.6	24.6			
ϕ 10	1/8	KQG2L10-01S	12	16.6	20	19.7	24.9	17	21.6	20.2
	1/4	KQG2L10-02S	14		22.9	26.5	26.5			
	3/8	KQG2L10-03S	17		24.3	27.5	27.5			
ϕ 12	1/2	KQG2L10-04S	22	18.7	28.5	30.4	30.4	18.6	50.2	33.7
	1/4	KQG2L12-02S	14		22.6	24	28.6			
	3/8	KQG2L12-03S	17		23.6	25.3	29.5			
ϕ 16	1/2	KQG2L12-04S	22	24.6	29.5	32.4	32.4	20.8	71	46.3
	3/8	KQG2L16-03S	19		26.3	28	34.5			
	1/2	KQG2L16-04S	22		27.3	31.8	37			

* Reference dimensions after installation for R thread
 Note 1) For the ϕ 16, this dimension refers to the O.D. of the release button.
 Note 2) Value of FEP tubing.
 Value of nylon tubing for ϕ 16 only.

(M5)

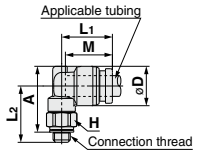

(R)

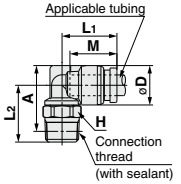

Male Branch Tee: KQG2T



Applicable tubing O.D. (mm)	Connection thread R, M	Model	H (With across flat)	Note 1) ϕ D	L1	L2	A*	M	Note 2) Effective area (mm ²)	Weight (g)
ϕ 3.2	M5 x 0.8	KQG2T23-M5	8	8.3	13.1	14.8	16	12	3.2	8.1
	1/8	KQG2T23-01S	10		13.6	14.9	15.9			
	1/4	KQG2T23-02S	14		13.7	15.2	16.8			
ϕ 4	M5 x 0.8	KQG2T04-M5	8	9.1	13.7	15.2	16.8	12.6	4.5	9
	1/8	KQG2T04-01S	10		14.4	15.3	16.7			
	1/4	KQG2T04-02S	14		14.7	16.3	19			
ϕ 6	M5 x 0.8	KQG2T06-M5	8	11.4	14.7	16.3	19	13.6	13.9	13.4
	1/8	KQG2T06-01S	10		15.9	20.2	21.2			
	1/4	KQG2T06-02S	14		21.6	22.2	22.2			
ϕ 8	3/8	KQG2T06-03S	17	13.7	18.6	18.3	22	16.1	26.3	20
	1/4	KQG2T08-01S	12		19.1	21.5	23.6			
	3/8	KQG2T08-03S	17		22.9	24.6	24.6			
ϕ 10	1/8	KQG2T10-01S	12	16.6	20	19.7	24.9	17	21.6	28.4
	1/4	KQG2T10-02S	14		22.9	26.5	26.5			
	3/8	KQG2T10-03S	17		24.3	27.5	27.5			
ϕ 12	1/2	KQG2T10-04S	22	18.7	28.5	30.4	30.4	18.6	40.8	31.1
	1/4	KQG2T12-02S	14		22.6	24	28.6			
	3/8	KQG2T12-03S	17		23.6	25.3	29.5			
ϕ 16	1/2	KQG2T12-04S	22	24.6	29.5	32.4	32.4	20.8	71	63.7
	3/8	KQG2T16-03S	19		26.3	28	34.5			
	1/2	KQG2T16-04S	22		27.3	31.8	37			

* Reference dimensions after installation for R thread
 Note 1) For the ϕ 16, this dimension refers to the O.D. of the release button.
 Note 2) Value of FEP tubing.
 Value of nylon tubing for ϕ 16 only.

(M5)

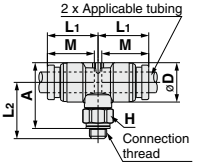

(R)

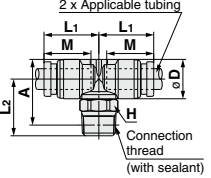

Union Elbow: KQG2L



Applicable tubing O.D. (mm)	Model	Note 1) ϕ D	L	A	Q	M	ϕ N	ϕ O	Note 2) Effective area (mm ²)	Weight (g)
ϕ 3.2	KQG2L23-00	8.3	13.6	19.3	2.9	12	3.2	5.6	3	6.3
ϕ 4	KQG2L04-00	9.1	14.6	20.5	3.1	12.6	3.2	5.6	4.2	7.4
ϕ 6	KQG2L06-00	11.4	16.6	23	3.6	13.6	3.2	5.6	11.4	11
ϕ 8	KQG2L08-00	13.7	20.1	29.1	5	16.1	4.2	8	21.6	20.2
ϕ 10	KQG2L10-00	16.6	22	31.7	5.7	17	4.2	8	35.2	29.6
ϕ 12	KQG2L12-00	18.7	24.6	35	6.4	18.6	4.2	8	50.2	37.1
ϕ 16	KQG2L16-00	24.6	28.8	40.5	7.7	20.8	4.2	8	100	59.7

Note 1) For the ϕ 16, this dimension refers to the O.D. of the release button.
 Note 2) Value of FEP tubing.
 Value of nylon tubing for ϕ 16 only.

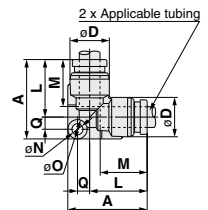

Stainless Steel 316 One-touch Fittings **KQG2 Series**

Applicable Tubing: Metric Size, Connection Thread: M, R, Rc

Dimensions

Bulkhead Union: KQG2E



Applicable tubing O.D. (mm)	Model	T (M)	H (Width across flat)	L	Mounting hole	M	Note 2) Effective area (mm ²)	Weight (g)
ø3.2	KQG2E23-00	M10 x 1	12	32.2	11	12	3.4	14
ø4	KQG2E04-00	M10 x 1	12	32.4	11	12.6	5.6	14
ø6	KQG2E06-00	M14 x 1	17	33.6	15	13.6	13.1	25.8
ø8	KQG2E08-00	M15 x 1	19	36.4	16	16.1	26.1	30.4
ø10	KQG2E10-00	M18 x 1	21	37.2	19	17	41.5	40.3
ø12	KQG2E12-00	M20 x 1	24	39.2	21	18.6	58.3	49.9
ø16	KQG2E16-00	M27 x 1	30	42.6	28	20.8	113	87.3

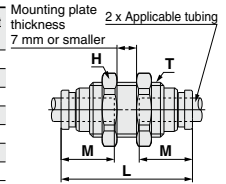

Note) Value of FEP tubing.
Value of nylon tubing for ø16 only.

Union Tee: KQG2T



Applicable tubing O.D. (mm)	Model	Note 1) øD	L	A	Q	M	øN	øO	Note 2) Effective area (mm ²)	Weight (g)
ø3.2	KQG2T23-00	8.3	13.6	20.5	4.1	12	3.2	5.6	3.4	7.9
ø4	KQG2T04-00	9.1	14.6	21.8	4.4	12.6	3.2	5.6	6.4	9.5
ø6	KQG2T06-00	11.4	16.6	24.6	5.2	13.6	3.2	5.6	13.4	14.2
ø8	KQG2T08-00	13.7	20.1	31.1	7	16.1	4.2	8	25.6	24.4
ø10	KQG2T10-00	16.6	22	34	8	17	4.2	8	40	36.8
ø12	KQG2T12-00	18.7	24.6	37.7	9.1	18.6	4.2	8	57.4	46.9
ø16	KQG2T16-00	24.6	28.8	43.4	10.6	20.8	4.2	8	100	75.5

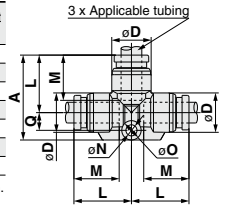

Note 1) For the ø16, this dimension refers to the O.D. of the release button.
Note 2) Value of FEP tubing.
Value of nylon tubing for ø16 only.

Union "Y": KQG2U



Applicable tubing O.D. (mm)	Model	Note 1) øD	W	L1	L2	P	M	øN	øO	Note 2) Effective area (mm ²)	Weight (g)
ø3.2	KQG2U23-00	8.3	16.4	29	11	8.1	12	3.2	5.6	3.4	9.2
ø4	KQG2U04-00	9.1	18.2	30.4	11.3	9.1	12.6	3.2	5.6	4.2	11.1
ø6	KQG2U06-00	11.4	22.9	34.9	12.2	11.5	13.6	3.2	5.6	13.4	18.8
ø8	KQG2U08-00	13.7	28.3	40.1	14.1	14.6	16.1	4.2	8	25.6	29.7
ø10	KQG2U10-00	16.6	34.2	44	14.4	17.6	17	4.2	8	40	47.4
ø12	KQG2U12-00	18.7	38.5	48.4	15.8	19.8	18.6	4.2	8	57.4	62.1
ø16	KQG2U16-00	24.6	49.3	56.6	17.3	26	20.8	4.2	8	113	110.2

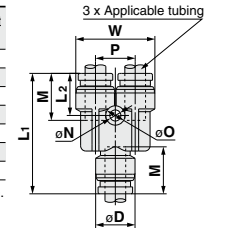

Note 1) For the ø16, this dimension refers to the O.D. of the release button.
Note 2) Value of FEP tubing.
Value of nylon tubing for ø16 only.

Different Diameter Tee: KQG2T



Applicable tubing O.D. (mm)	Model	Note 1) øD1	Note 1) øD2	L1	L2	L3	Q	M1	M2	øN	øO	Note 2) Effective area (mm ²)	Weight (g)
ø3.2 ø4	KQG2T23-04	9.1	8.3	14.2	14.1	21.1	4.1	12.6	12	3.2	5.6	3.8	8.5
ø4 ø6	KQG2T04-06	11.4	9.1	15.6	15.7	22.8	4.4	13.6	12.6	3.2	5.6	7.1	11.5
ø6 ø8	KQG2T06-08	13.7	11.4	19.1	17.7	29.5	6.4	16.1	13.6	4.2	8	16.4	20
ø8 ø10	KQG2T08-10	16.6	13.7	21	21.2	32.1	7.1	17	16.1	4.2	8	36	29.8
ø10 ø12	KQG2T10-12	18.7	16.6	23.6	23.1	35.7	8.1	18.6	17	4.2	8	56	41.3
ø12 ø16	KQG2T12-16	24.6	18.7	26.8	26.7	39.9	9.1	20.8	18.6	4.2	8	108.5	58

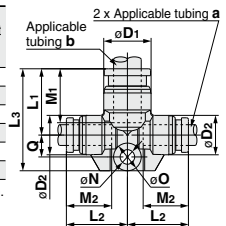

Note 1) For the ø16, this dimension refers to the O.D. of the release button.
Note 2) Value of FEP tubing.

Plug-in Reducer: KQG2R



Applicable tubing O.D. (mm)	Applicable fitting size ød	Model	øD	L	A	M	Note) Effective area (mm ²)	Weight (g)
ø3.2	ø4	KQG2R23-04	9	32.9	20.3	12	3.4	4.7
ø4	ø6	KQG2R04-06	9	34.4	20.8	12.6	5.6	6.7
ø6	ø8	KQG2R06-08	12	38.4	22.3	13.6	13.1	12.1
ø8	ø10	KQG2R08-10	14	41.9	24.9	16.1	26.1	18.3
ø10	ø12	KQG2R10-12	17	44.8	26.2	17	41.5	26.5
ø12	ø16	KQG2R12-16	19	42.9	22.1	18.6	58.3	35.4

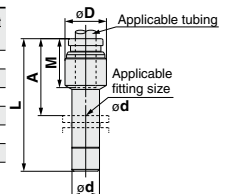

Note) Value of FEP tubing.

KQG2 Series

Applicable Tubing: Metric Size, Connection Thread: M, R, Rc

Dimensions

Different Diameter Straight: KQG2H



Applicable tubing O.D. (mm)		Model	Note 1) ϕD	L	M ₁	M ₂	Note 2) Effective area (mm ²)	Weight (g)
a	b							
$\phi 3.2$	$\phi 4$	KQG2H23-04	9	25.6	12	12.6	3.4	6.5
$\phi 4$	$\phi 6$	KQG2H04-06	12	27.2	12.6	13.6	5.6	11.6
$\phi 6$	$\phi 8$	KQG2H06-08	14	30.7	13.6	16.1	13.1	16.3
$\phi 8$	$\phi 10$	KQG2H08-10	17	34.1	16.1	17	26.1	26
$\phi 10$	$\phi 12$	KQG2H10-12	19	36.6	17	18.6	41.5	33.3
$\phi 12$	$\phi 16$	KQG2H12-16	24.6	40.4	18.6	20.8	58.3	54.7

Note 1) For the $\phi 16$, this dimension refers to the O.D. of the release button.
Note 2) Value of FEP tubing.

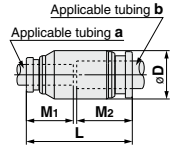

Different Diameter Union "Y": KQG2U



Applicable tubing O.D. (mm)		Model	Note 1) ϕD	L ₁	L ₂	P	W	M ₁	M ₂	ϕN	ϕO	Note 2) Effective area (mm ²)	Weight (g)
a	b												
$\phi 3.2$	$\phi 4$	KQG2U23-04	9.1	27	10.8	8.1	16.4	12	12.6	3.2	5.6	3.2	8.5
$\phi 4$	$\phi 6$	KQG2U04-06	11.4	29.3	11.2	9.1	18.2	12.6	13.6	3.2	5.6	4.2	11.9
$\phi 6$	$\phi 8$	KQG2U06-08	13.7	33.7	12.2	11.5	22.9	13.6	16.1	4.2	8	13.4	19.3
$\phi 8$	$\phi 10$	KQG2U08-10	16.6	38.3	13.8	14.6	28.3	16.1	17	4.2	8	25.6	31.6
$\phi 10$	$\phi 12$	KQG2U10-12	18.7	43	14	17.6	34.2	17	18.6	4.2	8	40	47.6
$\phi 12$	$\phi 16$	KQG2U12-16	24.6	47.4	15.6	19.8	38.5	18.6	20.8	4.2	8	57.4	67.6

Note 1) For the $\phi 16$, this dimension refers to the O.D. of the release button.
Note 2) Value of FEP tubing.

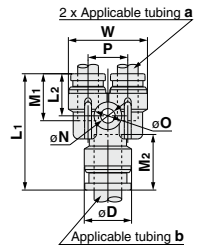

Bulkhead Connector: KQG2E



Applicable tubing O.D. (mm)	Connection thread Rc	Model	T (M)	Width across flat		L ₁	L ₂	Mounting hole	M	Note 2) Effective area (mm ²)	Weight (g)
				H ₁	H ₂						
$\phi 3.2$	1/4	KQG2E23-02	M10 x 1	17	12	31	14.8	11	12	3.4	26.1
				14	12	25.8	9.7	16			
$\phi 4$	1/4	KQG2E04-01	M10 x 1	17	12	30.9	14.8	11	12.6	5.6	25.6
				17	17	24.2	7	24.4			
$\phi 6$	1/4	KQG2E06-01	M14 x 1	17	17	30.9	13.7	15	13.6	13.1	30.9
				19	19	32.1	14.9	32			
$\phi 8$	1/4	KQG2E08-01	M15 x 1	17	19	26.3	8.1	16	16.1	26.1	28
				19	19	31.3	13.1	31.2			
$\phi 10$	1/4	KQG2E08-02	M18 x 1	19	21	31.6	13	19	17	41.5	42.8
				24	24	33	14.4	37.5			
$\phi 12$	3/8	KQG2E12-03	M20 x 1	21	24	34	14.4	21	18.6	58.3	50.3
				24	24	39.3	19.7	60.7			
$\phi 16$	3/8	KQG2E16-03	M27 x 1	29	30	35.3	13.3	28	20.8	96	107.8
				30	30	40.6	18.6	113	114.6		

Note) Value of FEP tubing.
Value of nylon tubing for $\phi 16$ only.

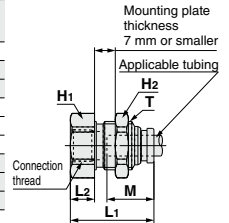

Dimensions

Extended Male Elbow: KQG2W



Applicable tubing O.D. (mm)	Connection thread R, M	Model	H (Width across flat)	Note 1) ϕD	L1	L2	A*	M	Note 2) Effective area (mm ²)	Weight (g)
$\phi 3.2$	M5 x 0.8	KQG2W23-M5	8	8.3	13.1	31.2	32.4	12	2.8	13
	1/8	KQG2W23-01S	10		13.6	31.3	32.3			14.7
	1/4	KQG2W23-02S	14			35.1	34.5			33.1
$\phi 4$	M5 x 0.8	KQG2W04-M5	8	9.1	13.7	31.6	33.2	12.6	3	13.6
	1/8	KQG2W04-01S	10		14.4	31.7	33.1			15.6
	1/4	KQG2W04-02S	14			35.5	35.3			33.9
$\phi 6$	M5 x 0.8	KQG2W06-M5	8	11.4	14.7	32.7	35.4	13.6	3	15.5
	1/8	KQG2W06-01S	10			32.8				17.2
	1/4	KQG2W06-02S	14		15.9	36.6	37.6			35.5
$\phi 8$	1/8	KQG2W08-01S	17	13.7	38	38.6		16.1	20.5	57.4
	1/4	KQG2W08-02S	12		18.6	37	40.7			28
	3/8	KQG2W08-03S	17		19.1	41.6	43.3			60.9
$\phi 10$	1/4	KQG2W10-02S	14	16.6	21	46.6	50.2	17	33.5	40.7
	3/8	KQG2W10-03S	17		22.6	47.7	52.3			61.9
	1/2	KQG2W10-04S	22			50.1	52			117.3
$\phi 12$	1/4	KQG2W12-02S	14	18.7	22.6	47.7	52.3	18.6	47.7	44.6
	3/8	KQG2W12-03S	17		23.6	49	53.2			56.3
	1/2	KQG2W12-04S	22			53.2	56.1			112.9
$\phi 16$	3/8	KQG2W16-03S	19	24.6	26.3	57.6	64.1	20.8	71	86.6
	1/2	KQG2W16-04S	22		27.3	61.4	66.6			100

* Reference dimensions after installation for R thread

Note 1) For the $\phi 16$, this dimension refers to the O.D. of the release button.

Note 2) Value of FEP tubing.

Value of nylon tubing for $\phi 16$ only.

(M5)

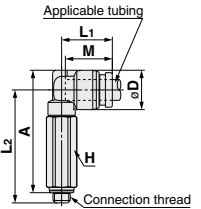

(R)

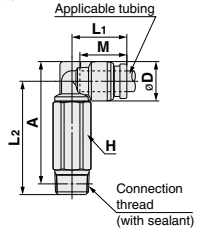

Female Connector: KQG2F



Applicable tubing O.D. (mm)	Connection thread Rc	Model	H (Width across flat)	Note 1) ϕD	L1	L2	M	Note 2) Effective area (mm ²)	Weight (g)
$\phi 3.2$	1/8	KQG2F23-01	12	8.7	23.3	9.8	12	3.4	8.9
	1/8	KQG2F04-01	12		23.7	9.8		9.2	
$\phi 4$	1/4	KQG2F04-02	17	11.1	28.7	13.2	12.6	5.6	21.6
	1/8	KQG2F06-01	12		24.2	10		10.5	
$\phi 6$	1/4	KQG2F06-02	17	13.4	29.2	13.4	13.6	13.1	23.1
	3/8	KQG2F06-03	19		30.6	14.2		24.5	
	1/8	KQG2F08-01	14		26.3	9.6		16.3	
$\phi 8$	1/4	KQG2F08-02	17	16.4	31.3	13.7	16.1	26.1	25.5
	3/8	KQG2F08-03	19		32.7	14.4		27	
	1/4	KQG2F10-02	17		31.6	13.9	17	41.5	28.8
$\phi 10$	3/8	KQG2F10-03	19	18.5	33	14.7	18.6	58.3	30.4
	1/4	KQG2F12-02	19		32.6	13.3			37.5
	3/8	KQG2F12-03	19		34	14.7			32.3
$\phi 12$	1/2	KQG2F12-04	24	24.6	39.3	18.4	20.8	81	50.2
	3/8	KQG2F16-03	24		35.3	13.5			59.7
$\phi 16$	1/2	KQG2F16-04	24		40.6	18.8		113	57

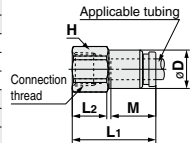

Note 1) For the $\phi 10$, $\phi 12$, and $\phi 16$, this dimension refers to the O.D. of the release button.

Note 2) Value of FEP tubing.

Value of nylon tubing for $\phi 16$ only.

Plug: KQG2P



Applicable fitting size ϕd	Model	ϕD	L	A	Weight (g)
$\phi 3.2$	KQG2P-23	5	28.9	16.9	2.7
$\phi 4$	KQG2P-04	6	29.6	17	4.1
$\phi 6$	KQG2P-06	8	30.8	17.2	8.5
$\phi 8$	KQG2P-08	10	33.7	17.6	15.5
$\phi 10$	KQG2P-10	12	34.6	17.6	24.1
$\phi 12$	KQG2P-12	14	36.5	17.9	35.8
$\phi 16$	KQG2P-16	18	38.6	17.8	65.5

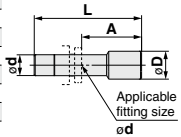

Related Equipment



Spatter cover

(Applicable tubing: FR soft nylon, FR double layer, FR three-layer)

Applicable tubing O.D. (mm)	Model
$\phi 6$	KQB2-06C-X1124
$\phi 8$	KQB2-08C-X1124
$\phi 10$	KQB2-10C-X1124

* Since the spatter cover is designed for multi-layer (double layer, three-layer) tubing, sufficient effects cannot be obtained in foreign matter flow-in or followability for singlayer tubing.

* The cover can be attached regardless of the single-layer/multi-layer tubing.

* Cannot be used for union "Y" (KQG2U) 2-port side.

Stainless Steel 316 One-touch Fittings

Applicable Tubing: Inch Size, Connection Thread: UNF, NPT

KQG2 Series

RoHS



Applicable Tubing

Tubing material	FEP, PFA, Nylon, Soft nylon, Polyurethane, Polyolefin
Tubing O.D.	ø1/8", ø5/32", ø1/4", ø5/16", ø3/8", ø1/2"

Specifications

Fluid	Air, N ₂ , Water, Steam ^{Note 1)} ^{Note 2)}
Operating pressure range ^{Note 3)}	-100 kPa to 1 MPa ^{Note 4)}
Proof pressure	3.0 MPa
Ambient and fluid temperature ^{Note 5)}	-5 to 150°C (No freezing) ^{Note 4)}
Lubricant	Grease-free specification
Seal on the threads	With sealant

Note 1) Consult with SMC regarding applicable tubing separately.

Note 2) Using special FKM that is resistant even when steam is used.

Note 3) Avoid using in a vacuum holding application such as a leak tester, since there is leakage.

Note 4) Check the operating pressure range and operating temperature range of the tubing.

Note 5) It is recommended that you use the inner sleeve in the following conditions (Except ø1/8"):

- When using in an environment where the fluid temperature changes drastically.
- When using at a high temperature.

* Temperature Condition of Mounting the Inner Sleeve

Tubing	Temperature
FEP tubing/TH Series	80°C or more
Super PFA tubing/TL Series	120°C or more

Spare Parts

Description	Tubing O.D.	Part no.	Material
Gasket	—	M-5G3	Stainless steel 316, Special FKM
Bulkhead nut	ø1/8", ø5/32"	KQG201-P01	Stainless steel 316
	ø1/4"	KQG207-P01	
	ø5/16"	KQG209-P01	
	ø3/8"	KQG211-P01	
	ø1/2"	KQG213-P01	

Cross Reference Table of the Inner Sleeve

Tubing O.D.	Tubing material		Applicable inner sleeve	
	TH/THI (FEP)	TL/TIL (Super PFA)	Part no.	Length
ø5/32"	TH0402	—	TJG-0402	18
	TH0425	—	TJG-0425	18
	—	TL0403	TJG-0403	18
ø1/4"	TIHB07	TIL07	TJG-0604	19
	TIHA07	—	TJG-0746	19
ø5/16"	TH0806	TL0806	TJG-0806	20.5
ø3/8"	TIHB11	TIL11	TJG-1065	23
	TIHA11	—	TJG-1107	23
ø1/2"	TIH13	TIL13	TJG-1395	24

* Stainless steel 316 is used for the TJG series.

Construction

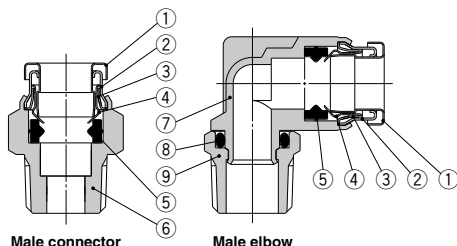

Component Parts

No.	Description	Material
1	Release button	Stainless steel 316
2	Guide 1	Stainless steel 316
3	Guide 2	Stainless steel 316
4	Chuck	Stainless steel 316
5	Seal	Special FKM (Fluoro coated)
6	Male connector body	Stainless steel 316
7	Male elbow body	Stainless steel 316
8	O-ring	Special FKM (Fluoro coated)
9	Stud	Stainless steel 316 (Fluoro coated)

Stainless Steel 316 One-touch Fittings **KQG2 Series**

Applicable Tubing: Inch Size, Connection Thread: UNF, NPT

Dimensions

Male Connector: KQG2H



Applicable tubing O.D. (inch)	Connection thread UNF, NPT	Model	H (Width across flat)	L	A*	M	Note) Effective area (mm ²)	Weight (g)
ø1/8"	10-32UNF	KQG2H01-32	8	16.5	13.5	12	3	3.3
	1/8	KQG2H01-N01S	12	17.1	13.9		3.4	8.1
	1/4	KQG2H01-N02S	14	20.9	16.5			16.9
ø5/32"	10-32UNF	KQG2H03-32	10	17.1	14.1	12.6	4	5
	1/8	KQG2H03-N01S	12	17	13.8		5.6	7.6
	1/4	KQG2H03-N02S	14	20.9	16.5			16.4
ø1/4"	10-32UNF	KQG2H07-32	12	19	16	13.5	4	7.5
	1/8	KQG2H07-N01S	12	20	16.8			8.6
	1/4	KQG2H07-N02S	14	20.6	16.2		13.1	14.2
	3/8	KQG2H07-N03S	19	23.8	19.1			31.4
ø5/16"	1/8	KQG2H09-N01S	14	24.2	21	16.1	26.1	12.6
	1/4	KQG2H09-N02S	14	23.1	18.7		26.1	13.9
	3/8	KQG2H09-N03S	19	24.6	19.9			28.9
ø3/8"	1/8	KQG2H11-N01S	17	25	21.8	16.6	26.1	19.4
	1/4	KQG2H11-N02S	17	26.3	21.9			20.3
	3/8	KQG2H11-N03S	19	23.6	18.9		41.5	25.2
	1/2	KQG2H11-N04S	22	28.3	21.9			51.8
	1/4	KQG2H13-N02S	22	30.5	26.1			36.7
ø1/2"	3/8	KQG2H13-N03S	22	28.4	23.7	18.5	58.3	34.4
	1/2	KQG2H13-N04S	22		22			43.4

* Reference dimensions after installation for NPT thread
Note) Value of FEP tubing.

(10-32UNF)

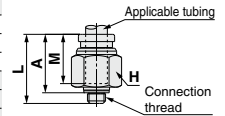

(NPT)

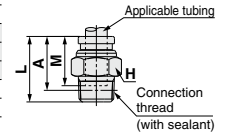

Hexagon Socket Head Male Connector: KQG2S



Applicable tubing O.D. (inch)	Connection thread UNF, NPT	Model	H (Width across flat)	øD	L	A*	M	Note) Effective area (mm ²)	Weight (g)
ø1/8"	10-32UNF	KQG2S01-32	2	9	16.5	13.5	12	3	3.8
		KQG2S03-32	2	9	17.1	14.1		4	3.7
ø5/32"	10-32UNF	KQG2S03-N01S	2.78	11	19.6	16.4	12.6	4.1	8.5
		KQG2S07-32	2	12	19.5	16.5		4	7.2
ø1/4"	1/8	KQG2S07-N01S	4.76	12	17.3	13.5	13.5	10	8.1
	1/4	KQG2S07-N02S	4.76	14	20.5	16.1		10.7	13.4
	3/8	KQG2S07-N03S	4.76	18	15.8	15.8			22.6
	1/8	KQG2S09-N01S	5.56	14	24.7	21.5		17.2	12
ø5/16"	1/4	KQG2S09-N02S	6.35	14	23.1	18.7	16.1	23.3	12.8
	3/8	KQG2S09-N03S	6.35	18	18.4	18.4			23.5
	1/8	KQG2S11-N01S	5.56	17	25.2	22		17.2	17.8
ø3/8"	1/4	KQG2S11-N02S	5.56	17	27.1	22.7	16.6		21.2
	3/8	KQG2S11-N03S	6.35	18	23.6	18.9		39	23.8
	1/2	KQG2S11-N04S	6.35	22	23.6	17.2			38.6
	1/4	KQG2S13-N02S	8	20	30.5	26.1		46	26.6
ø1/2"	3/8	KQG2S13-N03S	9.53	20	29.4	24.7	18.5	60	29
	1/2	KQG2S13-N04S	9.53	22	25.5	19.1			34.8

* Reference dimensions after installation for NPT thread
Note) Value of FEP tubing.

(10-32UNF)

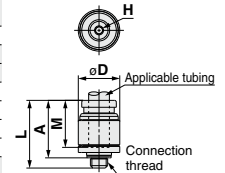

(NPT)

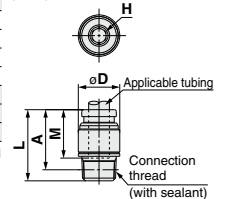

Straight Union: KQG2H



Applicable tubing O.D. (inch)	Model	øD	L	M	Note) Effective area (mm ²)	Weight (g)
ø1/8"	KQG2H01-00	9	25	12	3.4	6.5
ø5/32"	KQG2H03-00	9	26.2	12.6	5.6	6.5
ø1/4"	KQG2H07-00	12	28	13.5	13.1	11
ø5/16"	KQG2H09-00	14	33.2	16.1	26.1	16.6
ø3/8"	KQG2H11-00	16	34.2	16.6	41.5	22.7
ø1/2"	KQG2H13-00	20	38	18.5	58.3	35.5

Note) Value of FEP tubing.

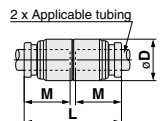

KQG2 Series

Applicable Tubing: Inch Size, Connection Thread: UNF, NPT

Dimensions

Male Elbow: KQG2L



Applicable tubing O.D. (inch)	Connection thread UNF, NPT	Model	H (Width across flat)	øD	L1	L2	A*	M	Note) Effective area (mm ²)	Weight (g)		
ø1/8"	10-32UNF	KQG2L01-32	8	8.3	13.1	14.8	16	12	2.6	6.3		
	1/8	KQG2L01-N01S	12		13.6	14.9	15.8				9	
	1/4	KQG2L01-N02S	14		13.7	15.2	16.8				3	16.7
ø5/32"	10-32UNF	KQG2L03-32	8	9.1	13.7	15.2	16.8	12.6	3.5	6.9		
	1/8	KQG2L03-N01S	12		14.4	15.3	16.6				4.2	9.9
	1/4	KQG2L03-N02S	14		14.7	16.5	19.3				3.5	17.6
ø1/4"	10-32UNF	KQG2L07-32	8	11.7	14.7	16.5	19.3	13.5	11.4	11.7		
	1/8	KQG2L07-N01S	12		15.9	20.4	21.8				19.4	
	1/4	KQG2L07-N02S	14		22.2	23.3	34.2					
ø5/16"	10-32UNF	KQG2L09-N01S	8	13.7	18.6	18.3	21.9	16.1	21.6	21.1		
	1/4	KQG2L09-N02S	14		19.1	21.5	23.9				21.6	21.1
	3/8	KQG2L09-N03S	19		23.3	25.4	35.7					
ø3/8"	10-32UNF	KQG2L11-N01S	12	16	20	19.4	24.2	16.6	21.6	19.7		
	1/4	KQG2L11-N02S	14		21	22.6	26.2				23.2	
	3/8	KQG2L11-N03S	19		24.4	27.7	36.7					
ø1/2"	10-32UNF	KQG2L13-N01S	14	19.6	22.7	24.4	29.8	18.5	50.2	29.4		
	3/8	KQG2L13-N03S	19		23.7	26.1	31.2				39.2	
	1/2	KQG2L13-N04S	22		29.9	33.3	61.3					

* Reference dimensions after installation for NPT thread
Note) Value of FEP tubing.

(10-32UNF)

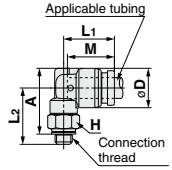

(NPT)

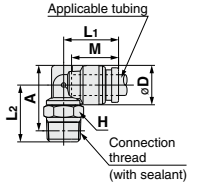

Male Branch Tee: KQG2T



Applicable tubing O.D. (inch)	Connection thread UNF, NPT	Model	H (Width across flat)	øD	L1	L2	A*	M	Note) Effective area (mm ²)	Weight (g)		
ø1/8"	10-32UNF	KQG2T01-32	8	8.3	13.1	14.8	16	12	3.2	8.1		
	1/8	KQG2T01-N01S	12		13.6	14.9	15.8				3.4	10.8
	1/4	KQG2T01-N02S	14		13.7	15.2	16.8				3.4	18.5
ø5/32"	10-32UNF	KQG2T03-32	8	9.1	13.7	15.2	16.8	12.6	4.5	9		
	1/8	KQG2T03-N01S	12		14.4	15.3	16.6				6	11.8
	1/4	KQG2T03-N02S	14		14.7	16.5	19.3				4.5	19.5
ø1/4"	10-32UNF	KQG2T07-32	8	11.7	14.7	16.5	19.3	13.5	13.9	12.1		
	1/8	KQG2T07-N01S	12		15.9	20.4	21.8				15.1	
	1/4	KQG2T07-N02S	14		22.2	23.3	22.8					
ø5/16"	10-32UNF	KQG2T09-N01S	8	13.7	18.6	18.3	21.9	16.1	26.3	20.4		
	1/4	KQG2T09-N02S	14		19.1	21.5	23.9				26.3	
	3/8	KQG2T09-N03S	19		23.3	25.4	41					
ø3/8"	10-32UNF	KQG2T11-N01S	12	16	20	19.4	24.2	16.6	40.8	27.3		
	1/4	KQG2T11-N02S	14		21	22.6	26.2				30.5	
	3/8	KQG2T11-N03S	19		24.4	27.7	44					
ø1/2"	10-32UNF	KQG2T13-N01S	14	19.6	22.7	24.4	29.8	18.5	57.2	67.4		
	3/8	KQG2T13-N03S	19		23.7	26.1	31.2				41.1	
	1/2	KQG2T13-N04S	22		29.9	33.3	50.2					

* Reference dimensions after installation for NPT thread
Note) Value of FEP tubing.

(10-32UNF)

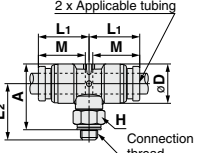

(NPT)

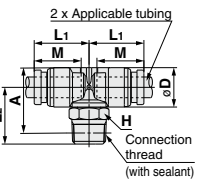

Union Elbow: KQG2L



Applicable tubing O.D. (inch)	Model	øD	L	A	Q	M	øN	øO	Note) Effective area (mm ²)	Weight (g)
ø1/8"	KQG2L01-00	8.3	13.6	19.3	2.9	12	3.2	5.6	3	6.3
ø5/32"	KQG2L03-00	9.1	14.6	20.5	3.1	12.6	3.2	5.6	4.2	7.4
ø1/4"	KQG2L07-00	11.7	16.7	23.2	3.7	13.5	3.2	5.6	11.4	11.5
ø5/16"	KQG2L09-00	13.7	20.1	29.1	5	16.1	4.2	8	21.6	20.2
ø3/8"	KQG2L11-00	16	21.4	31.1	5.7	16.6	4.2	8	35.2	28.2
ø1/2"	KQG2L13-00	19.6	24.9	35.3	6.4	18.5	4.2	8	50.2	41.7

Note) Value of FEP tubing.

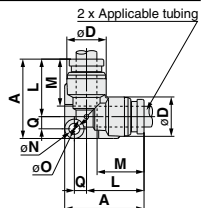

Stainless Steel 316 One-touch Fittings **KQG2 Series**

Applicable Tubing: Inch Size, Connection Thread: UNF, NPT

Dimensions

Bulkhead Union: KQG2E



Applicable tubing O.D. (inch)	Model	T (UNF)	H (Width across flat)	L	Mounting hole	M	Note) Effective area (mm ²)	Weight (g)
ø1/8"	KQG2E01-00	7/16-20UNF	14	34.2	12.5	12	3.4	20.7
ø5/32"	KQG2E03-00	7/16-20UNF	14	34.4	12.5	12.6	5.6	20.5
ø1/4"	KQG2E07-00	1/2-20UNF	17	35.4	14	13.5	13.1	28
ø5/16"	KQG2E09-00	5/8-18UNF	19	39.6	17	16.1	26.1	39.5
ø3/8"	KQG2E11-00	3/4-16UNF	22	40.4	20.5	16.6	41.5	57.3
ø1/2"	KQG2E13-00	7/8-14UNF	26	44.4	23.5	18.5	58.3	83.2

Note) Value of FEP tubing.

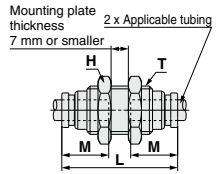

Union Tee: KQG2T



Applicable tubing O.D. (inch)	Model	øD	L	A	Q	M	øN	øO	Note) Effective area (mm ²)	Weight (g)
ø1/8"	KQG2T01-00	8.3	13.6	20.5	4.1	12	3.2	5.6	3.4	7.9
ø5/32"	KQG2T03-00	9.1	14.6	21.8	4.4	12.6	3.2	5.6	6.4	9.5
ø1/4"	KQG2T07-00	11.7	16.7	24.7	5.2	13.5	3.2	5.6	13.4	14.7
ø5/16"	KQG2T09-00	13.7	20.1	31.1	7	16.1	4.2	8	25.6	24.4
ø3/8"	KQG2T11-00	16	21.4	33.4	8	16.6	4.2	8	40	34.7
ø1/2"	KQG2T13-00	19.6	24.9	37.9	9	18.5	4.2	8	57.4	52.3

Note) Value of FEP tubing.

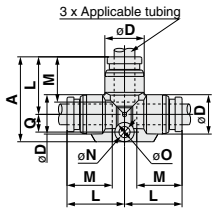

Union "Y": KQG2U



Applicable tubing O.D. (inch)	Model	øD	W	L1	L2	P	M	øN	øO	Note) Effective area (mm ²)	Weight (g)
ø1/8"	KQG2U01-00	8.3	16.4	29	11	8.1	12	3.2	5.6	3.4	9.2
ø5/32"	KQG2U03-00	9.1	18.2	30.4	11.3	9.1	12.6	3.2	5.6	4.2	11.1
ø1/4"	KQG2U07-00	11.7	23.9	34.5	12.1	12.2	13.5	3.2	5.6	13.4	19.6
ø5/16"	KQG2U09-00	13.7	28.3	40.1	14.1	14.6	16.1	4.2	8	25.6	29.7
ø3/8"	KQG2U11-00	16	33.2	42.2	14	17.2	16.6	4.2	8	40	43.1
ø1/2"	KQG2U13-00	19.6	40.2	47.3	15.8	20.6	18.5	4.2	8	57.4	66.4

Note) Value of FEP tubing.

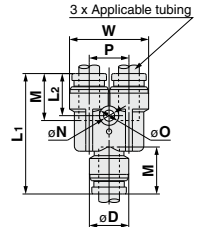

Different Diameter Tee: KQG2T



Applicable tubing O.D. (inch)	Model	øD1	øD2	L1	L2	L3	Q	M1	M2	øN	øO	Note) Effective area (mm ²)	Weight (g)
a 1/8" b 5/32"	KQG2T01-03	9.1	8.3	14.2	14.1	21.1	4.1	12.6	12	3.2	5.6	3.8	8.5
ø5/32" ø1/4"	KQG2T03-07	11.7	9.1	15.5	15.9	22.7	4.4	13.5	12.6	3.2	5.6	7.1	11.7
ø1/4" ø5/16"	KQG2T07-09	13.7	11.7	19.3	17.6	29.6	6.3	16.1	13.5	4.2	8	16.4	20.2
ø5/16" ø3/8"	KQG2T09-11	16	13.7	20.6	21	31.7	7.1	16.6	16.1	4.2	8	36	28.9
ø3/8" ø1/2"	KQG2T11-13	19.6	16	23.3	23	35.4	8.1	18.5	16.6	4.2	8	56	41.8

Note) Value of FEP tubing.

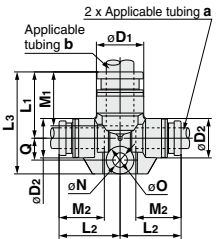

Plug-in Reducer: KQG2R



Applicable tubing O.D. (inch)	Applicable fitting size ød	Model	øD	L	A	M	Note) Effective area (mm ²)	Weight (g)
ø1/8"	ø5/32"	KQG2R01-03	9	32.9	20.3	12	3.4	4.7
ø5/32"	ø1/4"	KQG2R03-07	9	33.7	20.2	12.6	5.6	7.1
ø1/4"	ø5/16"	KQG2R07-09	12	38.4	22.3	13.5	13.1	11.9
ø5/16"	ø3/8"	KQG2R09-11	14	41.6	25	16.1	26.1	16.8
ø3/8"	ø1/2"	KQG2R11-13	17	39.8	21.3	16.6	41.5	23.5

Note) Value of FEP tubing.

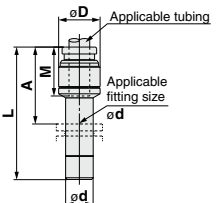

KQG2 Series

Applicable Tubing: Inch Size, Connection Thread: UNF, NPT

Dimensions

Different Diameter Straight: KQG2H



Applicable tubing O.D. (inch)		Model	øD	L	M1	M2	Note) Effective area (mm ²)	Weight (g)
a	b							
ø1/8"	ø5/32"	KQG2H01-03	9	25.6	12	12.6	3.4	6.5
ø5/32"	ø1/4"	KQG2H03-07	12	27.1	12.6	13.5	5.6	11.3
ø1/4"	ø5/16"	KQG2H07-09	14	30.6	13.5	16.1	13.1	16.1
ø5/16"	ø3/8"	KQG2H09-11	16	33.7	16.1	16.6	26.1	22.8
ø3/8"	ø1/2"	KQG2H11-13	20	36.1	16.6	18.5	41.5	37.1

Note) Value of FEP tubing.

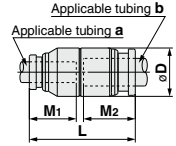

Different Diameter Union "Y": KQG2U



Applicable tubing O.D. (inch)		Model	øD	L1	L2	P	W	M1	M2	øN	øO	Note) Effective area (mm ²)	Weight (g)
a	b												
ø1/8"	ø5/32"	KQG2U01-03	9.1	27	10.8	8.1	16.4	12	12.6	3.2	5.6	3.2	8.5
ø5/32"	ø1/4"	KQG2U03-07	11.7	28.8	11.4	9.1	18.2	12.6	13.5	3.2	5.6	4.2	11.8
ø1/4"	ø5/16"	KQG2U07-09	13.7	33.8	12	12.2	23.9	13.5	16.1	4.2	8	13.4	20
ø5/16"	ø3/8"	KQG2U09-11	16	38.3	13.8	14.6	28.3	16.1	16.6	4.2	8	25.6	31
ø3/8"	ø1/2"	KQG2U11-13	19.6	40.5	13.7	17.2	33.2	16.6	18.5	4.2	8	40	45

Note) Value of FEP tubing.

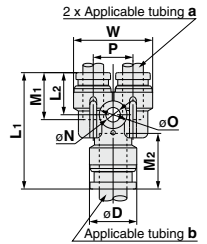

Bulkhead Connector: KQG2E



Applicable tubing O.D. (inch)	Connection thread NPT	Model	T (UNF)	Width across flat		L1	L2	Mounting hole	M	Note) Effective area (mm ²)	Weight (g)
				H1	H2						
ø1/8"	1/4	KQG2E01-N02	7/16-20UNF	17	14	32.8	15.3	12.5	12	3.4	30.6
ø5/32"	1/4	KQG2E03-N02	7/16-20UNF	17	14	32.6	15.3	12.5	12.6	5.6	30.1
ø1/4"	1/4	KQG2E07-N02	1/2-20UNF	17	17	32.7	14.8	14	13.5	13.1	32.6
ø5/16"	3/8	KQG2E09-N03	5/8-18UNF	19	19	35	15.1	17	16.1	26.1	38.2
ø3/8"	3/8	KQG2E11-N03	3/4-18UNF	21	22	33.8	13.3	20.5	16.6	41.5	51.7
ø1/2"	3/8	KQG2E13-N03	7/8-14UNF	24	26	34.6	12.3	23.5	18.5	58.3	73.2
	1/2	KQG2E13-N04		24	26	41.4	19.1				

Note) Value of FEP tubing.

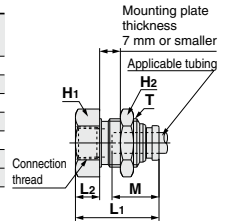

Extended Male Elbow: KQG2W



Applicable tubing O.D. (inch)	Connection thread NPT	Model	H (Width across flat)	øD	L1	L2	A*	M	Note) Effective area (mm ²)	Weight (g)		
											ø1/8"	1/8
1/4	KQG2W01-N02S	14	35.4	35.1								
ø5/32"	1/8	KQG2W03-N01S	12	9.1	14.4	32	33.3	12.6	4	22.4		
	1/4	KQG2W03-N02S	14								35.8	35.9
ø1/4"	1/8	KQG2W07-N01S	12	11.7	15.9	33.3	35.9	13.5	10.9	37		
	1/4	KQG2W07-N02S	14								37.1	38.5
	3/8	KQG2W07-N03S	19								38.9	40
ø5/16"	1/8	KQG2W09-N01S	12	13.7	19.1	34.7	38.3	16.1	20.5	26.9		
	1/4	KQG2W09-N02S	14								40.2	42.6
	3/8	KQG2W09-N03S	19								42	44.1
ø3/8"	1/4	KQG2W11-N02S	14	16	21	47.2	50.8	16.6	33.5	41.8		
	3/8	KQG2W11-N03S	19								45.4	48.7
	1/2	KQG2W11-N04S	22								49.2	50.8
ø1/2"	1/4	KQG2W13-N02S	14	19.6	23.7	50.7	55.8	18.5	47.7	47.9		
	3/8	KQG2W13-N03S	19								50.7	55.8
	1/2	KQG2W13-N04S	22								54.5	57.9

* Reference dimensions after installation of NPT thread
Note) Value of FEP tubing.

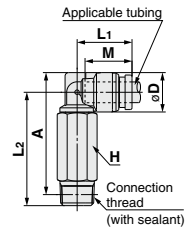

Dimensions

Female Connector: KQG2F



Applicable tubing O.D. (inch)	Connection thread NPT	Model	H (Width across flat)	Note 1) ϕD	L1	L2	M	Note 2) Effective area (mm ²)	Weight (g)
$\phi 1/8"$	1/8	KQG2F01-N01	12	8	24.1	10.4	12	3.4	9.4
	1/4	KQG2F01-N02	17		29.1	13.7			22.5
$\phi 5/32"$	1/8	KQG2F03-N01	12	8.7	24.6	10.5	12.6	5.6	9.9
	1/4	KQG2F03-N02	17		29.6	13.8			23
$\phi 1/4"$	1/8	KQG2F07-N01	12	11.2	25	10.7	13.5	13.1	11.1
	1/4	KQG2F07-N02	17		30	14.1			24.5
	3/8	KQG2F07-N03	19		31.2	14.6			25.5
$\phi 5/16"$	1/8	KQG2F09-N01	14	13.4	27.2	10.3	16.1	26.1	17.3
	1/4	KQG2F09-N02	17		32.2	14.3			26.9
	3/8	KQG2F09-N03	19		33.4	14.8			28.1
$\phi 3/8"$	1/4	KQG2F11-N02	17	16	32.1	14.4	16.6	41.5	29.7
	3/8	KQG2F11-N03	19		33.3	14.9			30.9
	1/2	KQG2F11-N04	24		38.6	18.6			49.1
$\phi 1/2"$	3/8	KQG2F13-N03	21	19.3	34.6	14.7	18.5	58.3	43.3
	1/2	KQG2F13-N04	24		39.9	18.8			53.5

Note 1) For the $\phi 3/8"$, this dimension refers to the O.D. of the release button.
Note 2) Value of FEP tubing.

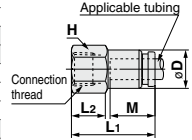

Plug: KQG2P



Applicable fitting size ϕd	Model	ϕD	L	A	Weight (g)
$\phi 1/8"$	KQG2P-01	5	28.9	16.9	2.7
$\phi 5/32"$	KQG2P-03	6	29.6	17	4.1
$\phi 1/4"$	KQG2P-07	8	30.3	16.8	8.9
$\phi 5/16"$	KQG2P-09	10	33.7	17.6	15.5
$\phi 3/8"$	KQG2P-11	11	34.1	17.5	21
$\phi 1/2"$	KQG2P-13	14	36.4	17.9	38.5

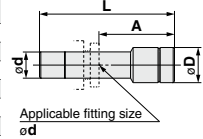



KQG2 Series

Applicable Fluid List

How to Read the Table

- ⊙: Completely unaffected or largely unaffected.
- : May be slightly affected, but, dependent upon condition, can sufficiently withstand.
- △: Advisable to use as little as possible.
- ×: Not applicable, as substantially affected.
- : No data is available.

Compatibility Checklist for Used Materials and Fluids

Chemical	Body	Seal
	Stainless steel 316	Special FKM
Acrylonitrile	⊙	×
Acetamide	○	○
Acetaldehyde	⊙	×
Acetone	⊙	×
Aniline	○	⊙
Amylene	⊙	—
Sulphurous acid gas (Humid gas)	⊙	—
Sodium bisulfite [50%]	⊙	—
Allyl alcohol	⊙	—
Benzoic acid	⊙	—
Ammonia (Compressed gas)	⊙	×
Isopropyl alcohol	○	⊙
Isophorone	×	—
Ethyl alcohol	⊙	○
Ethyl ether	○	×
Ethylene	⊙	—
Ethylene glycol	○	⊙
Ethylene diamine	⊙	—
Ethylene dichloride	⊙	—
Epichlorohydrine	⊙	×
Methyl tertiary butyl ether	—	×
Allyl chloride	×	—
Ammonium chloride	⊙	—
Calcium chloride	⊙	—
Iron(II) chloride [5%]	×	—
Sodium chloride	○	—
Magnesium chloride	⊙	—
Hydrochloric acid [5%]	×	—
Chlorine gas (Humid gas)	×	—
Carbitol	×	—
Formic acid [50%]	○	×
o-Xylene	△	△
p-Xylene	△	△
Citric acid	⊙	—
Cumene	×	—
Glycerin	⊙	⊙
Cresol	⊙	△

Chemical	Body	Seal
	Stainless steel 316	Special FKM
Chromic acid [10%]	⊙	—
Chlorosulfonic acid	○	×
Chlorofluorocarbon (CFC) 11	—	×
Chlorofluorocarbon (CFC) 113	—	×
Chlorofluorocarbon (CFC) 12	○	×
Chlorofluorocarbon (CFC) 13B1	—	×
Chlorofluorocarbon (CFC) 14	—	⊙
Chlorofluorocarbon (CFC) 22	○	×
Chlorobenzene	×	○
Chloroform (Trichloromethane)	○	○
Acetic acid	○	×
Amyl acetate	⊙	×
Isopropyl acetate [20%]	⊙	×
Ethyl acetate	×	×
Butyl acetate	×	×
Methyl acetate	⊙	×
Calcium hypochlorite	⊙	—
Sodium hypochlorite [5%]	⊙	⊙
Potassium cyanide [50%]	⊙	—
Copper cyanide	⊙	—
Diisobutyl ketone	⊙	—
Diisobutylene	—	⊙
Diethanolamine	⊙	—
Diethylamine	×	×
Diethylene glycol	⊙	—
Carbon tetrachloride	⊙	⊙
Cyclohexanol	×	—
Cyclohexanone	×	×
Cyclohexane	×	○
Dichloroethylene	—	△
Dichlorobenzene	—	△
Dichloromethane (Methylene chloride)	△	△
Ethylene bromide	×	—
Potassium bromide [30%]	⊙	—
Potassium dichromate [25%]	⊙	—
Oxalic acid	⊙	—
Bromine gas	×	—

Chemical	Body	Seal
	Stainless steel 316	Special FKM
Tartaric acid	○	—
Nitric acid [65%]	○	○
Ammonium nitrate	○	—
Ammonium hydroxide	—	○
Calcium hydroxide	○	—
Sodium hydroxide [50%]	○	○
Barium hydroxide	○	—
Solvent naphtha	○	—
Carbonic acid (Humid gas and aqueous solution)	○	—
Tetrachloroethylene	×	○
Tetrahydrofuran	—	×
Dodecylbenzene	○	—
Trichloroethane	△	—
Trichloroethylene	○	○
Trichloroacetic acid	—	—
Toluene	○	○
Naphtha	○	○
Naphthenic acid	○	—
Lactic acid	○	—
Carbon disulfide	○	○
Picric acid	○	—
Pyridine	×	×
Phenol	×	○
Butyl phthalate	×	—
Butyl alcohol	△	—
Hydrofluoric acid [50%]	○	—
Furfural	×	×
n-Propyl alcohol	○	—
Propylene glycol	○	—
Bromochloroethane	—	×
n-Hexane	○	○
n-Hexyl alcohol	○	—
n-Heptane	○	—
Benzene	×	×
n-Pentane	×	—
Boric acid	○	—
Gallic acid	○	—

Chemical	Body	Seal
	Stainless steel 316	Special FKM
Formic aldehyde	○	×
Methyl methacrylate	×	×
Methyl alcohol	○	○
Methyl isobutyl ketone	×	×
Methyl ethyl ketone	×	×
Ethyleneglycol monomethyl ether	×	—
Monoethanolamine	○	—
Morpholine	○	—
Butyric acid	○	—
Hydrogen sulfide (Humid gas and aqueous solution)	○	×
Sulphuric acid [10%]	○	○
Ammonium sulfate	○	×
Sodium bisulfate [10%]	○	—
Iron(II) sulfate	○	—
Sodium sulfate	○	—
Phosphoric acid [85%]	○	—

Note 1) [] denotes the concentration. Aqueous solutions without condensation notes are in a saturated state.

Note 2) The above data is based on a room temperature of 20°C. Note that you may obtain different figures, depending on temperature conditions.

Note 3) The above data shows compatibility guidelines based upon component parts. Therefore, it is no guarantee of product performance. In addition, using fluids other than those specified in the catalog are not covered by the product's warranty.



KQG2 Series

Specific Product Precautions

Be sure to read this before handling the products.

Refer to page 11 for safety instructions and pages 14 to 18 for fittings and tubing precautions.

Selection

⚠ Caution

1. The surge pressure must be under the maximum operating pressure. If the surge pressure exceeds the maximum operating pressure, it will result in damage to fittings and tubing or the tubing may result in being fallen out.
2. If using a fluororesin tubing in an environment where the fluid temperature changes drastically, it is recommended to use an inner sleeve. Otherwise, air leakage may occur or the tube may release from fitting due to deformation of the tubing.
3. The particle generation of the KQG2 series depends on the operating conditions and operating environment. If you are concerned about the effects on machinery and equipment, check the particle generation with your machine before use.

The components of the KQG2 series may slide due to changes in the internal pressure, which may generate particles. When using male elbow, male branch tee, and extended male elbow fittings, particles may be generated by rotation for positioning after connecting.

Mounting

⚠ Caution

1. When performing the piping work, turn the tightening tool in the horizontal direction to the hex across flats of the stud so that any moment is not applied to the body.

If the tool is in contact with the body, this may cause the stud to come off.

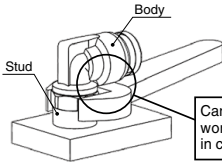

2. The union elbow, union tee, union "Y", different diameter tee and different diameter union "Y" should be fixed through the mounting hole.

Otherwise, air leakage or breaking can occur due to a pulling force or moment load created by the product's weight.

3. The elbow union, branch tee, and long elbow union can be turned for positioning after connecting, but they cannot be used while turning them.

Doing so may cause worn out metallic particles to enter the fluid or the fitting to break.

4. If the connection tube oscillates or turns, do not use this product.

Doing so may cause the fitting to break. In particular, for the product with the stud, this may cause the stud to come off.

Operating Environment

⚠ Warning

1. Avoid installing and using fittings inside a food zone.

Not installable

Food zone An environment where food which will be sold as merchandise, directly touches the fitting components.

Installable

Splash zone An environment where food which will not be sold as merchandise, directly touches the fitting components.

Non-food zone An environment where there is no contact with food.

Installation and Removal of Tubing

⚠ Caution

1. Installation of tubing

1) Grease is not used for the KQG2 series, therefore a greater insertion force is required when the tube is installed. In particular, polyurethane tubing may fold when inserted due to its softness. Hold the end of the tubing, and insert it all the way in slowly and securely. Refer to dimension "M" in the dimension drawings for guidance on the insertion depth of tube.

2. Removal of tubing

1) For tubing used at a high temperature or for an extended period of time, there is a possibility that it will not fit into a One-touch fitting again due to an enlarged O.D. Dispose of the tubing and replace it with a new one.

Proper Tightening Torque of Fittings

⚠ Caution

1. Tighten fittings with sealant using the proper tightening torques in the table below. As a rule, they should be tightened 2 to 3 turns with a tool after first tightening by hand.

If tightened using a torque exceeding the proper torque level, this may cause the fitting to break.

In particular, for the product with the stud, the stud may come off.

Connection thread size	Proper tightening torque N·m
NPT, R1/8	3 to 5
NPT, R1/4	8 to 12
NPT, R3/8	15 to 20
NPT, R1/2	20 to 25

Stainless steel

Metal exists in nature as ore (like oxide or sulfide). This means that oxide or sulfide is more stable than pure metal. Accordingly, metallic material chemically oxidizes (metallic constituent becomes ion and melts out). It corrodes in the natural environment. Even though corrosion of metal easily occurs in an environment where oxidizing tendency is stronger, some kinds of metal have a characteristic for which corrosion never happens if the level of oxidizing goes higher than a specific point. In such a case, it is called "metal in passive state".

Stainless steel has corrosion resistance because of a thin coat of passive state on its surface. However, there does not exist stainless steel with absolute corrosion resistance; therefore, many types of stainless steel have been developed for improved corrosion resistance performance.