





Smooth Cylinder/Low Speed Cylinder



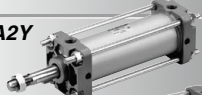

Series C□Y/C□X

Series Variations

Smooth Cylinder **CQSY/CQ2Y/CM2Y/CG1Y/CA2Y/CS2Y**P. 1167

Series	Action	Bore size (mm)	Minimum operating pressure (MPa)	Page
CQSY 	Double acting	12, 16	0.03	P.1168
		20, 25	0.02	
CQ2Y 		32, 40	0.02	P.1176
		50, 63, 80, 100	0.01	
CM2Y 		20, 25, 32, 40	0.02	P.1189
CG1Y 		20, 25, 32, 40	0.02	P.1203
		50, 63, 80, 100	0.01	
CA2Y 		40	0.02	P.1214
		50, 63, 80, 100	0.01	
CS2Y 		125, 140, 160	0.005	P.1228

Low Speed Cylinder **CJ2X/CUX/CQSX/CQ2X/CM2X**P. 1243

Series	Action	Bore size (mm)	Minimum operating speed (mm/s)	Page
CJ2X 	Double acting	10, 16	1	P.1246
CUX 		10, 16	1	P.1256
		20, 25, 32	0.5	
CQSX 		12, 16	1	P.1261
		20, 25	0.5	
CQ2X 		32, 40, 50, 63, 80, 100	0.5	P.1268
		CM2X 	20, 25, 32, 40	0.5

REA

REB

REC

Y

X

MQ

RHC

RZQ

D

X

Smooth Cylinder/Low Speed Cylinder

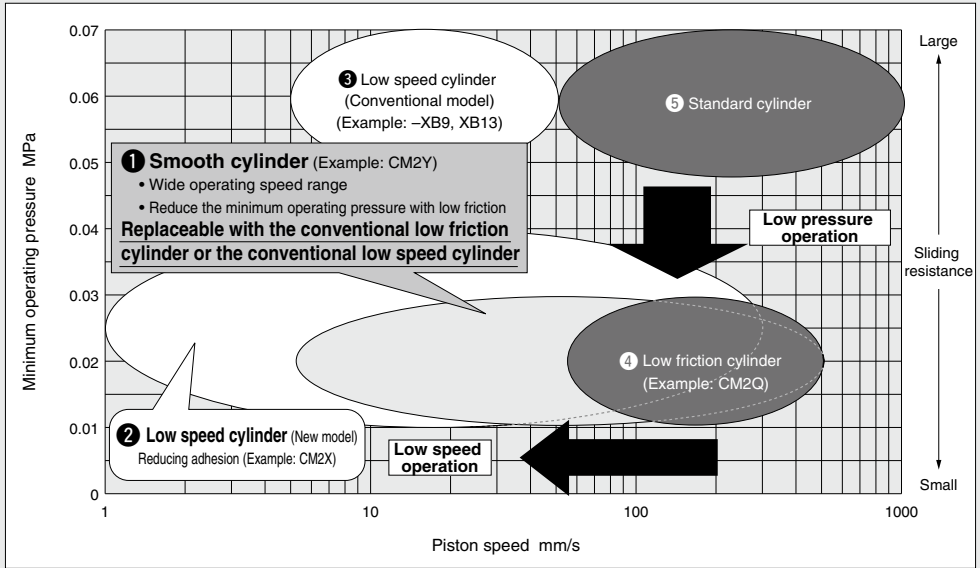

1 Smooth cylinder

- Low speed operation (from 5 mm/s)
- Low pressure operation
- Pressure on both sides
 - Pressing force control
 - Balance control of winders, etc.
 - General low-speed operating applications
 - Tension control

2 Low speed cylinder (New model)

- Low speed operation (from 1 mm/s)
- Low pressure operation
- Pressure on both sides
- Reducing adhesion
 - Load transfer without a lateral load (Lightweight trays, etc.)
 - Transfer with less adhesion (Wafers, etc.)
 - Higher-accuracy pressing force control

3 Low speed cylinder (Conventional model)

- Low speed operation

4 Low friction cylinder

- Low pressure operation
- Pressure on a single side

5 Standard non-lube cylinder

- General applications

Superiority in low speed/low friction

Function	1 Smooth cylinder	2 Low speed cylinder (New model)	3 Low speed cylinder (Conventional model)	4 Low friction cylinder	5 Standard non-lube cylinder
① Low pressure operation	○	CJ2X, CUX10 : x Others : ○	△	○	△
② Low speed operation	○	○	○	△	△
③ Reducing adhesion	○	○	○	△	△
④ Reducing protrusion	○	○	○	△	△
⑤ Pressing force control	○	CJ2X, CUX10 : x Others : ○	○	△	△
⑥ Low sliding	○	○	○	○	△

◎: Excellent ○: Good △: Usable x: Handle with caution

Selection Procedures

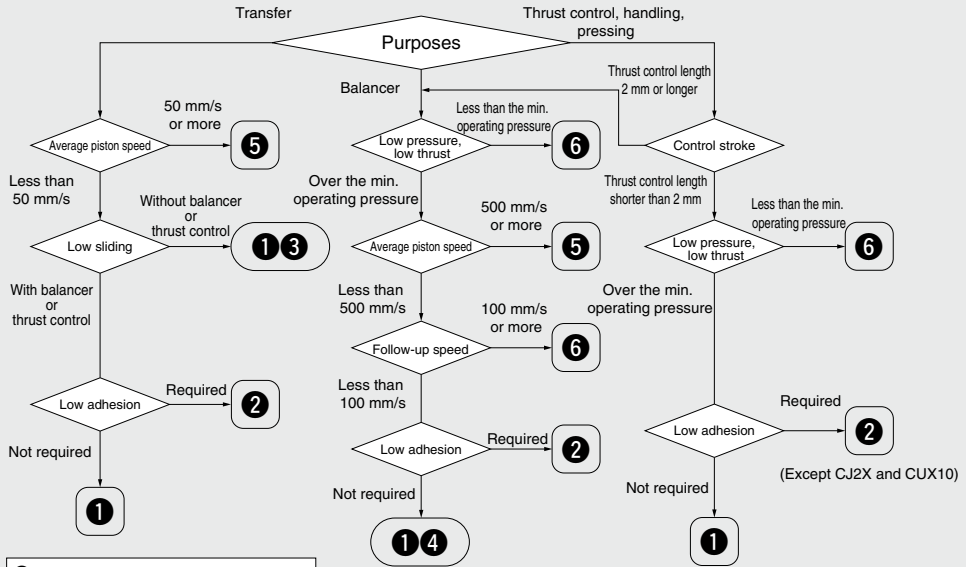

- ① Consider using the smooth cylinder.
- ② Consider using the low speed cylinder (new model).
- ③ Consider using the low speed cylinder (conventional model).
- ④ Consider using the low friction cylinder
- ⑤ Consider using the standard non-lube cylinder
- ⑥ Consult with SMC.

Glossary explanation

Average piston speed	Cylinder full stroke (length) divided by air pressure operating time.
Adhesive phenomenon	Protrusion or delay occurs when cylinders are not operated for long hours.
Thrust control	Control the pressing force by controlling air pressure in the cylinder.
Balancer	Cylinders move along with the moving workpiece.
Balancer follow-up speed	The speed of an air cylinder moving along with the workpiece at a small stroke.
Calculating thrust controlled.	Calculate the cylinder thrust multiplying piston area by pressure. Piston area varies depending on models and bore sizes.

Applicable Model/Size

Type	① Smooth cylinder	② Low speed cylinder (New model)	③ Low speed cylinder (Conventional model)	④ Low friction cylinder	Representative model
Compact	●	●	●		CQS
	●	●	●		CQ2
Round	●	●		*	CM2
	●		●	*	CG1
Tie-rod			●	*	MB
	●			*	CA2
	●			**	CS1
Small		●	●	●	CJ2
		●	●		CU

- : Standard
- *: ① Change this to a smooth cylinder.
- ** : ① Change this to a smooth cylinder (CS2).

Bore size (mm)	① Smooth cylinder					② Low speed cylinder (New model)					
	Compact	Round	Tie-rod	Compact	Round	Small	Free mount				
ø10											
ø12	●										
ø16	●										
ø20	●					●	●				
ø25	●	●	●	●	●		●				
ø32	●	●	●	●	●		●				
ø40	●	●	●	●	●		●				
ø50	●	●	●	●	●		●				
ø63	●	●	●	●	●		●				
ø80	●	●	●	●	●		●				
ø100	●	●	●	●	●		●				
ø125				●							
ø140				●							
ø160				●							
Model	CQS	CQ2	CM2	CG1	CA2	CS2	CQSX	CQ2X	CM2X	CJ2X	CUX
	P. 1168	P. 1176	P. 1189	P. 1203	P. 1214	P. 1228	P. 1261	P. 1268	P. 1280	P. 1246	P. 1256

REA

REB

REC

CQY

CQX

MQ

RHC

RZQ

D-□

-X□

Added compact type foot brackets.

- Compact foot bracket has the same width as the cylinder. Overall width reduced by up to **43%** (for $\varnothing 12$).

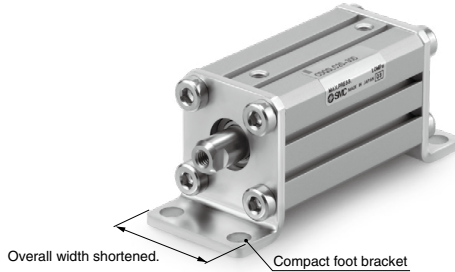

■ More compact installation space possible

- Short pitch mounting is possible. ● Allows installation close against a wall.

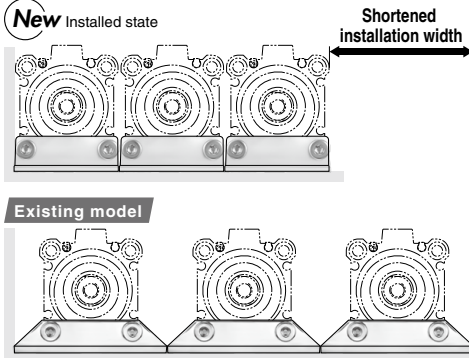

Bore size (mm)	New Compact foot type width A (mm)	Existing foot type width B (mm)	Reduced width for short pitch mounting (mm)		
			1 unit	2 units	3 units
12	25	44	19	38	57
16	29	48	19	38	57
20	36	62	26	52	78
25	40	66	26	52	78
32	45	71	26	52	78
40	52	78	26	52	78
50	64	95	31	62	93
63	77	113	36	72	108
80	98	140	42	84	126
100	117	162	45	90	135

* Short pitch mounting is possible only without auto switch. Consult with SMC for mounting with auto switch.

- Height from the bottom of brackets to the center of a cylinder is the same as the existing model.

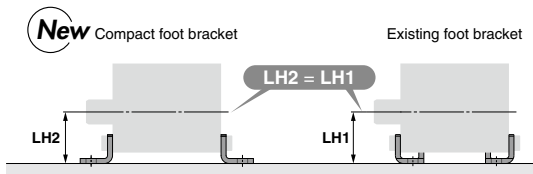

Applicable Cylinders: CQSY, CQ2Y (Smooth Cylinder), CQSX, CQ2X (Low Speed Cylinder)

Smooth Cylinder

Series **CQSY/CQ2Y/CM2Y/CG1Y/CA2Y/CS2Y**

ø12 to ø25 ø32 to ø100 ø20 to ø40 ø20 to ø100 ø40 to ø100 ø125 to ø160



Minimum operating pressure **0.005 to 0.03 MPa**

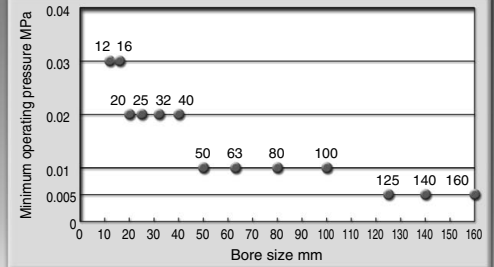

(Measurement based on JIS B 8377)

Stable operation possible even at a low speed of 5 mm/s (Measurement based on JIS B 8377)

Smooth operation with less sticking and slipping

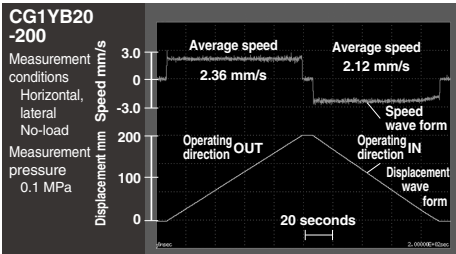
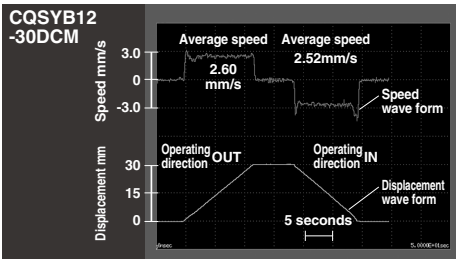

Sliding resistance

Bi-directional low-friction operation possible.

Pressure can be controlled regardless of its direction.

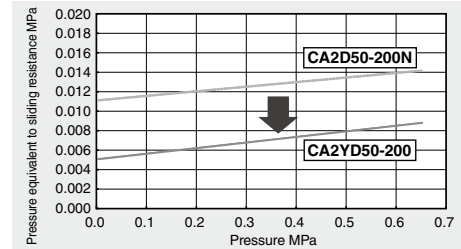

Application Example

Smooth cylinder combined with precision regulator (e.g. Series IR)

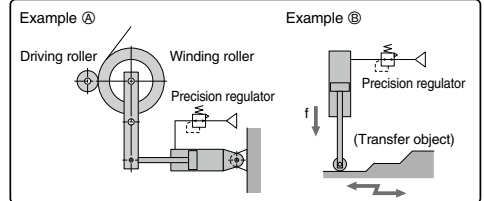

- REA
- REB
- REC
- CQY
- CQX
- MQ
- RHC
- RZQ

- D-□
- X□

Smooth Cylinder

Series CQSY

ø12, ø16, ø20, ø25

How to Order

CQSY B 20 - 30 D C

With auto switch CDQSY B 20 - 30 D C - M9BW

With auto switch
(Built-in magnet)

Mounting style

B	Through-hole/Both ends tapped (Standard)
L	Foot style ^{Note)}
LC	Compact foot style
F	Rod side flange style
G	Head side flange style
D	Double clevis style

* Mounting brackets are not mounted and are supplied loose at the time of shipment.

Bore size

12	12 mm
16	16 mm
20	20 mm
25	25 mm

Cylinder stroke (mm)
Refer to "Standard Stroke" on page 1169.

Number of auto switches

Nil	2 pcs.
S	1 pc.
n	n pcs.

Auto switch

Nil	Without auto switch
-----	---------------------

*For the applicable auto switch model, refer to the table below.

Bumper/Rod end thread

C	Rubber bumper & Rod end female thread
CM	Rubber bumper & Rod end male thread

Action

D	Double acting
---	---------------

Built-in Magnet Cylinder Model
If a built-in magnet cylinder without an auto switch is required, there is no need to enter the symbol for the auto switch.
(Example) CDQSYL25-30DC

Applicable Auto Switches/Refer to pages 1893 to 2007 for further information on auto switches.

Type	Special function	Electrical entry	Indicator light	Wiring (Output)	Load voltage		Auto switch model		Lead wire (m)					Pre-wired connector	Applicable load						
					DC	AC	Perpendicular	In-line	0.5 (Nil)	1 (M)	3 (L)	5 (Z)	IC circuit		PLC						
Solid state auto switch	—	Grommet	Yes	3-wire (NPN)	24 V	—	M9NV	M9N	●	●	○	○	—	—	—	—					
				3-wire (PNP)			M9PV	M9P	●	●	○	○									
				2-wire			M9BV	M9B	●	●	○	○									
				3-wire (NPN)			M9NVV	M9NV	●	●	○	○									
	Diagnostic indication (2-color)	Grommet	Yes	3-wire (PNP)	24 V	—	M9PWV	M9PW	●	●	○	○	—	—	—	—	—				
				2-wire			M9BVV	M9BW	●	●	○	○									
	Water resistant (2-color indication)	Grommet	Yes	3-wire (NPN)	24 V	—	M9NAV***	M9NA***	○	○	●	○	—	—	—	—	—				
				3-wire (PNP)			M9PAV***	M9PA***	○	○	●	○									
Magnetic field resistant (2-color indication)	Grommet	Yes	2-wire	24 V	12 V	M9BAV***	M9BA***	○	○	●	○	—	—	—	—	—					
			2-wire (Non-polar)			—	P3DW***	●	—	●	○										
Reed auto switch	—	Grommet	Yes	3-wire (Equiv. NPN)	24 V	12 V	A96V	A96	●	—	●	—	—	—	—	—					
				2-wire			100 V	A93V	A93	●	—	●					●	—	—	—	—
							100V or less	A90V	A90	●	—	●					—				

*** Water resistant type auto switches can be mounted on the above models, but in such case SMC cannot guarantee water resistance. Consult with SMC regarding water resistant types with the above model numbers.

* Lead wire length symbols: 0.5 m Nil (Example) M9NV
1 m M (Example) M9NWM
3 m L (Example) M9NWL
5 m Z (Example) M9NWZ

○: Manufactured upon receipt of order.

** D-P3DW□ is compatible with ø25.

It is mounted away from the port side to avoid interference with fittings.

* In addition to the models in the above table, there are some other auto switches that are applicable. For more information, refer to page 1175.

* Refer to pages 1960 and 1961 for details of auto switches with a pre-wired connector. For D-P3DWC, refer to pages 1948 and 1949.

* Auto switches are not mounted and are supplied loose at the time of shipment.

Note) Please also confirm whether the selected auto switch can be mounted at the desired position. Auto switches of models D-A9CV, M9□V, M9□WV and M9□AV may not be mounted on the side with ports due to the cylinder stroke or the size of the fittings.

Specifications

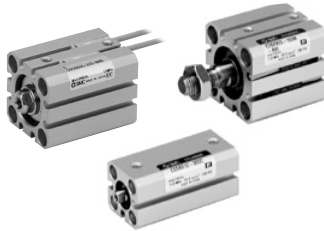

Bore size (mm)	12	16	20	25
Type	Pneumatic (Non-lube)			
Action	Double acting, Single rod			
Fluid	Air			
Proof pressure	1.05 MPa			
Maximum operating pressure	0.7 MPa			
Ambient and fluid temperature	Without auto switch -10 to 70°C (with no freezing)			
	With auto switch -10 to 60°C (with no freezing)			
Cushion	Rubber bumper			
Rod end thread	Female thread			
Stroke length tolerance	+1.0 mm (Note) 0			
Operating piston speed	5 to 500 mm/s			
Allowable leakage rate	0.5 L/min (ANR) or less			

Note) Stroke length tolerance does not include the amount of bumper change.

Symbol

Rubber bumper

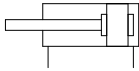

Minimum Operating Pressure

Bore size (mm)	Unit: MPa		
	12	16	25
Minimum operating pressure	0.03		0.02

Standard Stroke

Bore size (mm)	Standard stroke (mm)
12, 16	5, 10, 15, 20, 25, 30
20, 25	5, 10, 15, 20, 25, 30, 35, 40, 45, 50

Replacement Parts: Seal Kit

Bore size (mm)	Kit no.	Contents
12	CQSY12-PS	Piston seal 1 pc.
16	CQSY16-PS	Rod seal 1 pc.
20	CQSY20-PS	Tube gasket 1 pc.
25	CQSY25-PS	Grease pack (10 g) 1 pc.

When only grease for maintenance is necessary, please order by the following part numbers.

Grease pack part no.: GR-L-005 (5 g)
GR-L-010 (10 g)
GR-L-150 (150 g)

Theoretical Output

Bore size (mm)	Rod size (mm)	Operating direction	Piston area (mm ²)	Operating pressure (MPa)			Unit: N
				0.3	0.5	0.7	
12	6	IN	84.8	25	42	59	
		OUT	113	34	57	79	
16	8	IN	151	45	75	106	
		OUT	201	60	101	141	
20	10	IN	236	71	118	165	
		OUT	314	94	157	220	
25	12	IN	378	113	189	264	
		OUT	491	147	245	344	

Intermediate Stroke

Method	Installation of spacer on standard stroke body.		
Model no.	Refer to page 1168 for standard model no.		
Standard stroke	Method	Intermediate strokes at 1 mm intervals are available by using spacers with standard stroke cylinders.	
	Stroke range	Bore size (mm)	Stroke range (mm)
		12, 16	1 to 29
20, 25	1 to 49		
Example	Part no.: CQSYB25-47DC CQSYB25-50DC with 3 mm width spacer inside. B dimension is 77.5 mm. Calculation: $\phi 25$, B dimension 27.5 mm (without auto switch) 27.5 (B dimension) + 50 (st) = 77.5 (mm)		

REA

REB

REC

COY

COX

MQ

RHC

RZQ

D-□

-X□

Series CQSY

Weight/Without Auto Switch (g)

Bore size (mm)	Cylinder stroke (mm)									
	5	10	15	20	25	30	35	40	45	50
12	37	43	50	57	63	70	—	—	—	—
16	49	57	66	74	83	92	—	—	—	—
20	75	88	101	114	127	140	153	165	178	191
25	109	125	140	156	172	188	204	220	236	252

For standard strokes

Calculation: (Example) CQSYD20-20DCM

• Basic weight: CQSYB20-20DC 114 g
 • Additional weight: Rod end male thread 10 g
 : Double clevis style 92 g

 216 g

Weight/With Auto Switch (Built-in magnet) (g)

Bore size (mm)	Cylinder stroke (mm)									
	5	10	15	20	25	30	35	40	45	50
12	45	51	58	65	71	78	—	—	—	—
16	59	67	76	85	94	103	—	—	—	—
20	106	119	132	145	157	170	183	195	208	221
25	151	167	183	199	215	231	246	262	278	294

Additional Weight (g)

Bore size (mm)		12	16	20	25
Rod end male thread	Male thread	1.5	3	6	12
	Nut	1	2	4	8
Foot style (Including mounting bolt)		55	65	159	181
Compact foot style (Including mounting bolt)		30	36	91	107
Rod side flange style (Including mounting bolt)		58	70	143	180
Head side flange style (Including mounting bolt)		56	66	137	171
Double clevis style (Including pin, snap ring, bolt)		34	40	92	127

Mounting Bolt for CQSYB without Auto Switch

Mounting method: Mounting bolt for through-hole mounting style of CQSYB is available as an option.

Refer to the following for ordering procedures. Order the actual number of bolts that will be used.

Example) CQ-M3x30 L 4 pcs.

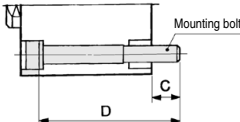

Note) When mounting a cylinder with through-hole, be sure to use the attached plain washer.

Cylinder model	C	D	Mounting bolt part no.
CQSYB12-5DC	6.5	30	CQ-M3 x 30L
		-10DC	35 x 35L
		-15DC	40 x 40L
		-20DC	45 x 45L
		-25DC	50 x 50L
		-30DC	55 x 55L
CQSYB16-5DC	6.5	30	CQ-M3 x 30L
		-10DC	35 x 35L
		-15DC	40 x 40L
		-20DC	45 x 45L
		-25DC	50 x 50L
		-30DC	55 x 55L
CQSYB20-5DC	6.5	30	CQ-M5 x 30L
		-10DC	35 x 35L
		-15DC	40 x 40L
		-20DC	45 x 45L
		-25DC	50 x 50L
		-30DC	55 x 55L

Cylinder model	C	D	Mounting bolt part no.
CQSYB20-25DC	6.5	50	CQ-M5 x 50L
		-30DC	55 x 55L
		-35DC	60 x 60L
		-40DC	65 x 65L
		-45DC	70 x 70L
		-50DC	75 x 75L
CQSYB25-5DC	8.5	35	CQ-M5 x 35L
		-10DC	40 x 40L
		-15DC	45 x 45L
		-20DC	50 x 50L
		-25DC	55 x 55L
		-30DC	60 x 60L
		-35DC	65 x 65L
		-40DC	70 x 70L
-45DC	75 x 75L		
-50DC	80 x 80L		

Material: Chromium molybdenum steel
 Surface treatment: Zinc chromated

Mounting Bolt for CDQSYB with Auto Switch

Mounting method: Mounting bolt for through-hole mounting style of CDQSYB is available as an option.

Refer to the following for ordering procedures. Order the actual number of bolts that will be used.

Example) CQ-M3x35 L 4 pcs.

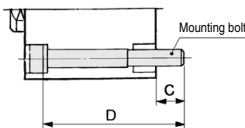

Note) When mounting a cylinder with through-hole, be sure to use the attached plain washer.

Cylinder model	C	D	Mounting bolt part no.
CDQSYB12-5DC	6.5	35	CQ-M3 x 35L
		-10DC	40 x 40L
		-15DC	45 x 45L
		-20DC	50 x 50L
		-25DC	55 x 55L
		-30DC	60 x 60L
CDQSYB16-5DC	6.5	35	CQ-M3 x 35L
		-10DC	40 x 40L
		-15DC	45 x 45L
		-20DC	50 x 50L
		-25DC	55 x 55L
		-30DC	60 x 60L
CDQSYB20-5DC	6.5	40	CQ-M5 x 40L
		-10DC	45 x 45L
		-15DC	50 x 50L
		-20DC	55 x 55L
		-25DC	60 x 60L
		-30DC	65 x 65L

Cylinder model	C	D	Mounting bolt part no.
CDQSYB20-25DC	6.5	60	CQ-M5 x 60L
		-30DC	65 x 65L
		-35DC	70 x 70L
		-40DC	75 x 75L
		-45DC	80 x 80L
		-50DC	85 x 85L
CDQSYB25-5DC	8.5	45	CQ-M5 x 45L
		-10DC	50 x 50L
		-15DC	55 x 55L
		-20DC	60 x 60L
		-25DC	65 x 65L
		-30DC	70 x 70L
		-35DC	75 x 75L
		-40DC	80 x 80L
-45DC	85 x 85L		
-50DC	90 x 90L		

Material: Chromium molybdenum steel
 Surface treatment: Zinc chromated

- REA
- REB
- REC
- C□Y**
- C□X
- MQ
- RHC
- RZQ

- D-□
- X□

Series CQSY

Dimensions/ø12 to ø25

Basic style
(Through-hole/Both ends tapped):
CQSYB/CDQSYB

ø12

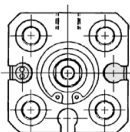

ø16

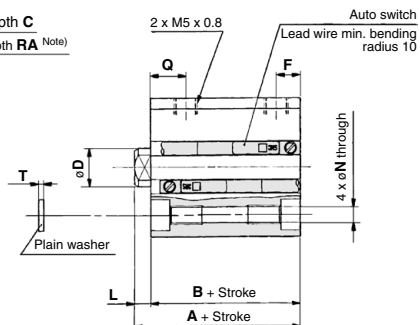
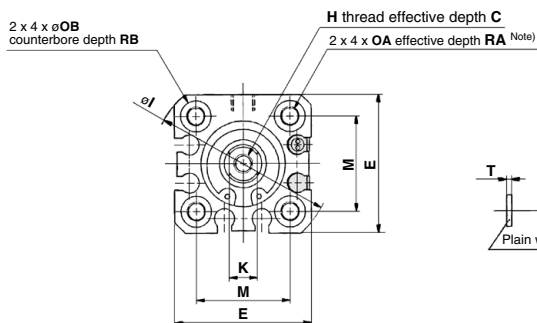

ø20, ø25

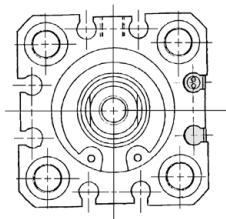

Rod end male thread

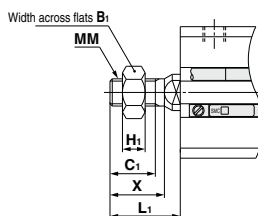

Rod End Male Thread

Bore size (mm)	B ₁	C ₁	H ₁	L ₁	MM	X
12	8	9	4	14	M5 x 0.8	10.5
16	10	10	5	15.5	M6 x 1.0	12
20	13	12	5	18.5	M8 x 1.25	14
25	17	15	6	22.5	M10 x 1.25	17.5

Basic Style

Bore size (mm)	Stroke range (mm)	Without auto switch		With auto switch		C	D	E	F	H	I	K	L	M	N	OA	OB	Q	RA	RB	T
		A	B	A	B																
12	5 to 30	25.5	22	30.5	27	6	6	25	5	M3 x 0.5	32	5	3.5	15.5	3.5	M4 x 0.7	6.5	7.5	7	4	0.5
16	5 to 30	25.5	22	30.5	27	8	8	29	5	M4 x 0.7	38	6	3.5	20	3.5	M4 x 0.7	6.5	7.5	7	4	0.5
20	5 to 50	29	24.5	39	34.5	7	10	36	5.5	M5 x 0.8	47	8	4.5	25.5	5.4	M6 x 1.0	9	8	10	7	1
25	5 to 50	32.5	27.5	42.5	37.5	12	12	40	5.5	M6 x 1.0	52	10	5	28	5.4	M6 x 1.0	9	9	10	7	1

Note) Threaded through hole is used for the standard of ø20 with 5 to 10 mm strokes and ø25 with a 5 mm stroke.

Foot style: CQSYL/CDQSYL

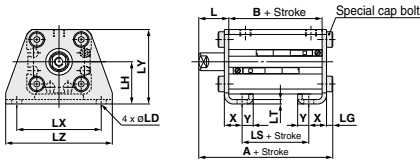

Rod end male thread

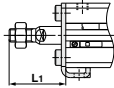

Compact foot style: CQSYLC/CDQSYLC

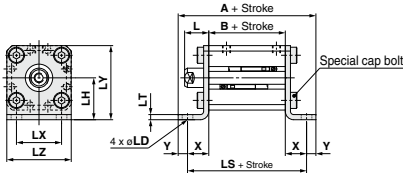

Rod end male thread

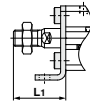

Rod side flange style: CQSYF/CDQSYF

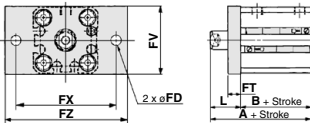

Rod end male thread

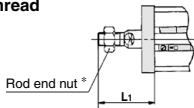

Head side flange style: CQSYG/CDQSYG

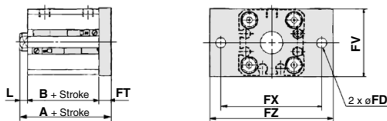

Rod end male thread

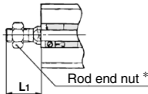

Foot Style

Bore size (mm)	Stroke range (mm)	Without auto switch			With auto switch		
		A	B	LS	A	B	LS
12	5 to 30	40.3	22	10	45.3	27	15
16	5 to 30	40.3	22	10	45.3	27	15
20	5 to 50	46.2	24.5	12.5	56.2	34.5	22.5
25	5 to 50	49.7	27.5	12.5	59.7	37.5	22.5

Bore size (mm)	L	L ₁	LD	LG	LH	LT	LX	LY	LZ	X	Y
12	13.5	24	4.5	2.8	17	2	34	29.5	44	8	4.5
16	13.5	25.5	4.5	2.8	19	2	38	33.5	48	8	5
20	14.5	28.5	6.6	4	24	3.2	48	42	62	9.2	5.8
25	15	32.5	6.6	4	26	3.2	52	46	66	10.7	5.8

Foot bracket material: Carbon steel
Surface treatment: Nickel plated

Compact Foot Style

Bore size (mm)	Stroke range (mm)	Without auto switch			With auto switch		
		A	B	LS	A	B	LS
12	5 to 30	49.6	22	40.6	54.6	27	45.6
16	5 to 30	50.6	22	40.6	55.6	27	45.6
20	5 to 50	62.5	24.5	50.9	72.5	34.5	60.9
25	5 to 50	65.5	27.5	53.9	75.5	37.5	63.9

Bore size (mm)	L	L ₁	LD	LH	LT	LX	LY	LZ	X	Y
12	13.5	24	4.5	17	2	15.5	29.5	25	9.3	4.5
16	13.5	25.5	4.5	19	2	20	33.5	29	9.3	5
20	14.5	28.5	6.6	24	3.2	25.5	42	36	13.2	5.8
25	15	32.5	6.6	26	3.2	28	46	40	13.2	5.8

Compact foot bracket material: Carbon steel
Surface treatment: Zinc chromated

Rod Side Flange Style

Bore size (mm)	Stroke range (mm)	Without auto switch		With auto switch	
		A	B	A	B
12	5 to 30	35.5	22	40.5	27
16	5 to 30	35.5	22	40.5	27
20	5 to 50	39	24.5	49	34.5
25	5 to 50	42.5	27.5	52.5	37.5

Bore size (mm)	FD	FT	FV	FX	FZ	L	L ₁
12	4.5	5.5	25	45	55	13.5	24
16	4.5	5.5	30	45	55	13.5	25.5
20	6.6	8	39	48	60	14.5	28.5
25	6.6	8	42	52	64	15	32.5

Flange bracket material: Carbon steel
Surface treatment: Nickel plated

Head Side Flange Style

Bore size (mm)	Stroke range (mm)	Without auto switch		With auto switch	
		A	B	A	B
12	5 to 30	31	22	36	27
16	5 to 30	31	22	36	27
20	5 to 50	37	24.5	47	34.5
25	5 to 50	40.5	27.5	50.5	37.5

Bore size (mm)	FD	FT	FV	FX	FZ	L	L ₁
12	4.5	5.5	25	45	55	3.5	14
16	4.5	5.5	30	45	55	3.5	15.5
20	6.6	8	39	48	60	4.5	18.5
25	6.6	8	42	52	64	5	22.5

Flange bracket material: Carbon steel
Surface treatment: Nickel plated

* For details about the rod end nut and accessory brackets, refer to page 1274.

Double clevis style: CQSYD/CDQSYD

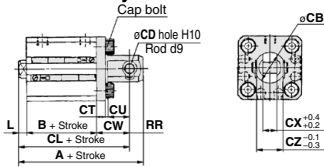

Rod end male thread

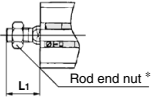

Double Clevis Style

Bore size (mm)	Stroke range (mm)	Without auto switch			With auto switch		
		A	B	CL	A	B	CL
12	5 to 30	45.5	22	39.5	50.5	27	44.5
16	5 to 30	46.5	22	40.5	51.5	27	45.5
20	5 to 50	56	24.5	47	66	34.5	57
25	5 to 50	62.5	27.5	52.5	72.5	37.5	62.5

Bore size (mm)	CB	CD	CT	CU	CW	CX	CZ	L	L ₁	RR
12	12	5	4	7	14	5	10	3.5	14	6
16	14	5	4	10	15	6.5	12	3.5	15.5	6
20	20	8	5	12	18	8	16	4.5	18.5	9
25	24	10	5	14	20	10	20	5	22.5	10

Double clevis bracket material: Carbon steel
Surface treatment: Nickel plated

* For details about the rod end nut and accessory brackets, refer to page 1274.

- REA
- REB
- REC
- CQY**
- CQX
- MQ
- RHC
- RZQ

- D-□
- X□

Series CQSY Auto Switch Mounting

Minimum Auto Switch Mounting Stroke

Number of auto switches	(mm)						
	D-M9□V	D-A9□V	D-M9□WV D-M9□AV	D-A9□	D-M9□W D-M9□A	D-M9□	D-P3DW□ ^{Note 1)}
1 pc.	5	5	10	10 (5)	15 (10)	15 (5)	15
2 pcs.	5	10	10	10	15 (10)	15 (5)	15

Note 1) ø25 is only applicable for D-P3DW□.

Note 2) The dimensions stated in () shows the minimum stroke for the auto switch mounting when the auto switch does not project from the end surface of the cylinder body and hinder the lead wire bending space. (Refer to the figure on the right.)

Order auto switches separately.



Auto Switch Proper Mounting Position (Detection at Stroke End) and Its Mounting Height

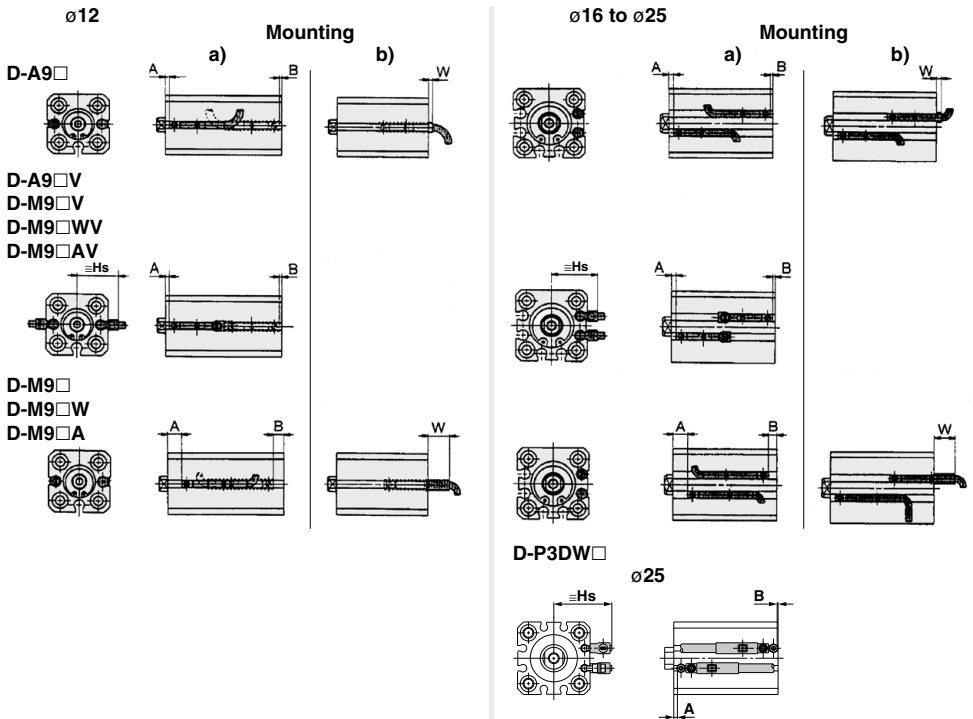

Auto Switch Proper Mounting Position

Auto switch model	D-A9□						D-A9□V			D-M9□/M9□W			D-M9□A			D-M9□V/M9□WV D-M9□AV			D-P3DW□		
	A	B	W	A	B	Hs	A	B	W	A	B	W	A	B	Hs	A	B	Hs			
12	1.5	0	1.5 [4] [5]	1.5	0	17	5.5	3.5	5.5	5.5	3.5	7.5	5.5	3.5	19.5	—	—	—			
16	2	0	2 [4.5]	2	0	19	6	4	6	6	4	8	6	4	21.5	—	—	—			
20	6	3.5	-1.5 [1]	6	3.5	22.5	10	7.5	2.5	10	7.5	4.5	10	7.5	25	—	—	—			
25	7	5.5	-3.5 [-1]	7	5.5	24.5	11	9.5	0.5	11	9.5	2.5	11	9.5	27	1.5	0	32			

Note 1) [] : Denotes the values of D-A93.

Note 2) Adjust the auto switch after confirming the operating conditions in the actual setting.

Note 3) The product is shipped out of the factory in installation state "a)". To change the electrical entry direction of the switch on the head, refer to installation state "b)".

Note 4) Negative figures for W indicate an auto switch is mounted inward from the edge of the cylinder body.

Operating Range

Auto switch model	(mm)			
	Bore size (mm)			
	12	16	20	25
D-A9□/A9□V	6	7.5	10	10
D-M9□/M9□V	3	3.5	5.5	4.5
D-M9□W/M9□WV				
D-M9□A/M9□AV				
D-P3DW	—	—	—	5.5

* Since this is a guideline including hysteresis, not meant to be guaranteed.
 (assuming approximately ±30% dispersion.)
 There may be the case it will vary substantially depending on an ambient environment.

Besides the models listed in How to Order, the following auto switches are applicable.
 * For solid state auto switches, auto switches with a pre-wired connector are also available. Refer to pages 1960 and 1961 for details.
 * Normally closed (NC = b contact), solid state auto switch (D-F9G/F9H type) are also available. For details, refer to page 1911.

⚠ Precautions

Be sure to read before handling.
Refer to front matter 39 for Safety Instructions and pages 3 to 12 for Actuator and Auto Switch Precautions.

• If the cylinder is used in an application in which a magnetic material is placed in close contact around the cylinder as shown in the graph on the right (including cases in which even one of the sides is in close contact) the operation of auto switches could become unstable. Therefore, please check with SMC for this type of application.

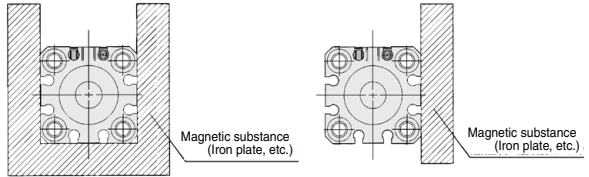

- REA
- REB
- REC
- C□Y
- C□X
- MQ
- RHC
- RZQ

- D-□
- X□

Smooth Cylinder

Series CQ2Y

∅32, ∅40, ∅50, ∅63, ∅80, ∅100

How to Order

With auto switch **CDQ2Y** **B** **32** **—** **30** **D** **C** **—** **Z** **—** **M9BW** **—**

With auto switch
(Built-in magnet)

Mounting style

B	Through-hole (Standard)
A	Both ends tapped
L	Foot style <small>(Note)</small>
LC	Compact foot style
F	Rod side flange style
G	Head side flange style
D	Double clevis style

Bore size

32	32 mm
40	40 mm
50	50 mm
63	63 mm
80	80 mm
100	100 mm

Thread type

Nil	Rc
TN	NPT
TF	G

Cylinder stroke (mm)
Refer to "Standard Stroke" on page 1177.

Action

D	Double acting
----------	---------------

Cushion

C	Rubber bumper
----------	---------------

Number of auto switches

Nil	2 pcs.
S	1 pc.
n	n pcs.

Auto switch

Nil	Without auto switch
------------	---------------------

* For the applicable auto switch model, refer to the table below.

Auto switch mounting groove

Z	4 surfaces
----------	------------

Body option

Nil	Standard (Rod end female thread)
M	Rod end male thread

Built-in Magnet Cylinder Model

If a built-in magnet cylinder without an auto switch is required, there is no need to enter the symbol for the auto switch.
(Example) CDQ2YL40-50DCZ

Refer to pages 1893 to 2007 for further information on auto switches.
For D-P3DW, refer to pages 1948 and 1949.

Applicable Auto Switches/

Type	Special function	Electrical entry	Indicator/light	Wiring (Output)	Load voltage		Auto switch model		Lead wire (m)					Pre-wired connector	Applicable load			
					DC	AC	Perpendicular	In-line	0.5 (Nil)	1 (M)	3 (L)	5 (Z)	None (N)					
									—	—	●	●				●	○	—
Solid state auto switch	—	Grommet	Yes	3-wire (NPN)	24 V	5 V, 12 V	—	M9NV	M9N	●	●	●	○	—	○	IC circuit		
				3-wire (PNP)				M9PV	M9P	●	●	●	○	—	○			
				2-wire				M9BV	M9B	●	●	●	○	—	○			
				3-wire (NPN)				M9NW	M9W	●	●	●	○	—	○			
	Diagnostic indication (2-color indication)			3-wire (PNP)				12 V	M9PW	M9PW	●	●	●	○	—		○	IC circuit
				2-wire				12 V	M9BW	M9BW	●	●	●	○	—		○	—
				3-wire (NPN)				5 V, 12 V	M9NAV**	M9NA**	○	○	●	○	—		○	IC circuit
				3-wire (PNP)				12 V	M9PAV**	M9PA**	○	○	●	○	—		○	IC circuit
Water resistant (2-color indication)	2-wire	12 V	M9BAV**	M9BA**	○	○	○	○	—	○	—							
	2-wire (Non-polar)	—	—	P3DW	●	—	●	—	—	—	—							
	Magnetic field resistant (2-color indication)	3-wire (NPN equivalent)	—	5 V	—	A96V	A96	●	—	●	—	—	IC circuit	—				
		2-wire	24 V	12 V	100 V	A93V	A93	●	—	●	—	—	—	Relay, PLC				
Read auto switch	—	Grommet	No	3-wire (NPN equivalent)	24 V	5 V, 12 V	100 V or less	A90V	A90	●	—	●	—	—	IC circuit	—		
						—	—	—	—	—	—	—	—	—	—	—	IC circuit	—

** Water resistant type auto switches can be mounted on the above models, but in such case SMC cannot guarantee water resistance. Consult with SMC regarding water resistant types with the above model numbers.

* Lead wire length symbols: 0.5 m Nil (Example) M9NW * ○: Manufactured upon receipt of order.

1 m M (Example) M9NWM
3 m L (Example) M9NWL
5 m Z (Example) M9NWZ

* In addition to the models in the above table, there are some other auto switches that are applicable. For more information, refer to page 1188.

* Refer to pages 1960 and 1961 for details of auto switches with a pre-wired connector.

Specifications



Symbol
Rubber bumper

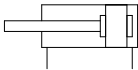

Bore size (mm)	32	40	50	63	80	100
Type	Pneumatic (Non-lube)					
Fluid	Air					
Proof pressure	1.05 MPa					
Maximum operating pressure	0.7 MPa					
Ambient and fluid temperature	Without auto switch -10 to 70°C (with no freezing)					
	With auto switch -10 to 60°C (with no freezing)					
Cushion	Rubber bumper (Standard)					
Stroke length tolerance	+1.0 mm (Note) 0					
Operating piston speed range	5 to 500 mm/s					
Allowable leakage rate	0.5 L/min (ANR) or less					

(Note) Stroke length tolerance does not include the amount of bumper change.

Minimum Operating Pressure

Bore size (mm)	32	40	50	63	80	100
Minimum operating pressure	0.02			0.01		

Unit: MPa

Standard Stroke

Bore size (mm)	Standard stroke (mm)
32, 40	5, 10, 15, 20, 25, 30, 35, 40, 45, 50, 75, 100
50, 63, 80, 100	10, 15, 20, 25, 30, 35, 40, 45, 50, 75, 100

Replacement Parts: Seal Kit

Bore size (mm)	Kit no.	Contents
32	CQ2Y32-PS	
40	CQ2Y40-PS	Piston seal 1 pc.
50	CQ2Y50-PS	Rod seal 1 pc.
63	CQ2Y63-PS	Gasket 1 pc.
80	CQ2Y80-PS	Grease pack (10 g) 1 pc.
100	CQ2Y100-PS	

When only grease for maintenance is necessary, please order by the following part numbers.

Grease pack part no.: GR-L-005 (5 g)
GR-L-010 (10 g)
GR-L-150 (150 g)

Theoretical Output

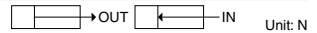

Bore size (mm)	Operating direction	Operating pressure (MPa)		
		0.3	0.5	0.7
32	IN	181	302	422
	OUT	241	402	563
40	IN	317	528	739
	OUT	377	628	880
50	IN	495	825	1155
	OUT	589	982	1374
63	IN	841	1402	1962
	OUT	935	1559	2182
80	IN	1361	2268	3175
	OUT	1508	2513	3519
100	IN	2144	3574	5003
	OUT	2356	3927	5498

Intermediate Stroke

Method	Installation of spacer on standard stroke body.				
Model no.	Refer to page 1176 for standard model no.				
Standard stroke	Method	Intermediate strokes at 1 mm intervals are available by using spacers with standard stroke cylinders.			
	Stroke range	<table border="1"> <thead> <tr> <th>Bore size (mm)</th> <th>Stroke range (mm)</th> </tr> </thead> <tbody> <tr> <td>32 to 100</td> <td>1 to 99</td> </tr> </tbody> </table>	Bore size (mm)	Stroke range (mm)	32 to 100
Bore size (mm)	Stroke range (mm)				
32 to 100	1 to 99				
Example	Part no.: CQ2YB50-57DCZ CQ2YB50-75DCZ with 18 mm width spacer inside. B dimension is 125.5 mm. Calculation: $\phi 50, B \text{ dimension } 50.5 \text{ mm (without switch)}$ $50.5 (B \text{ dimension}) + 75 (st) = 125.5 (mm)$				

REA

REB

REC

COY

COX

MQ

RHC

RZQ

D-□

-X□

Series CQ2Y

Mounting Bolt

Mounting method: Mounting bolt for through-hole mounting style of CQ2YB is available as an option.

Refer to the following for ordering procedures. Order the actual number of bolts that will be used.

Example) CQ-M5x40L 2 pcs.

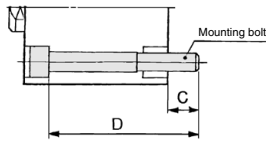

Mounting Bolt for CQ2YB without Auto Switch

Cylinder model	C	D	Mounting bolt part no.
CQ2YB32- 5DC	9	40	CQ-M5 x 40L
- 10DC		45	x 45L
- 15DC		50	x 50L
- 20DC		55	x 55L
- 25DC		60	x 60L
- 30DC		65	x 65L
- 35DC		70	x 70L
- 40DC		75	x 75L
- 45DC		80	x 80L
- 50DC		85	x 85L
- 75DC		120	x 120L
-100DC		145	x 145L
CQ2YB40- 5DC	7.5	45	CQ-M5x 45L
- 10DC		50	x 50L
- 15DC		55	x 55L
- 20DC		60	x 60L
- 25DC		65	x 65L
- 30DC		70	x 70L
- 35DC		75	x 75L
- 40DC		80	x 80L
- 45DC		85	x 85L
- 50DC		90	x 90L
- 75DC		125	x 125L
-100DC		150	x 150L
CQ2YB50- 10DC	12.5	55	CQ-M6 x 55L
- 15DC		60	x 60L
- 20DC		65	x 65L
- 25DC		70	x 70L
- 30DC		75	x 75L
- 35DC		80	x 80L
- 40DC		85	x 85L
- 45DC		90	x 90L
- 50DC		95	x 95L
- 75DC		130	x 130L
-100DC			155

Cylinder model	C	D	Mounting bolt part no.
CQ2YB63- 10DC	14.5	60	CQ-M8 x 60L
- 15DC		65	x 65L
- 20DC		70	x 70L
- 25DC		75	x 75L
- 30DC		80	x 80L
- 35DC		85	x 85L
- 40DC		90	x 90L
- 45DC		95	x 95L
- 50DC		100	x 100L
- 75DC		135	x 135L
-100DC			160
CQ2YB80- 10DC	15	65	CQ-M10 x 65L
- 15DC		70	x 70L
- 20DC		75	x 75L
- 25DC		80	x 80L
- 30DC		85	x 85L
- 35DC		90	x 90L
- 40DC		95	x 95L
- 45DC		100	x 100L
- 50DC		105	x 105L
- 75DC		140	x 140L
-100DC			165
CQ2YB100- 10DC	15.5	75	CQ-M10 x 75L
- 15DC		80	x 80L
- 20DC		85	x 85L
- 25DC		90	x 90L
- 30DC		95	x 95L
- 35DC		100	x100L
- 40DC		105	x 105L
- 45DC		110	x 110L
- 50DC		115	x 115L
- 75DC		150	x 150L
-100DC			175

Material: Chromium molybdenum steel
Surface treatment: Zinc chromated

Mounting Bolt for CDQ2YB with Auto Switch (Built-in Magnet)

Cylinder model	C	D	Mounting bolt part no.
CDQ2YB32-	5	50	CQ-M5 x 50L
- 10		55	x 55L
- 15		60	x 60L
- 20		65	x 65L
- 25		70	x 70L
- 30		75	x 75L
- 35		80	x 80L
- 40		85	x 85L
- 45		90	x 90L
- 50		95	x 95L
- 75		120	x 120L
-100		145	x 145L
CDQ2YB40-	5	55	CQ-M5 x 55L
- 10		60	x 60L
- 15		65	x 65L
- 20		70	x 70L
- 25		75	x 75L
- 30		80	x 80L
- 35		85	x 85L
- 40		90	x 90L
- 45		95	x 95L
- 50		100	x 100L
- 75		125	x 125L
-100		150	x 150L
CDQ2YB50-	10	65	CQ-M6 x 65L
- 15		70	x 70L
- 20		75	x 75L
- 25		80	x 80L
- 30		85	x 85L
- 35		90	x 90L
- 40		95	x 95L
- 45		100	x 100L
- 50		105	x 105L
- 75		130	x 130L
-100		155	x 155L

Cylinder model	C	D	Mounting bolt part no.
CDQ2YB63-	10	70	CQ-M8 x 70L
- 15		75	x 75L
- 20		80	x 80L
- 25		85	x 85L
- 30		90	x 90L
- 35		95	x 95L
- 40		100	x 100L
- 45		105	x 105L
- 50		110	x 110L
- 75		135	x 135L
-100		160	x 160L
CDQ2YB80-		10	75
- 15	80		x 80L
- 20	85		x 85L
- 25	90		x 90L
- 30	95		x 95L
- 35	100		x 100L
- 40	105		x 105L
- 45	110		x 110L
- 50	115		x 115L
- 75	140		x 140L
-100	165		x 165L
CDQ2YB100-	10		85
- 15		90	x 90L
- 20		95	x 95L
- 25		100	x 100L
- 30		105	x 105L
- 35		110	x 110L
- 40		115	x 115L
- 45		120	x 120L
- 50		125	x 125L
- 75		150	x 150L
-100		175	x 175L

Material: Chromium molybdenum steel
Surface treatment: Zinc chromated

- REA**
- REB**
- REC**
- Y**
- X**
- MQ**
- RHC**
- RZQ**

- D-**
- X**

Series CQ2Y

ø32 to ø50

(Types with auto switch and without auto switch only differ in the A and B dimensions. Please refer to the table below.)

Through-hole: CQ2YB/CDQ2YB

Both ends tapped style: CQ2YA/CDQ2YA

CDQ2YA

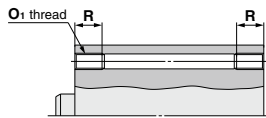

Both Ends Tapped (mm)

Bore size (mm)	O1	R
32	M6 x 1.0	10
40	M6 x 1.0	10
50	M8 x 1.25	14

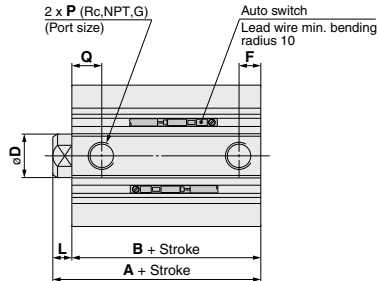
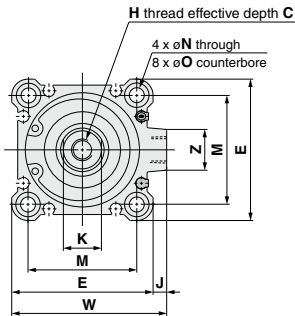

Rod end male thread

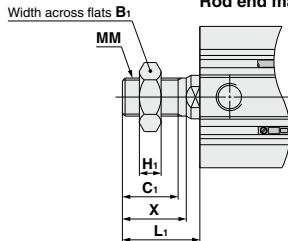

Rod End Male Thread (mm)

Bore size (mm)	B1	C1	H1	L1	MM	X
32	22	20.5	8	28.5	M14 x 1.5	23.5
40	22	20.5	8	28.5	M14 x 1.5	23.5
50	27	26	11	33.5	M18 x 1.5	28.5

Bore size (mm)	Stroke range (mm)	Without auto switch		With auto switch		C	D	E	F	H	J	K	L	M	N	O	P	Q	W	Z
		A	B	A	B															
32	5 to 50	40	33	50	43	13	16	45	7.5	M8 x 1.25	4.5	14	7	34	5.5	9 depth 7	1/8	10	49.5	14
	75, 100	50	43																	
40	5 to 50	46.5	39.5	56.5	49.5	13	16	52	7.5	M8 x 1.25	5	14	7	40	5.5	9 depth 7	1/8	12.5	57	14
	75, 100	56.5	49.5																	
50	10 to 50	48.5	40.5	58.5	50.5	15	20	64	10.5	M10 x 1.5	7	17	8	50	6.6	11 depth 8	1/4	10.5	71	19
	75, 100	58.5	50.5																	

Foot style: CQ2YL/CDQ2YL

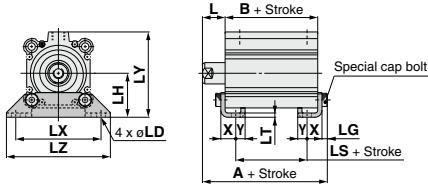

Rod end male thread

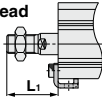

Compact foot style: CQ2YLC/CDQ2YLC

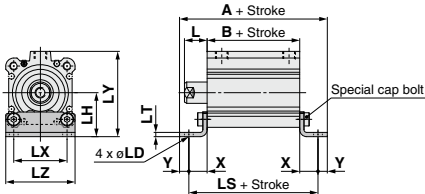

Rod end male thread

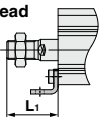

Rod side flange style: CQ2YF/CDQ2YF

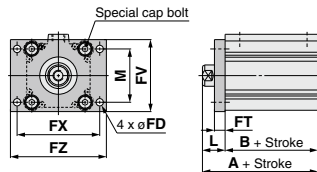

Rod side flange style: CQ2YF/CDQ2YF

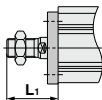

Head side flange style: CQ2YG/CDQ2YG

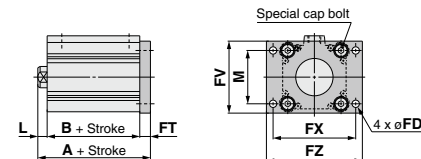

Foot Style

Bore size (mm)	Stroke range (mm)	Without auto switch			With auto switch			L	L ₁	LD
		A	B	LS	A	B	LS			
32	5 to 50	57.2	33	17	67.2	43	27	17	38.5	6.6
	75, 100	67.2	43	27						
40	5 to 50	63.7	39.5	23.5	73.7	49.5	33.5	17	38.5	6.6
	75, 100	73.7	49.5	33.5						
50	10 to 50	66.7	40.5	17.5	76.7	50.5	27.5	18	43.5	9
	75, 100	76.7	50.5	27.5						

Foot bracket material: Carbon steel
Surface treatment: Nickel plated

Compact Foot Style

Bore size (mm)	Stroke range (mm)	Without auto switch			With auto switch			L	L ₁	LD
		A	B	LS	A	B	LS			
32	5 to 50	72	33	60.4	82	43	70.4	17	38.5	6.6
	75, 100	82	43	70.4						
40	5 to 50	80.9	39.5	66.9	90.9	49.5	76.9	17	38.5	6.6
	75, 100	90.9	49.5	76.9						
50	10 to 50	89.9	40.5	73.9	99.9	50.5	83.9	18	43.5	9
	75, 100	99.9	50.5	83.9						

Compact foot bracket material: Carbon steel
Surface treatment: Zinc chromated

Rod Side Flange Style

Bore size (mm)	Stroke range (mm)	Without auto switch			With auto switch		FD	FT	FV	FX	FZ
		A	B	A	B						
32	5 to 50	50	33	60	43	5.5	8	48	56	65	
	75, 100	60	43								
40	5 to 50	56.5	39.5	66.5	49.5	5.5	8	54	62	72	
	75, 100	66.5	49.5								
50	10 to 50	58.5	40.5	68.5	50.5	6.6	9	67	76	89	
	75, 100	68.5	50.5								

Flange bracket material: Carbon steel
Surface treatment: Nickel plated

Head Side Flange Style

Bore size (mm)	Stroke range (mm)	Without auto switch		With auto switch		L	L ₁
		A	A	A	A		
32	5 to 50	48	58	58	7	28.5	
	75, 100	58					
40	5 to 50	54.5	64.5	64.5	7	28.5	
	75, 100	64.5					
50	10 to 50	57.5	67.5	67.5	8	33.5	
	75, 100	67.5					

(* Dimensions except A, L) Flange bracket material: Carbon steel
Surface treatment: Nickel plated
(* Dimensions except A, L₁ are the same as rod side flange style.)

* For details about the rod end nut and accessory brackets, refer to page 1274.

- REA
- REB
- REC
- CQY
- CQX
- MQ
- RHC
- RZQ

- D-□
- X□

Double clevis style: CQ2YD/CDQ2YD

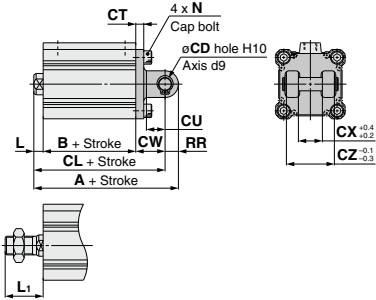

Double Clevis Style

(mm)

Bore size (mm)	Stroke range (mm)	Without auto switch			With auto switch			CD	CT	CU
		A	B	CL	A	B	CL			
32	5 to 50	70	33	60	80	43	70	10	5	14
	75, 100	80	43	70						
40	5 to 50	78.5	39.5	68.5	88.5	49.5	78.5	10	6	14
	75, 100	88.5	49.5	78.5						
50	10 to 50	90.5	40.5	76.5	100.5	50.5	86.5	14	7	20
	75, 100	100.5	50.5	86.5						

Bore size (mm)	Stroke range (mm)	CW	CX	CZ	L	L ₁	N	RR
32	5 to 50	20	18	36	7	28.5	M6 x 1.0	10
	75, 100							
40	5 to 50	22	18	36	7	28.5	M6 x 1.0	10
	75, 100							
50	10 to 50	28	22	44	8	33.5	M8 x 1.25	14
	75, 100							

Double clevis bracket material: Cast iron
Surface treatment: Painted

- * For details about the rod end nut and accessory brackets, refer to page 1274.
- * Double clevis pins and retaining rings are included.

- REA
- REB
- REC
- CQY**
- CQX
- MQ
- RHC
- RZQ

- D-□
- X□

Series CQ2Y

ø63 to ø100

(Types with auto switch and without auto switch only differ in the A and B dimensions. Please refer to the table below.)

Through-hole: CQ2YB/CDQ2YB

Both ends tapped style: CQ2YA/CDQ2YA

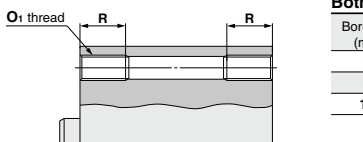

Both Ends Tapped (mm)

Bore size (mm)	O ₁	R
63	M10 x 1.5	18
80	M12 x 1.75	22
100	M12 x 1.75	22

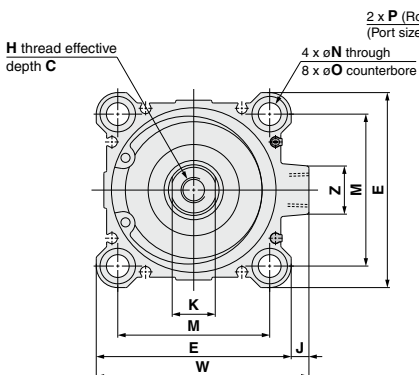

2 x P (Rc,NPT,G)
(Port size)

Lead wire min. bending
radius 10

Auto switch

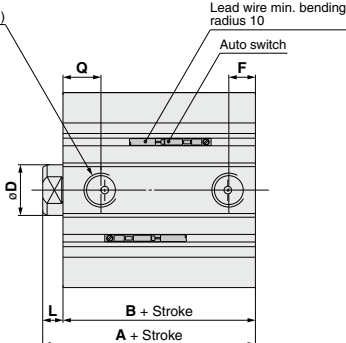

Rod end male thread

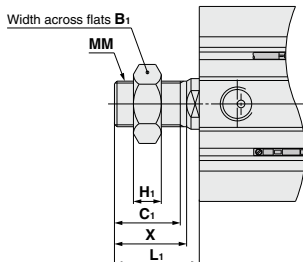

Rod End Male Thread (mm)

Bore size (mm)	B ₁	C ₁	H ₁	L ₁	MM	X
63	27	26	11	33.5	M18 x 1.5	28.5
80	32	32.5	13	43.5	M22 x 1.5	35.5
100	41	32.5	16	43.5	M26 x 1.5	35.5

Bore size (mm)	Stroke range (mm)	Without auto switch		With auto switch		C	D	E	F	H	J	K	L	M	N	O	P	Q	W	Z
		A	B	A	B															
63	10 to 50	54	46	64	56	15	20	77	10.5	M10 x 1.5	7	17	8	60	9	14 depth 10.5	1/4	15	84	19
	75, 100	64	56																	
80	10 to 50	63.5	53.5	73.5	63.5	21	25	98	12.5	M16 x 2.0	6	22	10	77	11	17.5 depth 13.5	3/8	16	104	25
	75, 100	73.5	63.5																	
100	10 to 50	75	63	85	73	27	30	117	13	M20 x 2.5	6.5	27	12	94	11	17.5 depth 13.5	3/8	23	123.5	25
	75, 100	85	73																	

Foot style: CQ2YL/CDQ2YL

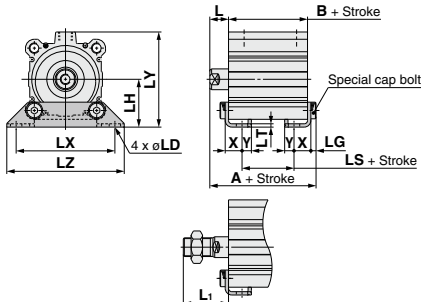

Compact foot style: CQ2YLC/CDQ2YLC

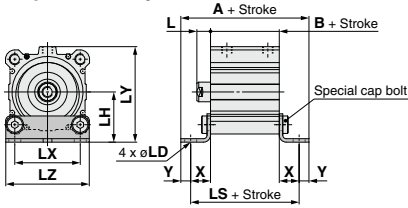

Rod end male thread

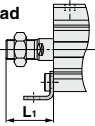

Rod side flange style: CQ2YF/CDQ2YF

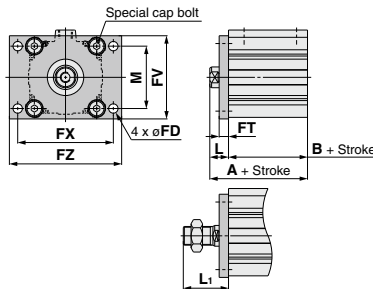

Head side flange style: CQ2YG/CDQ2YG

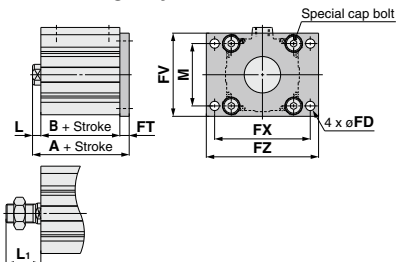

Foot Style

Bore size (mm)	Stroke range (mm)	Without auto switch			With auto switch			L	L ₁	LD
		A	B	LS	A	B	LS			
63	10 to 50	72.2	46	20	82.2	56	30	18	43.5	11
	75, 100	82.2	56	30	95	63.5	33.5	20	53.5	13
80	10 to 50	85	53.5	23.5	95	63.5	33.5	20	53.5	13
	75, 100	95	63.5	33.5	108	73	39	22	53.5	13
100	10 to 50	98	63	29	108	73	39	22	53.5	13
	75, 100	108	73	39	137	136	162	23	12.5	

Foot bracket material: Carbon steel
Surface treatment: Nickel plated

Compact Foot Style

Bore size (mm)	Stroke range (mm)	Without auto switch			With auto switch			L	L ₁	LD
		A	B	LS	A	B	LS			
63	10 to 50	100.4	46	82.4	110.4	56	92.4	18	43.5	11
	75, 100	110.4	56	92.4	130.5	63.5	108.5	20	53.5	13
80	10 to 50	120.5	53.5	98.5	130.5	63.5	108.5	20	53.5	13
	75, 100	130.5	63.5	108.5	146	73	121	22	53.5	13
100	10 to 50	136	63	111	146	73	121	22	53.5	13
	75, 100	146	73	121	162	136	162	23	12.5	

Compact foot bracket material: Carbon steel
Surface treatment: Zinc chromated

Rod Side Flange Style

Bore size (mm)	Stroke range (mm)	Without auto switch		With auto switch		FD	FT	FV	FX	FZ
		A	B	A	B					
63	10 to 50	64	46	74	56	9	9	80	92	108
	75, 100	74	56	83.5	63.5	11	11	99	116	134
80	10 to 50	73.5	53.5	85	63	95	73	111	117	136
	75, 100	83.5	63.5	95	73	111	117	136	154	
100	10 to 50	85	63	95	73	111	117	136	154	
	75, 100	95	73	117	94					

Flange bracket material: Carbon steel
Surface treatment: Nickel plated

Head Side Flange Style

Bore size (mm)	Stroke range (mm)	Without auto switch		With auto switch		L	L ₁
		A	B	A	B		
63	10 to 50	63	46	73	56	8	33.5
	75, 100	73	56	84.5	63.5	10	43.5
80	10 to 50	74.5	53.5	84.5	63.5	10	43.5
	75, 100	84.5	63.5	96	73	12	43.5
100	10 to 50	86	63	96	73	12	43.5
	75, 100	96	73	117	94		

(* Dimensions except A, L₁ are the same as rod side flange style.)
Flange bracket material: Carbon steel
Surface treatment: Nickel plated

* For details about the rod end nut and accessory brackets, refer to page 1274.

Double clevis style: CQ2YD/CDQ2YD

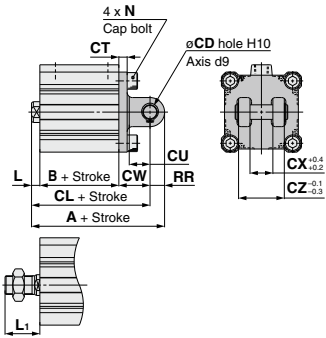

Double Clevis Style

(mm)

Bore size (mm)	Stroke range (mm)	Without auto switch			With auto switch			CD	CT	CU
		A	B	CL	A	B	CL			
63	10 to 50	98	46	84	108	56	94	14	8	20
	75, 100	108	56	94						
80	10 to 50	119.5	53.5	101.5	129.5	63.5	111.5	18	10	27
	75, 100	129.5	63.5	111.5						
100	10 to 50	142	63	120	152	73	130	22	13	31
	75, 100	152	73	130						

Bore size (mm)	Stroke range (mm)	CW	CX	CZ	L	L1	N	RR
63	10 to 50	30	22	44	8	33.5	M10 x 1.5	14
	75, 100							
80	10 to 50	38	28	56	10	43.5	M12 x 1.75	18
	75, 100							
100	10 to 50	45	32	64	12	43.5	M12 x 1.75	22
	75, 100							

Double clevis bracket material: Cast iron
Surface treatment: Painted

- * For details about the rod end nut and accessory brackets, refer to page 1274.
- * Double clevis pins and retaining rings are included.

REA

REB

REC

CQY

CQX

MQ

RHC

RZQ

D-□

-X□

Series CQ2Y

Weight

Weight/Without Auto Switch

Bore size (mm)	Cylinder stroke (mm)											
	5	10	15	20	25	30	35	40	45	50	75	100
32	134	154	174	193	213	233	252	272	291	311	457	556
40	211	232	254	275	297	318	340	361	383	404	577	689
50	—	369	402	435	467	500	533	566	598	632	902	1073
63	—	557	595	633	671	709	747	786	824	862	1189	1386
80	—	983	1043	1104	1164	1224	1284	1345	1405	1465	1985	2281
100	—	1711	1792	1872	1952	2033	2113	2194	2274	2354	3086	3494

Additional Weight

Bore size (mm)		32	40	50	63	80	100
Both ends tapped style		6	6	6	19	45	45
Rod end male thread	Male thread	26	27	53	53	120	175
	Nut	17	17	32	32	49	116
Foot style (Including mounting bolt)		142	154	243	320	690	1057
Compact foot style (Including mounting bolt)		84	98	152	216	462	714
Rod side flange style (Including mounting bolt)		180	214	373	559	1056	1365
Head side flange style (Including mounting bolt)		165	198	348	534	1017	1309
Double clevis style (Including pin, retaining ring, mounting bolt)		151	196	393	554	1109	1887

Calculation: (Example) **CQ2DS32-20DCMZ**

• Basic weight: CQ2BS32-20DCZ.....193 g

• Additional weight: Both ends tapped style.....6 g

Rod end male thread.....43 g

Double clevis style.....151 g

393 g

Weight/With Auto Switch (Built-in magnet)

Bore size (mm)	Cylinder stroke											
	5	10	15	20	25	30	35	40	45	50	75	100
32	191	211	230	250	270	289	309	329	348	368	468	567
40	284	305	327	348	369	391	412	434	455	477	589	701
50	—	480	513	546	579	611	644	677	710	743	915	1087
63	—	710	748	787	825	863	901	939	977	1015	1211	1408
80	—	1229	1289	1350	1410	1470	1530	1591	1651	1711	2008	2305
100	—	2070	2150	2231	2311	2391	2472	2552	2633	2713	3121	3529

Additional Weight

Bore size (mm)		32	40	50	63	80	100
Both ends tapped style		6	6	6	19	45	45
Rod end male thread	Male thread	26	27	53	53	120	175
	Nut	17	17	32	32	49	116
Foot style (Including mounting bolt)		142	154	243	320	690	1057
Compact foot style (Including mounting bolt)		84	98	152	216	462	714
Rod side flange style (Including mounting bolt)		180	214	373	559	1056	1365
Head side flange style (Including mounting bolt)		165	198	348	534	1017	1309
Double clevis style (Including pin, retaining ring, mounting bolt)		151	196	393	554	1109	1887

Calculation: (Example) **CQ2DS32-20DCMZ**

• Basic weight: CQ2BS32-20DCZ.....250 g

• Additional weight: Both ends tapped style.....6 g

Rod end male thread.....43 g

Double clevis style.....151 g

450 g

Add each weight of auto switches when auto switches are mounted.

Series CQ2Y

Auto Switch Mounting 1

Auto Switch Proper Mounting Position (Detection at Stroke End) and Its Mounting Height

- D-A9□
- D-M9□
- D-M9□W
- D-M9□A
- D-A9□V
- D-M9□V
- D-M9□WV
- D-M9□AV

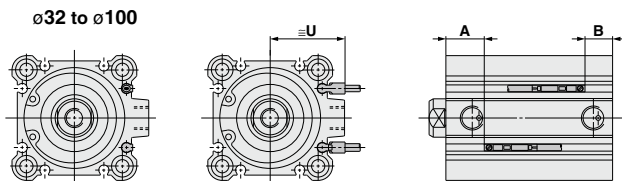

- D-A7□
- D-A80
- D-A7□H
- D-A80H
- D-F7□
- D-J79
- D-F7□W
- D-J79W
- D-F79F
- D-F7NT
- D-A73C
- D-A80C
- D-J79C
- D-A79W
- D-F7□WV
- D-F7□V

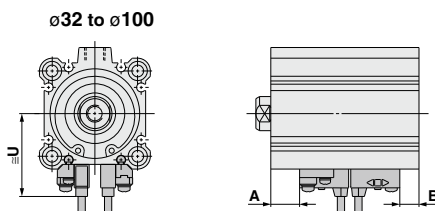

- D-P3DW

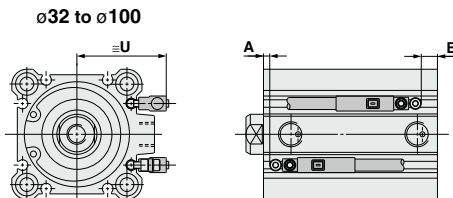

Auto Switch Proper Mounting Position

Auto switch model	Bore size (mm)															
	D-A9□ D-A9□V		D-M9□/D-M9□V D-M9□W D-M9□WV D-M9□A D-M9□AV		D-A73 D-A80		D-A72/A7□H/A80H D-A73C/A80C/F7□ D-F79F/J79/F7□V D-J79C/F7□W D-J79W/F7□WV		D-F7NT		D-A79W		D-P3DW			
Bore size	A	B	A	B	A	B	A	B	A	B	A	B	A	B		
32	14	9	18	13	15	10	15.5	10.5	20.5	15.5	12.5	7.5	8	3.5		
40	17.5	12	21.5	16	18.5	13	19	13.5	24	18.5	16	10.5	11.5	6.5		
50	15	15.5	19	19.5	16	16.5	16.5	17	21.5	22	13.5	14	9.5	9.5		
63	17.5	18.5	21.5	22.5	18.5	19.5	19	20	24	25	16	17	12	12.5		
80	20.5	23	24.5	27	21.5	24	22	24.5	27	29.5	19	21.5	15	17		
100	23.5	29.5	27.5	33.5	24.5	30.5	25	31	30	36	22	28	18	24		

Note) Adjust the auto switch after confirming the operating conditions in the actual setting.

Auto Switch Mounting Height

Auto switch model	Bore size (mm)									
	D-M9□V	D-A9□V	D-F7□/J79 D-F7□W/J79W D-F7BA D-F79F/F7NT D-A7□H/A80H	D-F7□V D-F7□WV	D-J79C	D-A7□ D-A80	D-A73C D-A80C	D-A79W	D-P3DW	
Bore size	U	U	U	U	U	U	U	U	U	
32	30	27.5	36	36.5	39.5	34	40.5	37.5	33	
40	32	30	38	40	42.5	37.5	43.5	40.5	36.5	
50	37.5	35	43.5	45	48	43	49	46	42	
63	42.5	40.5	48.5	50.5	53.5	48	54.5	51.5	47	
80	51	49	57	59	61.5	56.5	62.5	59.5	55.5	
100	59	57	65.5	67	70	64.5	71	68	65.5	

REA

REB

REC

CQY

CQX

MQ

RHC

RZQ

D-□

-X□

Series CQ2Y

Auto Switch Mounting 2

Minimum Auto Switch Mounting Stroke

Number of auto switches	D-M9□V D-F7□V D-J79C	D-A9□V D-A7□ D-A80 D-A73C D-A80C	D-A9□	D-M9□WV D-M9□AV D-F7□WV	D-M9□ D-F7□ D-J79	D-M9□W D-M9□A	D-A7□H D-A80H	D-A79W	D-F7□W D-J79W D-F79F D-F7NT	D-P3DW
	1 pc.	5	5	10 (5)	10	15 (5)	15 (10)	15 (5)	15	20 (10)
2 pcs.	5	10	10	15	15 (5)	15	15 (10)	20	20 (15)	15

(mm)

Note) The dimensions stated in () shows the minimum stroke for the auto switch mounting when the auto switch does not project from the end surface of the cylinder body and hinder the lead wire bending space. (Refer to the figure below.)
Order auto switches and auto switch mounting brackets separately.

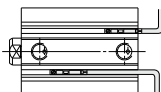

Operating Range

Auto switch model	Bore size (mm)					
	32	40	50	63	80	100
D-A9□(V)	9	9.5	9.5	11	10.5	10.5
D-M9□(V) D-M9□W(V) D-M9□A(V)	5	5	6	6.5	7	7.5
D-A7□(H)(C) D-A80□(H)(C)	10.5	11.5	11	13	11.5	11.5
D-A79W	14	15.5	14.5	17	15	15.5
D-F7□(V) D-J79(C) D-F7□W(V) D-F7NT D-F79F	5	5	5	6	7	8
D-P3DW	3	4.5	4.5	6	5.5	6.5

(mm)

* Since this is a guideline including hysteresis, not meant to be guaranteed. (assuming approximately ±30% dispersion.)

There may be the case it will vary substantially depending on an ambient environment.

* Auto switch mounting brackets BQ2-012 are not used for sizes over ø32 of D-A9□(V)/M9□(V)/M9□W(V)/M9□A(V) types. The above values indicate the operating range when mounted with the conventional auto switch installation groove.

Auto Switch Mounting Brackets/Part No.

Applicable Cylinder Series: CDQ2

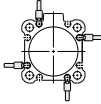
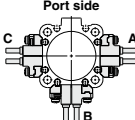
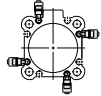
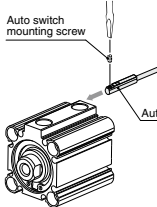
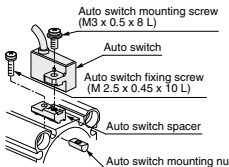
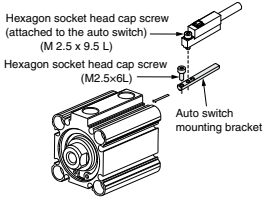
Applicable auto switch	D-M9□/M9□V D-M9□W/M9□WV D-M9□A/M9□AV D-A9□/A9□V	D-F7□/F7□V/J79/J79C/F7□W J79W/F7□WV/D-F7BA/F7BAV F79F/F7NT/D-A7□/A80/A7□H A80H/A73C/A80C/A79W	D-P3DW								
Bore size (mm)	ø32 to ø100										
Auto switch mounting bracket part no.		BQ5-032	BQ6-032S								
Auto switch mounting bracket fitting parts lineup/Weight		<ul style="list-style-type: none"> ● Auto switch fixing screw (M2.5 x 10L) ● Auto switch mounting screw (M3 x 8L) ● Auto switch spacer ● Auto switch mounting nut Weight: 3.5 g	<ul style="list-style-type: none"> ● Hexagon socket head cap screw (M 2.5 x 6L) ● Auto switch mounting bracket (nut) Weight: 5 g								
		When requesting the enclosure of the auto switch mounting brackets (2 pcs.) with the cylinder for shipment, add "BQ" to the end of the cylinder model number. Standard model no. + BQ Example) CDQ2B32-30DZ- BQ									
Auto switch mounting surface	Surfaces with auto switch mounting slot	A/B/C side except port side	Surfaces with auto switch mounting slot								
											
Mounting of auto switch	 <p>● When tightening the auto switch mounting screw, use a watchmakers' screwdriver with a handle 5 to 6 mm in diameter.</p> <p>Tightening torque for auto switch mounting screw (N·m)</p> <table border="1" style="width: 100%; border-collapse: collapse;"> <thead> <tr> <th style="width: 50%;">Auto switch model</th> <th style="width: 50%;">Tightening torque</th> </tr> </thead> <tbody> <tr> <td>D-M9□(V)</td> <td rowspan="3" style="text-align: center;">0.05 to 0.15</td> </tr> <tr> <td>D-M9□W(V)</td> </tr> <tr> <td>D-M9□A(V)</td> </tr> <tr> <td>D-A9□(V)</td> <td style="text-align: center;">0.10 to 0.20</td> </tr> </tbody> </table>	Auto switch model	Tightening torque	D-M9□(V)	0.05 to 0.15	D-M9□W(V)	D-M9□A(V)	D-A9□(V)	0.10 to 0.20	<ol style="list-style-type: none"> ① Insert the nut into the auto switch mounting slot on the cylinder tube, and place it in the roughly estimated setting position. ② With the lower tapered part of the auto switch spacer facing the outside of the cylinder tube, line up the M2.5 through hole with the M2.5 female thread of the auto switch mounting nut. ③ Gently screw the auto switch mounting nut fixing screw (M2.5) into the thread of the auto switch mounting nut through the mounting hole. ④ Engage the ridge on the auto switch mounting arm with the recess in the auto switch spacer. ⑤ Tighten the auto switch mounting screw (M3) to fix the auto switch. The tightening torque of the M3 screw must be 0.35 to 0.45 N·m. ⑥ Confirm where the mounting position is, and tighten the auto switch fixing screw (M2.5) to fix the auto switch mounting nut. The tightening torque of the M2.5 screw must be 0.25 to 0.35 N·m. ⑦ The detection position can be changed under the conditions in step ⑤. 	<ol style="list-style-type: none"> ① Fix the auto switch and the auto switch mounting bracket temporarily by tightening the hexagon socket head cap screw (M2.5 x 9.5L) attached to the auto switch 1 to 2 turns. ② Insert the temporarily tightened mounting bracket into the mating groove of the cylinder tube, and slide the auto switch onto the cylinder tube through the groove. To insert the auto switch onto the cylinder/tube through the groove, first hold the back of the auto switch (lead wire side) and the back of the auto switch mounting bracket together. ③ Check the detecting position of the auto switch and fix the auto switch firmly with the hexagon socket head cap screw (M2.5 x 6L, M2.5 x 9.5L).* ④ If the detecting position is changed, go back to step ②. <ul style="list-style-type: none"> * The hexagon socket head cap screw (M2.5 x 6L) is used to fix the mounting bracket and cylinder tube. This enables the replacement of the auto switch without adjusting the auto switch position. <p>Note 1) Ensure that the auto switch is covered with the mating groove to protect the auto switch.</p> <p>Note 2) The tightening torque of the hexagon socket head cap screw (M2.5 x 6L, M2.5 x 9.5L) must be 0.2 to 0.3 N·m.</p> <p>Note 3) Tighten the hexagon socket head cap screws evenly.</p> 
Auto switch model	Tightening torque										
D-M9□(V)	0.05 to 0.15										
D-M9□W(V)											
D-M9□A(V)											
D-A9□(V)	0.10 to 0.20										

Note) Auto switch mounting bracket and auto switch are enclosed with the cylinder for shipment.
 Auto switch mounting bracket for the D-F7BA(V) type uses BQ5-032 normal specifications (metal screw).

- REA
- REB
- REC
- COY
- CQX
- MQ
- RHC
- RZQ

- D-□
- X□

Series CQ2Y

Auto Switch Mounting 3

Other than the applicable auto switches listed in “How to Order”, the following auto switches can be mounted. For detailed specifications, refer to pages 1893 to 2007.

Auto switch type	Model	Electrical entry (Direction)	Features	Applicable bore size
Reed	D-A72	Grommet (Perpendicular)		ø12 to ø100 ø125 to ø160
	D-A73			
	D-A80		Without indicator light	
	D-A79W		Diagnostic indication (2-color indication)	
	D-A73C	Connector (Perpendicular)		
	D-A80C		Without indicator light	
	D-A72H	Grommet (In-line)		
	D-A73H, A76H			
	D-A80H		Without indicator light	
	D-F7NV, F7PV, F7BV		Grommet (Perpendicular)	
D-F7NWV, F7BWV	Diagnostic indication (2-color indication)			
Solid state	D-F7BAV	Connector (Perpendicular)	Water resistant (2-color indication)	
	D-J79C			
	D-F79, F7P, J79	Grommet (In-line)		
	D-F79W, F7PW, J79W		Diagnostic indication (2-color indication)	
	D-F7BA		Water resistant (2-color indication)	
	D-F79F		With diagnostic output (2-color indication)	
	D-F7NT		With timer	

* With pre-wired connector is available for solid state auto switches. For details, refer to pages 1960 and 1961.

* Normally closed (NC = b contact), solid state auto switches (D-F9G, F9H type) are also available. For details, refer to page 1911.

* Trimmer auto switch (D-F7K) and heat resistant solid state auto switch (D-F7NJ) are not available.

Smooth Cylinder Series CM2Y

ø20, ø25, ø32, ø40

How to Order

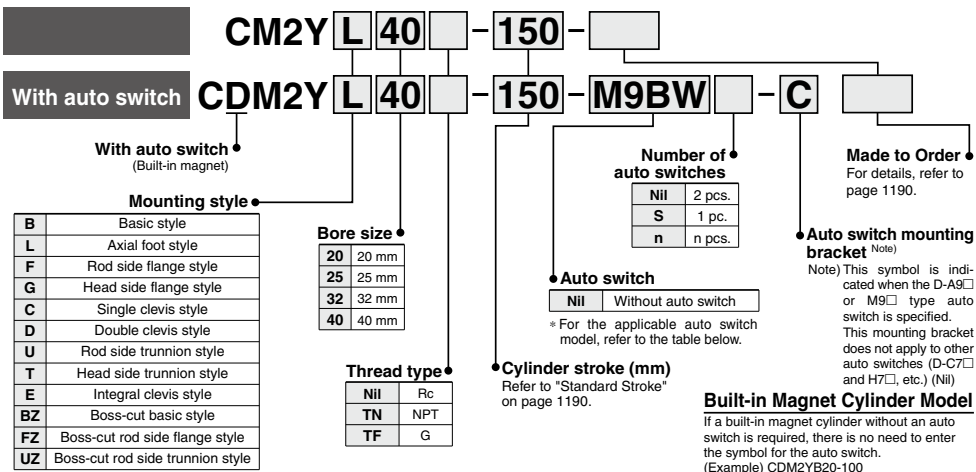

Applicable Auto Switches

Refer to pages 1893 to 2007 for further information on auto switches.

Type	Special function	Electrical entry	Indicator light	Wiring (Output)	Load voltage		Auto switch model		Lead wire length (m)					Pre-wired connector	Applicable load												
					DC	AC	Perpendicular	In-line	0.5 (Nil)	1 (M)	3 (L)	5 (Z)	None (N)														
Solid state auto switch	—	Grommet	No	3-wire (NPN)	5 V, 12 V	—	M9NV	M9N	●	●	○	○	○	IC circuit	Relay, PLC												
				3-wire (PNP)			M9PV	M9P	●	●	○	○	○														
		Connector	No	2-wire	12 V	—	M9BV	M9B	●	●	○	○	○	—													
				Terminal conduit	3-wire (NPN)	5 V, 12 V	—	G39A	—	—	—	—	—	—		IC circuit											
	Diagnostic indication (2-color indication)	Grommet	Yes	3-wire (NPN)	24 V	5 V, 12 V	—	M9NV	M9NW	●	●	○	○	○		IC circuit											
				3-wire (PNP)				M9PW	M9PW	●	●	○	○	○		—											
				2-wire				12 V	—	M9BW	M9BW	●	●	○		○	○	—									
				3-wire (NPN)				5 V, 12 V	—	M9NAV***	M9NA***	○	○	○		○	○	IC circuit									
				3-wire (PNP)				5 V, 12 V	—	M9PAV***	M9PA***	○	○	○		○	○	—									
				2-wire				12 V	—	M9BAV***	M9BA***	○	○	○		○	○	—									
Reed auto switch	—	Grommet	No	4-wire (NPN)	24 V	5 V, 12 V	—	H7NF	—	●	●	○	○	○	IC circuit												
				3-wire (NPN equivalent)				5 V	—	A96V	A96	●	●	○	○	○	IC circuit										
				100 V				—	A93V	A93	●	●	○	○	○	—											
				100 V or less				—	A90V	A90	●	●	○	○	○	IC circuit											
				100 V, 200 V				—	—	B54	●	●	○	○	○	—											
		Connector	No	Yes	2-wire	24 V	12 V	—	—	—	—	●	●	○	○	○	IC circuit										
																		24 V or less	—	C80C	●	●	○	○	○	—	
																		—	—	A33A	—	—	●	●	○	○	—
																		100 V, 200 V	—	A34A	—	—	●	●	○	○	—
																		—	—	A44A	—	—	●	●	○	○	—
Diagnostic indication (2-color indication)	Grommet	Yes	—	—	—	—	—	—	—	●	●	○	○	○	—												
																—	—	B59W	●	●	○	○	○	—			

*** Water resistant type auto switches can be mounted on the above models, but in such case SMC cannot guarantee water resistance.

Consult with SMC regarding water resistant types with the above model numbers.

* Lead wire length symbols: 0.5 m Nil (Example) M9NW * O: Manufactured upon receipt of order.

1 m M (Example) M9NWM * Do not add the suffix (N) indicating "no lead wire" to the part numbers of models D-A3□A,

3 m L (Example) M9NWL A44A, G39A and K39A.

5 m Z (Example) M9NWZ

None N (Example) H7CN

* In addition to the models in the above table, there are some other auto switches that are applicable. For more information, refer to page 1202.

* Refer to pages 1960 and 1961 for details of auto switches with a pre-wired connector.

* D-A9□(V)/M9□(V)/M9CW(V)/M9CA(V) auto switches are shipped together (not assembled). (Only auto switch mounting brackets are assembled before shipped.)

* D-C7□□/C80□/H7□□ auto switches are assembled at the time of shipment.

REA

REB

REC

COY

C□X

MQ

RHC

RZQ

D-□

-X□

Series CM2Y



Symbol

Double acting: Single rod, Rubber bumper

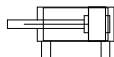

Integral clevis



Made to Order

(For details, refer to pages 2009 to 2152.)

Symbol	Specifications
-XA□	Change of rod end shape
-XC3	Special port location
-XC6	Made of stainless steel
-XC9	Adjustable stroke cylinder/adjustable retraction type
-XC13	Auto switch rail mounting style
-XC20	Head cover axial port

⚠ Precautions

Be sure to read before handling.
Refer to front matter 39 for Safety Instructions and pages 3 to 12 for Actuator and Auto Switch Precautions.

Handling Precautions

⚠ Warning

1. Do not rotate the cover

When installing a cylinder or screwing a fitting into the port, the coupling portion of the cover may be damaged if the cover rotates.

⚠ Caution

1. Be careful of the retaining ring to pop out.

When replacing the rod seal, be careful of the retaining ring not to pop out while removing it.

Replacement Part: Rod Seal

Bore size (mm)	Part no.
20	CM220-PS
25	CM225-PS
32	CM232-PS
40	CM240-PS

Grease Pack for Maintenance

When only grease for maintenance is necessary, please order by the following part numbers.

Grease pack part no.: GR-L-005 (5 g)
 GR-L-010 (10 g)
 GR-L-150 (150 g)

Specifications

Bore size (mm)	20	25	32	40
Action	Double acting, Single rod			
Piston speed	5 to 500 mm/s			
Fluid	Air			
Proof pressure	1.05 MPa			
Maximum operating pressure	0.7 MPa			
Ambient and fluid temperature	Without auto switch -10 to 70°C (with no freezing)			
	With auto switch -10 to 60°C (with no freezing)			
Lubrication	Non-lube			
Stroke length tolerance	+1.4 0 mm			
Cushion	Rubber bumper			
Allowable leakage rate	0.5 L/min (ANR) or less			

Minimum Operating Pressure

Unit: MPa				
Bore size (mm)	20	25	32	40
Minimum operating pressure	0.02			

Mounting Bracket Part No.

Mounting bracket	Minimum order	Bore size (mm)				Description (when ordering a minimum number)
		20	25	32	40	
Axial foot*	2	CM-L020B	CM-L032B	CM-L040B		Foot 2 pcs., Mounting nut 1 pc.
Flange	1	CM-F020B	CM-F032B	CM-F040B		Flange 1 pc.
Single clevis**	1	CM-C020B	CM-C032B	CM-C040B		Single clevis 1 pc., Liner 3 pcs.
Double clevis (with pin) ** , ***	1	CM-D020B	CM-D032B	CM-D040B		Double clevis 1 pc., Liner 3 pcs., Clevis pin 1 pc., Retaining ring 2 pcs.
Trunnion (with nut)	1	CM-T020B	CM-T032B	CM-T040B		Trunnion 1 pc., Trunnion nut 1 pc.

* When ordering foot brackets, order 2 pieces per cylinder unit.

** Three liners are included in the clevis bracket for adjusting an angle when mounting it.

*** Clevis pins and retaining rings (cotter pins for ø40) are included.

Mounting Bracket and Accessory

Accessory	Standard			Option				
	Mounting nut	Rod end nut	Clevis pin	Single knuckle joint	Double knuckle joint	Note 4) Clevis bracket	Note 6) Pivot bracket	Note 7) Pivot bracket pin
Basic style	● (1 pc.)	●	—	●	●	—		
Axial foot style	● (2)	●	—	●	●	—		
Rod side flange style	● (1)	●	—	●	●	—	—	—
Head side flange style	● (1)	●	—	●	●	—		
Integral clevis style	— Note 1)	●	—	●	●	●		
Single clevis style	— Note 1)	●	—	●	●	—	●	●
Double clevis style	— Note 1)	●	● Note 5)	●	●	—	—	—
Rod side trunnion style	● (1) Note 2)	●	—	●	●	—		
Head side trunnion style	● (1) Note 2)	●	—	●	●	—	●	—
Boss-cut basic style	● (1)	●	—	●	●	—		
Boss-cut flange style	● (1)	●	—	●	●	—	—	—
Boss-cut trunnion style	● (1)	●	—	●	●	—		

Note 1) Mounting nuts are not attached to the integral clevis, single clevis and double clevis types.

Note 2) Trunnion nuts are mounted on the rod side trunnion style and head side trunnion style.

Note 3) Pins and retaining rings (cotter pins in case of ø40) are packed with the double clevis and double knuckle joint styles.

Note 4) Pins and retaining rings are packed with clevis brackets.

Note 5) Retaining rings (cotter pins for ø40) are included in clevis pins.

Note 6) Pivot brackets come with pins and retaining rings.

Note 7) Pivot bracket pins come with retaining rings.

Standard Stroke

Bore size (mm)	Standard stroke (mm)
20, 25, 32, 40	25, 50, 75, 100, 125, 150, 200, 250, 300

Note 1) Manufacture of intermediate strokes at 1 mm intervals is possible. (Spacers are not used.)

Note 2) As the stroke increases, more sliding resistance may result due to the deflection of the piston rod and other factors. Take measures such as the installation of a guide.

Weight

(kg)

Bore size (mm)		20	25	32	40
Basic weight	Basic style	0.14	0.21	0.28	0.56
	Axial foot style	0.29	0.37	0.44	0.83
	Flange style	0.20	0.30	0.37	0.68
	Clevis integrated style	0.12	0.19	0.27	0.52
	Single clevis style	0.18	0.25	0.32	0.65
	Double clevis style	0.19	0.27	0.33	0.69
	Trunnion style	0.18	0.28	0.34	0.66
	Boss-cut basic style	0.13	0.19	0.26	0.53
	Boss-cut flange style	0.19	0.28	0.35	0.65
	Boss-cut trunnion style	0.17	0.26	0.32	0.63
Additional weight per each 50 mm of stroke		0.04	0.06	0.08	0.13
Option bracket	Clevis bracket (With pin)	0.07	0.07	0.14	0.14
	Single knuckle joint	0.06	0.06	0.06	0.23
	Double knuckle joint (With pin)	0.07	0.07	0.07	0.20

Calculation: (Example) **CM2YL32-100**

- Basic weight.....0.44 (Foot style, ø32)
- Additional weight.....0.08/50 stroke
- Cylinder stroke.....100 stroke
0.44 + 0.08 x 100/50 = 0.60 kg

Low Friction Cylinder Mounting

CM2Y - - X1854

Same mounting specification as CM2Q

In order to adjust the mounting dimensions of the low friction cylinder (CM2Q), extend the longitudinal dimension (S, ZZ) by 3 mm.

Specifications

Cylinder bore size (mm)	20	25	32	40
Action	Double acting, Single rod			
Direction of low friction	Dual directions			
Fluid	Air			
Proof pressure	1.05 MPa			
Maximum operating pressure	0.7 MPa			

* Low friction operates in dual directions.

Dimensions

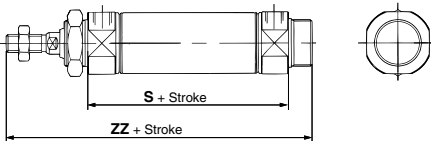

Bore size (mm)	S	ZZ
20	65	119
25	65	123
32	67	125
40	91	157

* Add 3 mm to S and ZZ dimensions of the double acting, single rod type on pages 1192 to 1196 for the dimensions for each mounting bracket other than the basic style.

REA

REB

REC

CEY

CEX

MQ

RHC

RZQ

D-□

-X□

Series CM2Y

Basic Style (B)

CM2YB —

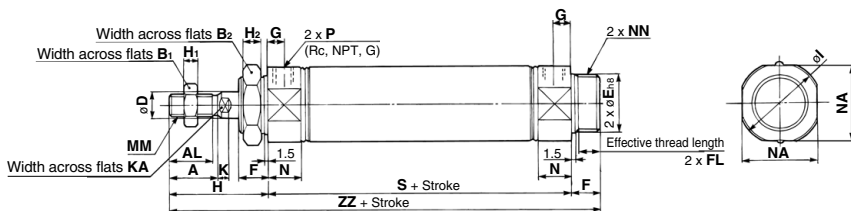

Boss-cut



Bore size (mm)	A	AL	B ₁	B ₂	D	E	F	FL	G	H	H ₁	H ₂	I	K	KA	MM	N	NA	NN	P	S	ZZ
20	18	15.5	13	26	8	20 ⁰ _{-0.033}	13	10.5	8	41	5	8	28	5	6	M8 x 1.25	15	24	M20 x 1.5	1/8	62	116
25	22	19.5	17	32	10	26 ⁰ _{-0.033}	13	10.5	8	45	6	8	33.5	5.5	8	M10 x 1.25	15	30	M26 x 1.5	1/8	62	120
32	22	19.5	17	32	12	26 ⁰ _{-0.033}	13	10.5	8	45	6	8	37.5	5.5	10	M10 x 1.25	15	34.5	M26 x 1.5	1/8	64	122
40	24	21	22	41	14	32 ⁰ _{-0.039}	16	13.5	11	50	8	10	46.5	7	12	M14 x 1.5	21.5	42.5	M32 x 2	1/4	88	154

Boss-cut (mm)

Bore size (mm)	ZZ
20	103
25	107
32	109
40	138

Axial Foot Style (L)

CM2YL —

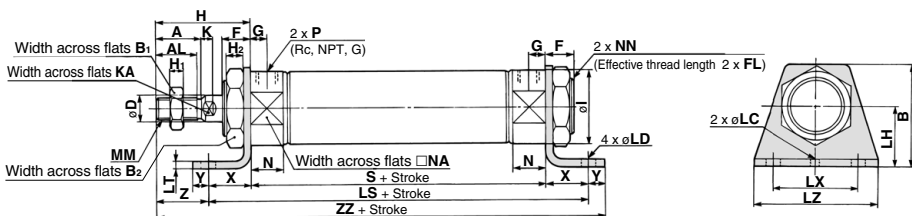

* Mounting bracket is shipped together with the product.

Bore size (mm)	A	AL	B	B ₁	B ₂	D	F	FL	G	H	H ₁	H ₂	I	K	KA	LC	LD	LH	LS	LT	LX	LZ	MM	N	NA	NN	P	S	X	Y	Z	ZZ
20	18	15.5	40	13	26	8	13	10.5	8	41	5	8	28	5	6	4	6.8	25	102	3.2	40	55	M8 x 1.25	15	24	M20 x 1.5	1/8	62	20	8	21	131
25	22	19.5	47	17	32	10	13	10.5	8	45	6	8	33.5	5.5	8	4	6.8	28	102	3.2	40	55	M10 x 1.25	15	30	M26 x 1.5	1/8	62	20	8	25	135
32	22	19.5	47	17	32	12	13	10.5	8	45	6	8	37.5	5.5	10	4	6.8	28	104	3.2	40	55	M10 x 1.25	15	34.5	M26 x 1.5	1/8	64	20	8	25	137
40	24	21	54	22	41	14	16	13.5	11	50	8	10	46.5	7	12	4	7	30	134	3.2	55	75	M14 x 1.5	21.5	42.5	M32 x 2	1/4	88	23	10	27	171

Rod Side Flange Style (F)

CM2YF —

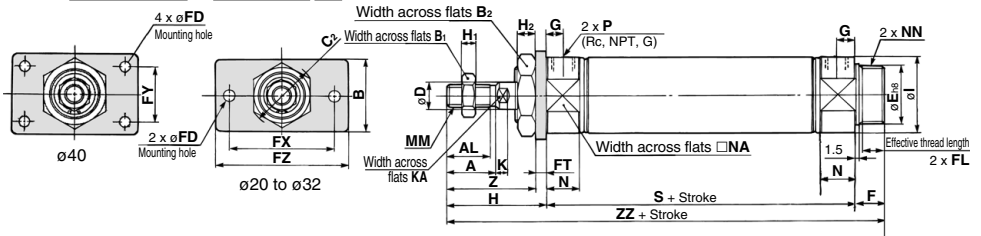

Boss-cut style

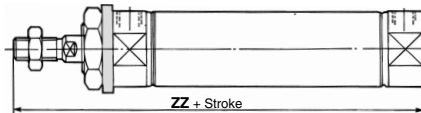

* Mounting bracket is shipped together with the product.

Bore size (mm)	A	AL	B	B ₁	B ₂	C ₂	D	E	F	FL	FD	FT	FX	FY	FZ	G	H	H ₁	H ₂	I	K	KA	MM	N	NA	NN	P	S	Z	ZZ
20	18	15.5	34	13	26	30	8	20 ⁰ _{-0.033}	13	10.5	7	4	60	—	75	8	41	5	8	28	5	6	M8 x 1.25	15	24	M20 x 1.5	1/4	62	37	116
25	22	19.5	40	17	32	37	10	26 ⁰ _{-0.033}	13	10.5	7	4	60	—	75	8	45	6	8	33.5	5.5	8	M10 x 1.25	15	30	M26 x 1.5	1/4	62	41	120
32	22	19.5	40	17	32	37	12	26 ⁰ _{-0.033}	13	10.5	7	4	60	—	75	8	45	6	8	37.5	5.5	10	M10 x 1.25	15	34.5	M26 x 1.5	1/8	64	41	122
40	24	21	52	22	41	47.3	14	32 ⁰ _{-0.039}	16	13.5	7	5	66	36	82	11	50	8	10	46.5	7	12	M14 x 1.5	21.5	42.5	M32 x 2	1/4	88	45	154

Boss-cut Style (mm)

Bore size (mm)	ZZ
20	103
25	107
32	109
40	138

- REA
- REB
- REC
- C_Y
- C_X
- MQ
- RHC
- RZQ

- D-□
- X□

Series CM2Y

Head Side Flange Style (G)

CM2YG —

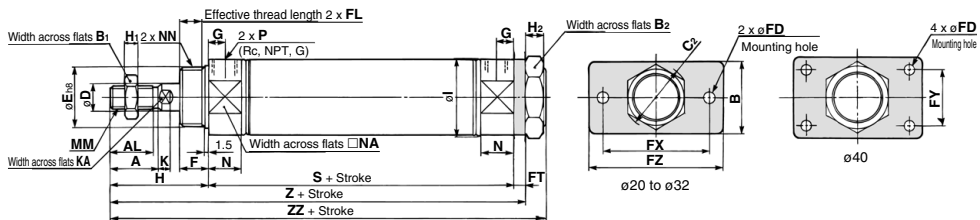

* Mounting bracket is shipped together with the product. (mm)

Bore size (mm)	A	AL	B	B ₁	B ₂	C	D	E	F	FL	FD	FT	FX	FY	FZ	G	H	H ₁	H ₂	I
20	18	15.5	34	13	26	30	8	20 ⁰ _{-0.033}	13	10.5	7	4	60	—	75	8	41	5	8	28
25	22	19.5	40	17	32	37	10	26 ⁰ _{-0.033}	13	10.5	7	4	60	—	75	8	45	6	8	33.5
32	22	19.5	40	17	32	37	12	26 ⁰ _{-0.033}	13	10.5	7	4	60	—	75	8	45	6	8	37.5
40	24	21	52	22	41	47.3	14	32 ⁰ _{-0.039}	16	13.5	7	5	66	36	82	11	50	8	10	46.5

(mm)

Bore size (mm)	K	KA	MM	N	NA	NN	P	S	Z	ZZ
20	5	6	M8 x 1.25	15	24	M20 x 1.5	1/8	62	107	116
25	5.5	8	M10 x 1.25	15	30	M26 x 1.5	1/8	62	111	120
32	5.5	10	M10 x 1.25	15	34.5	M26 x 1.5	1/8	64	113	122
40	7	12	M14 x 1.5	21.5	42.5	M32 x 2	1/4	88	143	154

Single Clevis Style (C)

CM2YC —

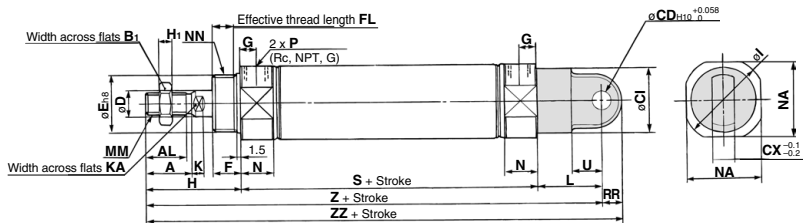

(mm)

Bore size (mm)	A	AL	B ₁	C ₁	CD	CX	D	E	F	FL	G	H	H ₁	I	K	KA	L	MM	N	NA	NN	P	RR	S	U	Z	ZZ
20	18	15.5	13	24	9	10	8	20 ⁰ _{-0.033}	13	10.5	8	41	5	28	5	6	30	M8 x 1.25	15	24	M20 x 1.5	1/8	9	62	14	133	142
25	22	19.5	17	30	9	10	10	26 ⁰ _{-0.033}	13	10.5	8	45	6	33.5	5.5	8	30	M10 x 1.25	15	30	M26 x 1.5	1/8	9	62	14	137	146
32	22	19.5	17	30	9	10	12	26 ⁰ _{-0.033}	13	10.5	8	45	6	37.5	5.5	10	30	M10 x 1.25	15	34.5	M26 x 1.5	1/8	9	64	14	139	148
40	24	21	22	38	10	15	14	32 ⁰ _{-0.039}	16	13.5	11	50	8	46.5	7	12	39	M14 x 1.5	21.5	42.5	M32 x 2	1/4	11	88	18	177	188

Double Clevis Style (D)

CM2YD —

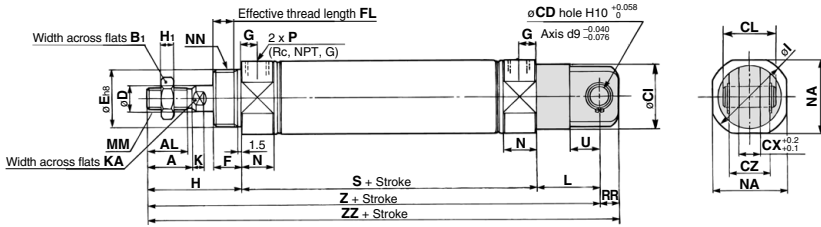

Bore size (mm)	A	AL	B ₁	CD	CI	CL	CX	CZ	D	E	F	FL	G	H	H ₁	I	K	KA	L	MM	N	NA	NN	P	RR	S	U	Z	ZZ
20	18	15.5	13	9	24	25	10	19	8	20 ^{-0.033}	13	10.5	8	41	5	28	5	6	30	M8 x 1.25	15	24	M20 x 1.5	1/8	9	62	14	133	142
25	22	19.5	17	9	30	25	10	19	10	26 ^{-0.033}	13	10.5	8	45	6	33.5	5.5	8	30	M10 x 1.25	15	30	M26 x 1.5	1/8	9	62	14	137	146
32	22	19.5	17	9	30	25	10	19	12	26 ^{-0.033}	13	10.5	8	45	6	37.5	5.5	10	30	M10 x 1.25	15	34.5	M26 x 1.5	1/8	9	64	14	139	148
40	24	21	22	10	38	41.2	15	30	14	32 ^{-0.039}	16	13.5	11	50	8	46.5	7	12	39	M14 x 1.5	21.5	42.5	M32 x 2	1/4	11	88	18	177	188

* Clevis pin and snap ring (cotter pin for bore size ø40) are shipped together.

Rod Side Trunnion Style (U)

CM2YU —

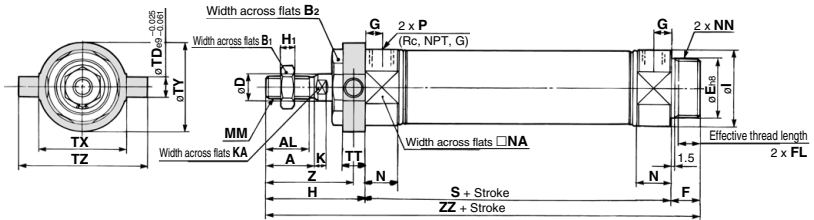

Boss-cut style

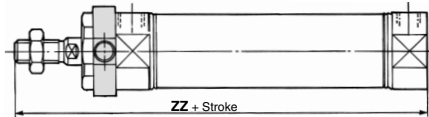

* Mounting bracket is shipped together with the product.

Bore size (mm)	A	AL	B ₁	B ₂	D	E	F	FL	G	H	H ₁	I	K	KA	MM	N	NA	NN	P
20	18	15.5	13	26	8	20 ^{-0.033}	13	10.5	8	41	5	28	5	6	M8 x 1.25	15	24	M20 x 1.5	1/8
25	22	19.5	17	32	10	26 ^{-0.033}	13	10.5	8	45	6	33.5	5.5	8	M10 x 1.25	15	30	M26 x 1.5	1/8
32	22	19.5	17	32	12	26 ^{-0.033}	13	10.5	8	45	6	37.5	5.5	10	M10 x 1.25	15	34.5	M26 x 1.5	1/8
40	24	21	22	41	14	32 ^{-0.039}	16	13.5	11	50	8	46.5	7	12	M14 x 1.5	21.5	42.5	M32 x 2	1/4

Bore size (mm)	S	TD	TT	TX	TY	TZ	Z	ZZ
20	62	8	10	32	32	52	36	116
25	62	9	10	40	40	60	40	120
32	64	9	10	40	40	60	40	122
40	88	10	11	53	53	77	44.5	154

Boss-cut Style (mm)

Bore size (mm)	ZZ
20	103
25	107
32	109
40	138

- REA
- REB
- REC
- CY
- CX
- MQ
- RHC
- RZQ

- D
- X

Series CM2Y

Head Side Trunnion Style (T)

CM2YT Bore size — Stroke

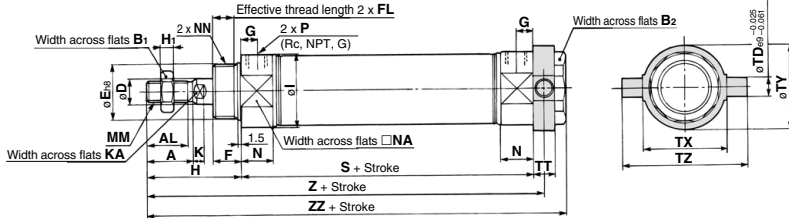

* Mounting bracket is shipped together with the product.

(mm)

Bore size (mm)	A	AL	B ₁	B ₂	D	E	F	FL	G	H	H ₁	I	K	KA	MM	N	NA	NN	P
20	18	15.5	13	26	8	20 ⁰ _{-0.033}	13	10.5	8	41	5	28	5	6	M8 x 1.25	15	24	M20 x 1.5	1/8
25	22	19.5	17	32	10	26 ⁰ _{-0.033}	13	10.5	8	45	6	33.5	5.5	8	M10 x 1.25	15	30	M26 x 1.5	1/8
32	22	19.5	17	32	12	26 ⁰ _{-0.033}	13	10.5	8	45	6	37.5	5.5	10	M10 x 1.25	15	34.5	M26 x 1.5	1/8
40	24	21	22	41	14	32 ⁰ _{-0.039}	16	13.5	11	50	8	46.5	7	12	M14 x 1.5	21.5	42.5	M32 x 2	1/4

(mm)

Bore size (mm)	S	TD	TT	TX	TY	TZ	Z	ZZ
20	62	8	10	32	32	52	108	118
25	62	9	10	40	40	60	112	122
32	64	9	10	40	40	60	114	124
40	88	10	11	53	53	77	143.5	154

Clevis Integrated Style (E)

CM2YE Bore size — Stroke

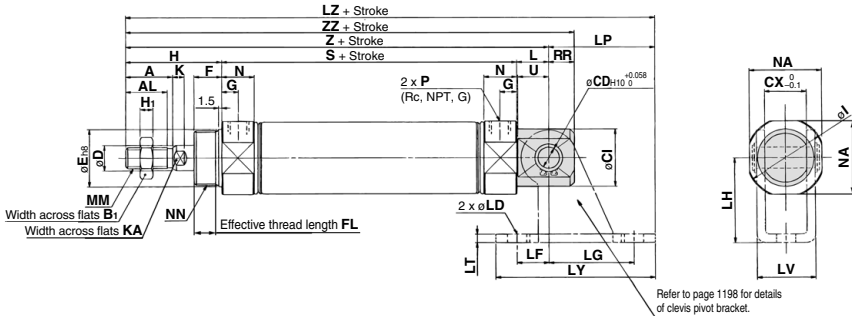

Refer to page 1198 for details of clevis pivot bracket.

(mm)

Bore size (mm)	A	AL	B ₁	CD	CI	CX	D	E	F	FL	G	H	H ₁	I	K	KA	L	MM	N	NA	NN
20	18	15.5	13	8	20	12	8	20 ⁰ _{-0.033}	13	10.5	8	41	5	28	5	6	12	M8 x 1.25	15	24	M20 x 1.5
25	22	19.5	17	8	22	12	10	26 ⁰ _{-0.033}	13	10.5	8	45	6	33.5	5.5	8	12	M10 x 1.25	15	30	M26 x 1.5
32	22	19.5	17	10	27	20	12	26 ⁰ _{-0.033}	13	10.5	8	45	6	37.5	5.5	10	15	M10 x 1.25	15	34.5	M26 x 1.5
40	24	21	22	10	33	20	14	32 ⁰ _{-0.039}	16	13.5	11	50	8	46.5	7	12	15	M14 x 1.5	21.5	42.5	M32 x 2

(mm)

Bore size (mm)	P	RR	S	U	Z	ZZ
20	1/8	9	62	11.5	115	124
25	1/8	9	62	11.5	119	128
32	1/8	12	64	14.5	124	136
40	1/4	12	88	14.5	153	165

Series CM2Y

Accessory Bracket Dimensions

Single Knuckle Joint

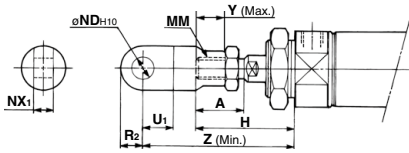

Bore size	A	H	MM	NDH10	NX1	U1	R2	Y	Z
20	18	41	M8 x 1.25	9 ^{+0.058/0}	9 ^{-0.1/-0.2}	14	10	11	66
25, 32	22	45	M10 x 1.25	9 ^{+0.058/0}	9 ^{-0.1/-0.2}	14	10	14	69
40	24	50	M14 x 1.5	12 ^{+0.070/0}	16 ^{-0.1/-0.3}	20	14	13	92

Single Knuckle Joint

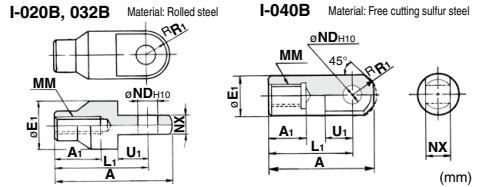

Part no.	Applicable bore size (mm)	A	A1	E1	L1	MM	NDH10	NX	R1	U1
I-020B	20	46	16	20	36	M8 x 1.25	9 ^{+0.058/0}	9 ^{-0.1/-0.2}	10	14
I-032B	25, 32	48	18	20	38	M10 x 1.25	9 ^{+0.058/0}	9 ^{-0.1/-0.2}	10	14
I-040B	40	69	22	24	55	M14 x 1.5	12 ^{+0.070/0}	16 ^{-0.1/-0.3}	15.5	20

Double Knuckle Joint

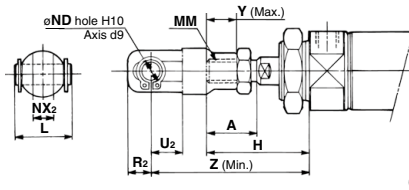

Bore size	A	H	L	MM	ND	NX2	R2	U2	Y	Z
20	18	41	25	M8 x 1.25	9	9 ^{+0.2/-0.1}	10	14	11	66
25, 32	22	45	25	M10 x 1.25	9	9 ^{+0.2/-0.1}	10	14	14	69
40	24	50	49.7	M14 x 1.5	12	16 ^{+0.3/-0.1}	13	25	13	92

Double Knuckle Joint

Y-020B, Y-032B Material: Rolled steel Y-040B Material: Cast iron

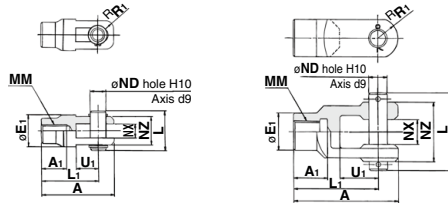

Part no.	Applicable bore size	A	A1	E1	L	L1	MM	ND	NX	NZ	R1	U1	Applicable pin part number	Retaining ring Cotter pin size
Y-020B	20	46	16	20	25	36	M8 x 1.25	9	9 ^{+0.2/-0.1}	18	5	14	CDP-1	Type C 9 for axis
Y-032B	25, 32	48	18	20	25	38	M10 x 1.25	9	9 ^{+0.2/-0.1}	18	5	14	CDP-1	Type C 9 for axis
Y-040B	40	68	22	24	49.7	55	M14 x 1.5	12	16 ^{+0.3/-0.1}	38	13	25	CDP-3	ø3 x 18 L

* Clevis pin and retaining ring (cotter pin for ø40) are attached.

Double Clevis Pin/Material: Carbon steel (mm)

Bore size: ø20, ø25, ø32
CDP-1

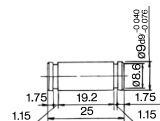

Retaining ring: Type C9 for axis

* Retaining rings (cotter pins for ø40) are included.

Bore size: ø40
CDP-2

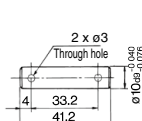

Cotter pin ø3 x 18 L

Double Knuckle Pin/Material: Carbon steel (mm)

Bore size: ø20, ø25, ø32
CDP-1

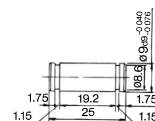

Retaining ring: Type C9 for axis

* Retaining rings (cotter pins for ø40) are included.

Bore size: ø40
CDP-3

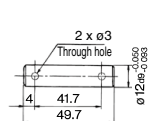

Cotter pin ø3 x 18 L

REA
REB
REC
CXY
CXX
MQ
RHC
RZQ

D-□
-X□

Series CM2Y

Rod End Nut

Material: Carbon steel

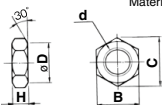

Part no.	Applicable bore size (mm)	B	C	D	d	H
NT-02	20	13	15.0	12.5	M8 x 1.25	5
NT-03	25, 32	17	19.6	16.5	M10 x 1.25	6
NT-04	40	22	25.4	21.0	M14 x 1.5	8

Mounting Nut

Material: Carbon steel

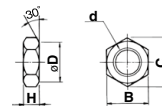

Part no.	Applicable bore size (mm)	B	C	D	d	H
SN-020B	20	26	30	25.5	M20 x 1.5	8
SN-032B	25, 32	32	37	31.5	M26 x 1.5	8
SN-040B	40	41	47.3	40.5	M32 x 2.0	10

Trunnion Nut

Material: Carbon steel

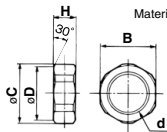

Part no.	Applicable bore size (mm)	B	C	D	d	H
TN-020B	20	26	28	25.5	M20 x 1.5	10
TN-032B	25, 32	32	34	31.5	M26 x 1.5	10
TN-040B	40	41	45	40.5	M32 x 2	10

Clevis Pivot Bracket (For CM2E)

Material: Rolled steel plate

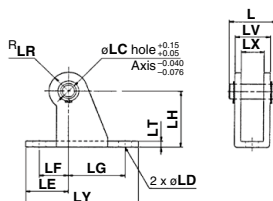

Part no.	Applicable bore size (mm)	L	LC	LD	LE	LF	LG	LH	LR	LT	LX	LY	LV	Applicable pin part no.
CM-E020B	20, 25	24.5	8	6.8	22	15	30	30	10	3.2	12	59	18.4	CD-S02
CM-E032B	32, 40	34	10	9	25	15	40	40	13	4	20	75	28	CD-S03

Note 1) Clevis bracket pins and retaining rings are included.

Note 2) It cannot be used for single clevis style (CM2C) and double clevis style (CM2D).

Clevis Pin (For CM2E)

Material: Carbon steel

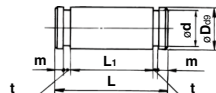

Part no.	Applicable bore size (mm)	D _{d9}	d	L	L ₁	m	t	Applicable retaining ring part no.
CD-S02	20, 25	8 ^{+0.040} _{-0.076}	7.6	24.5	19.5	1.6	0.9	Type C 8 for axis
CD-S03	32, 40	10 ^{+0.040} _{-0.076}	9.6	34	29	1.35	1.15	Type C 10 for axis

Note) Retaining rings are included.

Refer to page 2048 (~XB12: External stainless steel cylinder) for stainless steel mounting brackets and accessories (some are not applicable.)

Refer to Best Pneumatics No.2 for pivot brackets.

Series CM2Y

Auto Switch Mounting 1

Auto Switch Proper Mounting Position (Detection at Stroke End) and Its Mounting Height

Reed auto switch

D-A9□

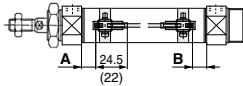

(): Values for D-A96
A and B are the dimensions from the end of the head cover/rod cover to the end of the auto switch.

D-C7/C8

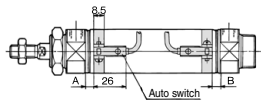

D-B5/B6/B59W

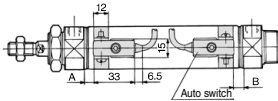

D-A33A/A34A

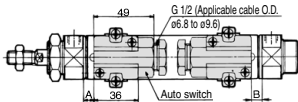
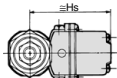

D-A44A

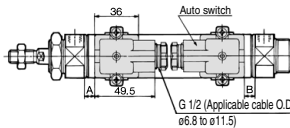
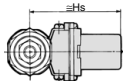

D-C73C/C80C

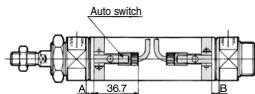

Solid state auto switch

D-M9□
D-M9□W
D-M9□A

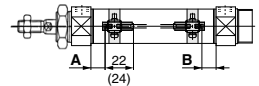

(): Values for D-M9□A
A and B are the dimensions from the end of the head cover/rod cover to the end of the auto switch.

D-H7□/H7□W/H7NF

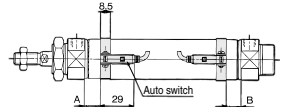

D-G5NT

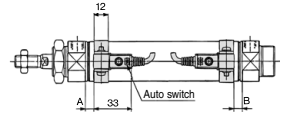

D-G39A/K39A

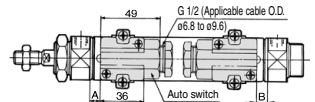
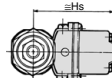

D-H7C

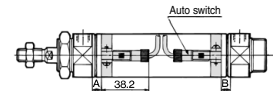

REA

REB

REC

□Y

□X

MQ

RHC

RZQ

D-□

-X□

Auto Switch Mounting 2

Auto Switch Proper Mounting Position (Detection at Stroke End) and Its Mounting Height

Auto Switch Proper Mounting Position

(mm)

Auto switch model	D-A9□ (V)		D-M9□ (V) D-M9□W (V) D-M9□A (V)		D-B5□ D-B64		D-C7□ D-C80 D-C73C D-C80C		D-B59W		D-A3□A D-G39A D-K39A D-A44A		D-H7□ D-H7C D-H7□W D-H7NF		D-G5NT	
	A	B	A	B	A	B	A	B	A	B	A	B	A	B	A	B
20	6.5	5.5	10.5	9.5	1	0	7	6	4	3	0.5	0	6	5	2.5	1.5
25	6.5	5.5	10.5	9.5	1	0	7	6	4	3	0.5	0	6	5	2.5	1.5
32	7.5	6.5	11.5	10.5	2	1	8	7	5	4	1.5	0.5	7	6	3.5	2.5
40	13.5	11.5	17.5	15.5	7	6	13	12	10	9	6.5	5.5	12	11	8.5	7.5

Note) Adjust the auto switch after confirming the operating conditions in the actual setting.

Auto Switch Mounting Height

(mm)

Auto switch model	D-A9□V D-M9□V D-M9□WV D-M9□AV		D-B5□ D-B64 D-B59W D-G5NT D-H7C		D-M9□ D-M9□W D-M9□A D-A9□ D-C7□ D-C80 D-H7□ D-H7□W D-H7NF		D-C73C D-C80C		D-A3□A D-G39A D-K39A		D-A44A	
	Hs	Hs	Hs	Hs	Hs	Hs	Hs	Hs	Hs	Hs		
20	23.5	25.5	22.5	25	60	69.5						
25	26	28	25	27.5	62.5	72						
32	29.5	31.5	28.5	31	66	75.5						
40	33.5	35.5	32.5	35	70	79.5						

Minimum Auto Switch Mounting Stroke

Auto switch model	n: No. of auto switch (mm)				
	1 pc.	No. of auto switch mounted		n pcs.	
		2 pcs.		Different surfaces	Same surface
D-M9□	5	20	55	$20 + 35 \frac{(n-2)}{2}$ (n=2, 4, 6...) <small>Note 3)</small>	$55 + 35 (n-2)$ (n=2, 3, 4, 5...)
D-M9□W	10	20	55	$20 + 35 \frac{(n-2)}{2}$ (n=2, 4, 6...) <small>Note 3)</small>	$55 + 35 (n-2)$ (n=2, 3, 4, 5...)
D-M9□A	10	25	60	$25 + 35 \frac{(n-2)}{2}$ (n=2, 4, 6...) <small>Note 3)</small>	$60 + 35 (n-2)$ (n=2, 3, 4, 5...)
D-A9□	5	15	50	$15 + 35 \frac{(n-2)}{2}$ (n=2, 4, 6...) <small>Note 3)</small>	$50 + 35 (n-2)$ (n=2, 3, 4, 5...)
D-M9□V	5	20	35	$20 + 35 \frac{(n-2)}{2}$ (n=2, 4, 6...) <small>Note 3)</small>	$35 + 35 (n-2)$ (n=2, 3, 4, 5...)
D-A9□V	5	15	25	$15 + 35 \frac{(n-2)}{2}$ (n=2, 4, 6...) <small>Note 3)</small>	$25 + 35 (n-2)$ (n=2, 3, 4, 5...)
D-M9□WV D-M9□AV	10	20	35	$20 + 35 \frac{(n-2)}{2}$ (n=2, 4, 6...) <small>Note 3)</small>	$35 + 35 (n-2)$ (n=2, 3, 4, 5...)
D-C7□ D-C80	10	15	50	$15 + 45 \frac{(n-2)}{2}$ (n=2, 4, 6...) <small>Note 3)</small>	$50 + 45 (n-2)$ (n=2, 3, 4, 5...)
D-H7□ D-H7□W D-H7NF	10	15	60	$15 + 45 \frac{(n-2)}{2}$ (n=2, 4, 6...) <small>Note 3)</small>	$60 + 45 (n-2)$ (n=2, 3, 4, 5...)
D-C73C D-C80C D-H7C	10	15	65	$15 + 50 \frac{(n-2)}{2}$ (n=2, 4, 6...) <small>Note 3)</small>	$65 + 50 (n-2)$ (n=2, 3, 4, 5...)
D-B5□/B64 D-G5NT	10	15	75	$15 + 50 \frac{(n-2)}{2}$ (n=2, 4, 6...) <small>Note 3)</small>	$75 + 55 (n-2)$ (n=2, 3, 4, 5...)
D-B59W	15	20	75	$20 + 50 \frac{(n-2)}{2}$ (n=2, 4, 6...) <small>Note 3)</small>	$75 + 55 (n-2)$ (n=2, 3, 4, 5...)
D-A3□A/G39A D-K39A/A44A	10	35	100	$35 + 30 (n-2)$ (n=2, 3, 4, 5...)	$100 + 100 (n-2)$ (n=2, 3, 4, 5...)

Note 3) When "n" is an odd number, an even number that is one larger than this odd number is used for the calculation.

Note 1) Auto switch mounting

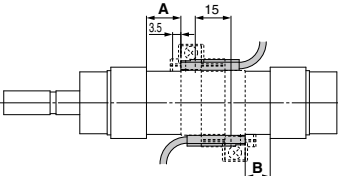
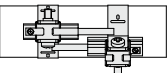
Auto switch model	With 2 auto switches	
	Different surfaces	Same surface
	 <p>Correct auto switch mounting position is 3.5 mm from the back face of the switch holder.</p>	 <p>The auto switch is mounted by slightly displacing it in a direction (cylinder tube circumferential exterior) so that the auto switch and lead wire do not interfere with each other.</p>
D-M9□ D-M9□W	Less than 20 stroke <small>Note 2)</small>	Less than 55 stroke <small>Note 2)</small>
D-M9□A	Less than 25 stroke <small>Note 2)</small>	Less than 60 stroke <small>Note 2)</small>
D-A9□	—	Less than 50 stroke <small>Note 2)</small>

Note 2) Minimum stroke for auto switch mounting in styles other than those in Note 1.

Operating Range

Auto switch model	(mm)			
	20	25	32	40
D-A9□(V)	6	6	6	6
D-M9□(V) D-M9□W(V) D-M9□A(V)	3.5	3	3.5	3
D-C7□/C80 D-C73C/C80C	7	8	8	8
D-B5□/B64 D-A3□A/A44A	8	8	9	9

Auto switch model	(mm)			
	20	25	32	40
D-B59W	12	12	13	13
D-H7□/H7□W D-G5NT/H7NF	4	4	4.5	5
D-H7C	7	8.5	9	10
D-G39A/K39A	8	9	9	9

* Since this is a guideline including hysteresis, not meant to be guaranteed. (Assuming approximately ±30% dispersion)
There may be the case it will vary substantially depending on an ambient environment.

Note) D-A9□ and D-A9□V cannot be mounted on ø50.

REA
REB
REC
COY
C0X
MQ
RHC
RZQ

D-□
-X□

Auto Switch Mounting 3

Auto Switch Mounting Bracket Part No.

Auto switch model	Bore size (mm)			
	20	25	32	40
D-M9□ (V) D-M9□W (V) D-A9□ (V)	Note 1 BM5-020	Note 1 BM5-025	Note 1 BM5-032	Note 1 BM5-040
D-M9□A (V)	Note 2 BM5-020S	Note 2 BM5-025S	Note 2 BM5-032S	Note 2 BM5-040S
D-C7□/C80 D-C73C/C80C D-H7□ D-H7□W D-H7NF	BM2-020A	BM2-025A	BM2-032A	BM2-040A
D-B5□/B64 D-B59W D-G5NT	BA2-020	BA2-025	BA2-032	BA2-040
D-A3□A/A44A D-G39A/K39A	BM3-020	BM3-025	BM3-032	BM3-040

Note 1) Set part number which includes the auto switch mounting band (BM2-□□□A) and the holder kit (BJ5-1/Switch bracket: Transparent).

Since the switch bracket (made from nylon) is affected in an environment where alcohol, chloroform, methylamines, hydrochloric acid or sulfuric acid is splashed over, so it cannot be used. Please consult SMC regarding other chemicals.

Note 2) Set part number which includes the auto switch mounting band (BM2-□□□AS) and the holder kit (BJ4-1/Switch bracket: White).

Note 3) For the D-M9□A (V) type auto switch, do not install the switch bracket on the indicator light.

[Stainless Steel Mounting Screw Kit]

The following set of stainless steel mounting screws is available. Use them in accordance with the operating environment.

(Since auto switch brackets are not included, order them separately.)

BBA4: For D-C7/C8/H7 types

Note 4) Refer to page 1990 for the details of BBA4 screws.

The above stainless steel screws are used when a cylinder is shipped with D-H7BA type auto switches.

When only a switch is shipped independently, BBA4 screws are attached.

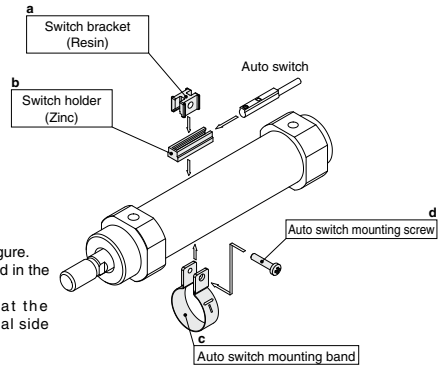

①BJ□-1: A set of a and b in the figure.

②BM2-□□□A (S): A set of c and d in the figure.

Band (c) is mounted so that the projected part is on the internal side (contact side with the tube).

BJ4-1 (Switch bracket: White)

BJ5-1 (Switch bracket: Transparent)

Other than the applicable auto switches listed in "How to Order", the following auto switches can be mounted.

For detailed specifications, refer to pages 1893 to 2007.

Auto switch type	Model	Electrical entry (Direction)	Features
Solid state	D-H7A1, H7A2, H7B	Grommet (In-line)	—
	D-H7NW, H7PW, H7BW		Diagnostic indication (2-color indication)
	D-H7BA		Water resistant (2-color indication)
	D-G5NT		With timer
Reed	D-B53, C73, C76		—
	D-C80	Without indicator light	

* With pre-wired connector is available for solid state auto switches. For details, refer to pages 1960 and 1961.

* Normally closed (NC = b contact), solid state auto switches (D-F9G, F9H type) are also available. For details, refer to page 1911.

* Wide range detection type, solid state auto switches (D-GNB type) are also available. Refer to page 1953 for details.

Smooth Cylinder

Series CG1Y

ø20, ø25, ø32, ø40, ø50, ø63, ø80, ø100

How to Order

CG1Y **L** **25** **100**

With auto switch **CDG1Y** **L** **25** **100** **M9BW** **C**

With auto switch
(Built-in magnet)

Mounting style

B	Basic style
L	Axial foot style
F	Rod side flange style
G	Head side flange style
U*	Rod side trunnion style
T*	Head side trunnion style
D	Clevis style

* Not available at ø80 and ø100.
Note) Mounting brackets are not mounted and are supplied loose at the time of shipment.

Bore size

20	20 mm
25	25 mm
32	32 mm
40	40 mm
50	50 mm
63	63 mm
80	80 mm
100	100 mm

Port thread type

Nil	Rc	ø20 to ø100
TN	NPT	ø20 to ø100
TF	M5 x 0.8	ø20, ø25
	G	ø32 to ø100

Auto switch

Nil Without auto switch

* For the applicable auto switch model, refer to the table below.

Cylinder stroke (mm)
Refer to "Standard Stroke" on page 1204.

Made to Order
For details, refer to page 1204.

Auto switch mounting bracket
Note) This symbol is indicated when the D-A9□ or M9□ type auto switch is specified. This mounting bracket does not apply to other auto switches (D-C7□ and H7□, etc.) (Nil)

Number of auto switches

Nil	2 pcs.
S	1 pc.
n	n pcs.

Built-in Magnet Cylinder Model
If a built-in magnet cylinder without an auto switch is required, there is no need to enter the symbol for the auto switch.
(Example) CDG1YB32-150

Applicable Auto Switches

Refer to pages 1893 to 2007 for further information on auto switches.

Type	Special function	Electrical entry	Indicator light	Wiring (Output)	Load voltage		Auto switch model				Lead wire length (m)	Pre-wired connector	Applicable load				
					DC	AC	Applicable bore size			0.5 (Nil)				1 (M)	3 (L)	5 (Z)	None (N)
							ø20 to ø63	ø80, ø100	Perpendicular								
Solid state auto switch		Grommet	No	3-wire (NPN)	5 V, 12 V		M9NV	M9N	G59	●	●	○	○	IC circuit			
				3-wire (PNP)			M9PV	M9P	G5P	●	●	○	○				
		Connector		2-wire	12 V		M9BV	M9B	K59	●	●	○	○	—			
							H7C	●	●	●	●						
	Diagnostic indication (2-color indication)	Grommet	Yes	3-wire (NPN)	24 V	5 V, 12 V	—	M9NWV	M9NW	G59W	●	●	○	○	IC circuit		
				3-wire (PNP)				M9PWV	M9PW	G5PW	●	●	○	○			
				2-wire	12 V		M9BWV	M9BW	K59W	●	●	○	○	—			
				Water resistant (2-color indication)	Grommet	No	3-wire (NPN)	5 V, 12 V		M9NAV***	M9NA***	—	○	○	○	○	IC circuit
							3-wire (PNP)			M9PAV***	M9PA***	—	○	○	○	○	
Reed auto switch		Grommet	Yes	2-wire	24 V	12 V		A96V	A96	—	●	●	●	IC circuit			
								A93V	A93	—	●	●	●				
		Connector		No							B54	B64	—	●	●	—	
											C73C	—	—	●	●		●
Diagnostic indication (2-color indicator)	Grommet	Yes	3-wire (NPN equivalent)	—	5 V	—		A90V	A90	—	●	●	●	IC circuit			
								C80C	—	—	●	●	●	IC circuit			
								B59W	—	—	●	●	●				

*** Water resistant type auto switches can be mounted on the above models, but in such case SMC cannot guarantee water resistance. Consult with SMC regarding water resistant types with the above model numbers.

* Lead wire length symbols: 0.5 m Nil (Example) M9NW * ○: Manufactured upon receipt of order.

1 m M (Example) M9NWM
3 m L (Example) M9NWL
5 m Z (Example) M9NWZ
None N (Example) H7CN

* In addition to the models in the above table, there are some other auto switches that are applicable. For more information, refer to page 1213.

** Refer to pages 1960 and 1961 for details of auto switches with a pre-wired connector.

* D-A9□(V)/M9□(V)/M9□W(V)/M9□A(V) auto switches are shipped together (not assembled). (Only auto switch mounting brackets are assembled before shipped.)

REA

REB

REC

COY

COX

MQ

RHC

RZQ

D-□

-X□

Series CG1Y



Symbol

Rubber bumper

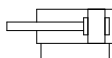

Made to Order

(For details, refer to pages 2009 to 2152.)

Symbol	Specifications
-XA <input type="checkbox"/>	Change of rod end shape
-XC6	Made of stainless steel
-XC20	Head cover axial port

Replacement Parts: Seal Kit

Bore size (mm)	Kit no.	Contents
20	CG1Y20-PS	Piston seal 1 pc.
25	CG1Y25-PS	Rod seal 1 pc.
32	CG1Y32-PS	Tube gasket 2 pcs.
40	CG1Y40-PS	Grease pack (10 g) 1 pc.

When only grease for maintenance is necessary, please order by the following part numbers.

Grease pack part no.: GR-L-005 (5 g)
GR-L-010 (10 g)
GR-L-150 (150 g)

Specifications

Bore size (mm)	20	25	32	40	50	63	80	100
Action	Double acting, Single rod							
Type	Non-lube							
Fluid	Air							
Proof pressure	1.05 MPa							
Maximum operating pressure	0.7 MPa							
Ambient and fluid temperature	Without auto switch -10 to 70°C (with no freezing) With auto switch -10 to 60°C (with no freezing)							
Operating piston speed	5 to 500 mm/s							
Stroke length tolerance	Up to 300 st + ₀ rd mm							
Cushion	Rubber bumper							
Mounting	Basic, Axial foot, Rod side flange, Head side flange, Rod side trunnion, Head side trunnion, Clevis (in case of 90° change in port location)							
Allowable leakage rate	0.5 L/min (ANR) or less							

* Rod side trunnion and head side trunnion styles are not available at ø80 and ø100.

Minimum Operating Pressure

Bore size (mm)	20	25	32	40	50	63	80	100
Minimum operating pressure	0.02				0.01			

Unit: MPa

Standard Stroke

Bore size (mm)	Standard stroke (mm) ^{Note 1)}
20	25, 50, 75, 100, 125, 150, 200
25, 32, 40, 50, 63, 80, 100	25, 50, 75, 100, 125, 150, 200, 250, 300

Note 1) Manufacture of intermediate strokes at 1 mm intervals is possible. (Spacers are not used.)

Note 2) Please consult with SMC for strokes outside the above ranges.

Note 3) As the stroke increases, more sliding resistance may result due to the deflection of the piston rod and other factors. Take measures such as the installation of a guide.

Mounting Bracket Part No.

Mounting bracket	Min. order	Bore size (mm)								Description
		20	25	32	40	50	63	80	100	
Foot	2 ¹⁾²⁾	CG-L020	CG-L025	CG-L032	CG-L040	CG-L050	CG-L063	CG-L080	CG-L100	Foot x 2, Bracket mounting bolt x 8
Flange	1	CG-F020	CG-F025	CG-F032	CG-F040	CG-F050	CG-F063	CG-F080	CG-F100	Flange x 1, Bracket mounting bolt x 4
Trunnion pin	1	CG-T020	CG-T025	CG-T032	CG-T040	CG-T050	CG-T063	—	—	Trunnion pin x 2, Trunnion pivot bracket x 2, Flat washer x 2
Clevis	1	CG-D020	CG-D025	CG-D032	CG-D040	CG-D050	CG-D063	CG-D080	CG-D100	Clevis x 1, Bracket mounting bolt x 4, Clevis pin x 1, Retaining ring x 2
Pivot bracket	1	CG-020-24A	CG-025-24A	CG-032-24A	CG-040-24A	CG-050-24A	CG-063-24A	CG-080-24A	CG-100-24A	Pivot bracket x 1

Note) Order two foot brackets per cylinder.

Weight

		Bore size (mm)								(mm)
		20	25	32	40	50	63	80	100	
Basic weight	Basic style	0.11	0.18	0.28	0.44	0.83	1.17	2.23	3.43	
	Axial foot style	0.22	0.31	0.44	0.66	1.31	1.89	3.19	5.18	
	Flange style	0.19	0.28	0.42	0.64	1.17	1.67	2.94	4.78	
	Trunnion style	0.12	0.20	0.31	0.49	0.97	1.31	—	—	
	Clevis style	0.16	0.26	0.43	0.67	1.23	1.85	2.94	4.71	
Pivot bracket		0.08	0.09	0.17	0.25	0.44	0.80	0.98	1.75	
Single knuckle joint		0.05	0.09	0.09	0.10	0.22	0.22	0.39	0.57	
Double knuckle joint (With pin)		0.05	0.09	0.09	0.13	0.26	0.26	0.64	1.31	
Additional weight per each 50 mm of stroke		0.05	0.07	0.09	0.15	0.22	0.26	0.35	0.49	

Calculation: (Example) **CG1YL20-100**

(Foot style, ø20, 100 st)

- Basic weight..... 0.22 (Foot, ø20)
- Additional weight..... 0.05/50 stroke
- Cylinder stroke..... 100 stroke
- $0.22 + 0.05 \times 100/50 = 0.32$ kg

Mounting Procedure

Mounting procedure for trunnion

Follow the procedures below when mounting a pivot bracket on the trunnion.

ø20 to ø63

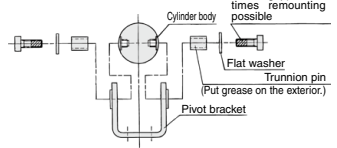

Mounting procedure for clevis

Follow the procedures below when mounting a pivot bracket on the clevis style.

ø20 to ø63

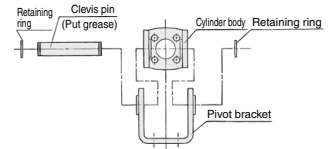

ø80, ø100

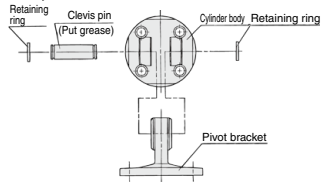

⚠ Precautions

Be sure to read before handling.

Refer to front matter 39 for Safety Instructions and pages 3 to 12 for Actuator and Auto Switch Precautions.

Operating Precautions

⚠ Warning

1. Operate within the specified cylinder speed.
Otherwise, cylinder and seal damage may occur.
2. When operating a cylinder as a single side fixed (Basic/flange style), a bending moment generated at the stroke end due to vibration will be applied to the cylinder, which may damage it. In such cases, install a bracket to prevent vibration or lower the piston speed until the cylinder does not vibrate at the stroke end.

⚠ Caution

1. Tighten clevis bracket mounting bolts with the proper tightening torque shown listed below.
ø20: 1.5 N·m, ø25 to 32: 2.9 N·m, ø40: 4.9 N·m,
ø50: 11.8 N·m, ø63 to 80: 24.5 N·m, ø100: 42.2 N·m

Disassembly/Replacement

⚠ Caution

1. Do not replace the bushings.
The bushings are press-fit. To replace them, they must be replaced together with the cover assembly.
2. To replace a seal, apply grease to the new seal before installing it.
If the cylinder is put into operation without applying grease to the seal, it could cause the seal to wear significantly, leading to premature air leakage.
3. Those with a bore of ø50 or more cannot be disassembled.
When disassembling cylinders with bore sizes of ø20 through ø40, grip the double flat part of either the head cover or the rod cover with a vise and loosen the other side with a wrench or a monkey wrench, etc., and then remove the cover. When re-tightening, tighten approximately 2 degrees more than the original position. (Cylinders with ø50 or larger bore sizes are tightened with a large tightening torque and cannot be disassembled. Please contact SMC when disassembly is required.)

REA

REB

REC

COY

COX

MQ

RHC

RZQ

D-□

-X□

Series CG1Y

Dimensions: $\varnothing 20$ to $\varnothing 100$

Basic style: CG1YB

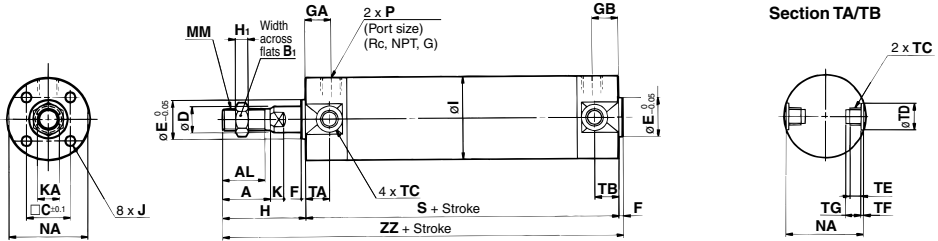

Section TA/TB

(mm)

Bore size (mm)	TC*	TDH9	TE	TF	TG
20	M5 x 0.8	8 ^{+0.08} ₀	4	0.5	5.5
25	M6 x 0.75	10 ^{+0.08} ₀	5	1	6.5
32	M8 x 1.0	12 ^{+0.08} ₀	5.5	1	7.5
40	M10 x 1.25	14 ^{+0.08} ₀	6	1.25	8.5
50	M12 x 1.25	16 ^{+0.08} ₀	7.5	2	10
63	M14 x 1.5	18 ^{+0.08} ₀	11.5	3	14.5

* Trunnion mounting taps for the width across flats NA are not attached to $\varnothing 80$ and $\varnothing 100$ types.

(mm)

Bore size (mm)	Stroke range (mm)	A	AL	B1	C	D	E	F	H	H1	I	J	K	KA	MM	NA
20	Up to 200	18	15.5	13	14	8	12	2	35	5	26	M4 x 0.7 depth 7	5	6	M8 x 1.25	24
25	Up to 300	22	19.5	17	16.5	10	14	2	40	6	31	M5 x 0.8 depth 7.5	5.5	8	M10 x 1.25	29
32	Up to 300	22	19.5	17	20	12	18	2	40	6	38	M5 x 0.8 depth 8	5.5	10	M10 x 1.25	35.5
40	Up to 300	30	27	19	26	16	25	2	50	8	47	M6 x 1 depth 12	6	14	M14 x 1.5	44
50	Up to 300	35	32	27	32	20	30	2	58	11	58	M8 x 1.25 depth 16	7	18	M18 x 1.5	55
63	Up to 300	35	32	27	38	20	32	2	58	11	72	M10 x 1.5 depth 16	7	18	M18 x 1.5	69
80	Up to 300	40	37	32	50	25	40	3	71	13	89	M10 x 1.5 depth 22	10	22	M22 x 1.5	80
100	Up to 300	40	37	41	60	30	50	3	71	16	110	M12 x 1.75 depth 22	10	26	M26 x 1.5	100

(mm)

Bore size (mm)	Stroke range (mm)	S	TA	TB	ZZ	Rc, NPT port			G port		
						GA	GB	P	GA	GB	P
20	Up to 200	77	11	11	114	12	12	1/8	12	12	M5 x 0.8
25	Up to 300	77	11	11	119	12	12	1/8	12	12	M5 x 0.8
32	Up to 300	79	11	11	121	12	12	1/8	10	10	1/8
40	Up to 300	87	12	12	139	13	13	1/8	10	10	1/8
50	Up to 300	102	13	13	162	14	14	1/4	12	12	1/4
63	Up to 300	102	13	13	162	14	14	1/4	12	12	1/4
80	Up to 300	122	—	—	196	20	20	3/8	17	17	3/8
100	Up to 300	122	—	—	196	20	20	1/2	17	17	1/2

With Mounting Bracket

Axial foot style: CG1YL

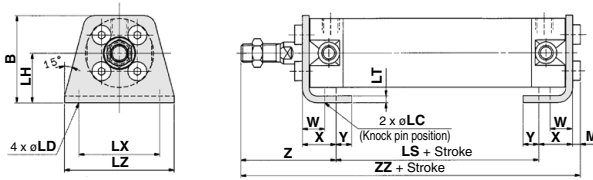

Axial Foot Style

Bore size (mm)	B	LC	LD	LH	LS	LT	LX	LZ	M	W	X	Y	Z	ZZ	(mm)
20	34	4	6	20	53	3	32	44	3	10	15	7	47	118	
25	38.5	4	6	22	53	3	36	49	3.5	10	15	7	52	123.5	
32	45	4	7	25	53	3	44	58	3.5	10	16	8	53	125.5	
40	54.5	4	7	30	60	3	54	71	4	10	16.5	8.5	63.5	144	
50	70.5	5	10	40	67	4.5	66	86	5	17.5	22	11	75.5	169.5	
63	82.5	5	12	45	67	4.5	82	106	5	17.5	22	13	75.5	169.5	
80	101	6	11	55	74	4.5	100	125	5	20	28.5	14	95	202.5	
100	121	6	14	65	74	6	120	150	7	20	30	16	95	206	

* Other dimensions are the same as basic style.

Rod side flange style: CG1YF

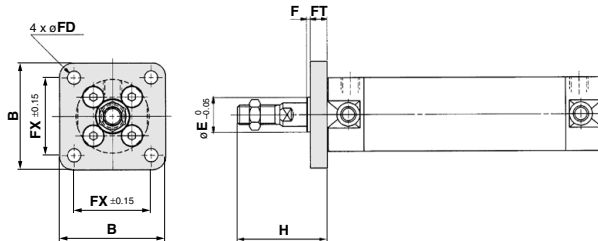

Head side flange style: CG1YG

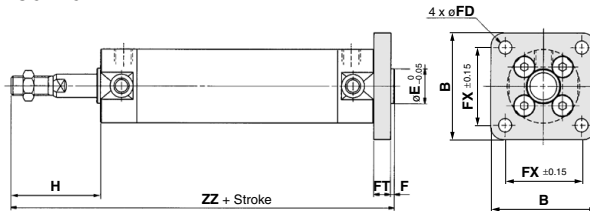

Flange Style

Bore size (mm)	B	E	F	FX	FD	FT	H	Head side flange ZZ
20	40	12	2	28	5.5	6	35	120
25	44	14	2	32	5.5	7	40	126
32	53	18	2	38	6.6	7	40	128
40	61	25	2	46	6.6	8	50	147
50	76	30	2	58	9	9	58	171
63	92	32	2	70	11	9	58	171
80	104	40	3	82	11	11	71	207
100	128	50	3	100	14	14	71	210

Note) End boss is machined on the flange for øE.

* Other dimensions are the same as basic style.

- REA
- REB
- REC
- CY
- CX
- MQ
- RHC
- RZQ

- D
- X

Series CG1Y

With Mounting Bracket

Rod side trunnion style: CG1YU

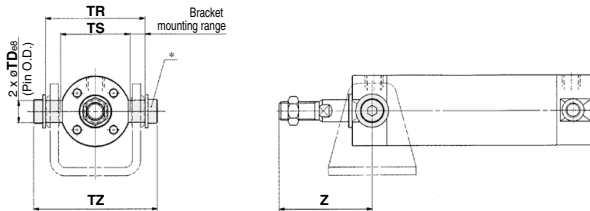

Trunnion Style

(mm)

Bore size (mm)	TDe8	TR	TS
20	8 $\begin{smallmatrix} -0.025 \\ -0.045 \end{smallmatrix}$	39	28
25	10 $\begin{smallmatrix} -0.025 \\ -0.047 \end{smallmatrix}$	43	33
32	12 $\begin{smallmatrix} -0.025 \\ -0.055 \end{smallmatrix}$	54.5	40
40	14 $\begin{smallmatrix} -0.025 \\ -0.055 \end{smallmatrix}$	65.5	49
50	16 $\begin{smallmatrix} -0.025 \\ -0.055 \end{smallmatrix}$	80	60
63	18 $\begin{smallmatrix} -0.025 \\ -0.055 \end{smallmatrix}$	9	74

Head side trunnion style: CG1YT

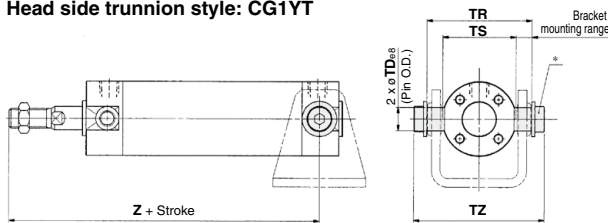

Bore size (mm)	TZ	Rod side	Head side
		Z	Z
20	47.6	46	101
25	53	51	106
32	67.7	51	108
40	78.7	62	125
50	98.6	71	147
63	119.2	71	147

* Consists of trunnion pin, flat washer and hexagon socket head cap bolt.
 (Note) Refer to page 1209 for pivot bracket.

* Other dimensions are the same as basic style.

Clevis style: CG1YD

ø20 to ø63

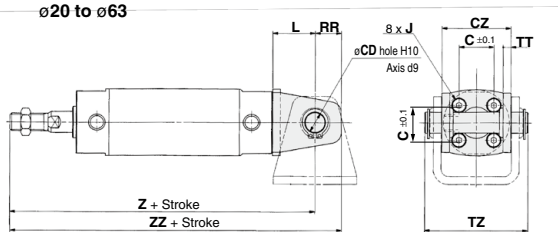

(The above shows the case port location is changed by 90°.)

ø80, ø100

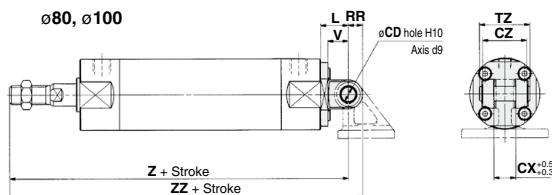

Clevis Style

(mm)

Bore size (mm)	CD	CX	CZ	L	RR	V
20	8	—	29	14	11	—
25	10	—	33	16	13	—
32	12	—	40	20	15	—
40	14	—	49	22	18	—
50	16	—	60	25	20	—
63	18	—	74	30	22	—
80	18	28	56	35	18	26
100	22	32	64	43	22	32

Bore size (mm)	TZ	Z	ZZ	Applicable pin part no.
20	43.4	126	137	CD-G02
25	48	133	146	CD-G25
32	59.4	139	154	CD-G03
40	71.4	159	177	CD-G04
50	86	185	205	CD-G05
63	105.4	190	212	CD-G06
80	64	228	246	IY-G08
100	72	236	258	IY-G10

(Note) Refer to page 1209 for pivot bracket.

* Other dimensions are the same as basic style.

* Clevis pin and retaining ring are attached for the clevis style.

Accessory Bracket Dimensions

Single Knuckle Joint

I-G02/G03

Material: Rolled steel

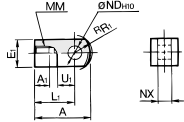

I-G04/G05/G08/G10

Material: Cast iron

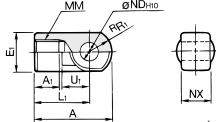

Part no.	Applicable bore (mm)	A	A _t	E _t	L ₁	MM	R _{r1}	U ₁	N _D	N _D mm	NX
I-G02	20	34	8.5	□16	25	M8 x 1.25	10.3	11.5	8	8 ^{-0.008} _{-0.4}	8 ^{-0.2} _{-0.4}
I-G03	25, 32	41	10.5	□20	30	M10 x 1.25	12.8	14	10	10 ^{-0.008} _{-0.4}	10 ^{-0.2} _{-0.4}
I-G04	40	42	14	□22	30	M14 x 1.5	12	14	10	10 ^{-0.008} _{-0.3}	18 ^{-0.3} _{-0.3}
I-G05	50, 63	56	18	□28	40	M18 x 1.5	16	20	14	10 ^{-0.070} _{-0.3}	22 ^{-0.3} _{-0.3}
I-G08	80	71	21	□38	50	M22 x 1.5	21	27	18	18 ^{-0.070} _{-0.3}	28 ^{-0.3} _{-0.3}
I-G10	100	79	21	□44	55	M26 x 1.5	24	31	22	22 ^{-0.084} _{-0.3}	32 ^{-0.3} _{-0.3}

Knuckle Pin

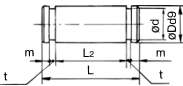

Material: Carbon steel

Part no.	Applicable bore (mm)	Dd9	L	d	L ₂	m	t	Applicable retaining ring
IV-G02	20	8 ^{-0.040} _{-0.070}	21	7.6	16.2	1.5	0.9	Type C 8 for axis
IV-G03	25, 32	10 ^{-0.040} _{-0.070}	25.6	9.6	20.2	1.55	1.15	Type C 10 for axis
IV-G04	40	10 ^{-0.040} _{-0.070}	41.6	9.6	36.2	1.55	1.15	Type C 10 for axis
IV-G05	50, 63	14 ^{-0.050} _{-0.080}	50.6	13.4	44.2	2.05	1.15	Type C 14 for axis
IV-G08	80	18 ^{-0.050} _{-0.080}	64	17	56.2	2.55	1.35	Type C 18 for axis
IV-G10	100	22 ^{-0.050} _{-0.080}	72	21	64.2	2.55	1.35	Type C 22 for axis

* Retaining rings are shipped together.

Clevis Pin

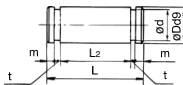

Material: Carbon steel

Part no.	Applicable bore (mm)	Dd9	L	d	L ₂	m	t	Applicable retaining ring
CD-G02	20	8 ^{-0.040} _{-0.070}	43.4	7.6	38.6	1.5	0.9	Type C 8 for axis
CD-G25	25	10 ^{-0.040} _{-0.070}	48	9.6	42.6	1.55	1.15	Type C 10 for axis
CD-G03	32	12 ^{-0.050} _{-0.080}	59.4	11.5	54	1.55	1.15	Type C 12 for axis
CD-G04	40	14 ^{-0.050} _{-0.080}	71.4	13.4	65	2.05	1.15	Type C 14 for axis
CD-G05	50	16 ^{-0.050} _{-0.080}	86	15.2	79.6	2.05	1.15	Type C 18 for axis
CD-G06	63	18 ^{-0.050} _{-0.080}	105.4	17	97.8	2.45	1.35	Type C 18 for axis

* Retaining rings are shipped together.

* Clevis pin and knuckle pin are common for bore size ø80 and ø100.

Rod End Nut

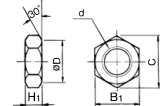

Material: Rolled steel

Part no.	Applicable bore (mm)	d	H ₁	B ₁	C	D
NT-02	20	M8 x 1.25	5	13	(15)	12.5
NT-03	25, 32	M10 x 1.25	6	17	(19.6)	16.5
NT-G04	40	M14 x 1.5	8	19	(21.9)	18
NT-05	50, 63	M18 x 1.5	11	27	(31.2)	26
NT-08	80	M22 x 1.5	13	32	(37.0)	31
NT-10	100	M26 x 1.5	16	41	(47.3)	39

Double Knuckle Joint

Y-G02/G03

Material: Rolled steel

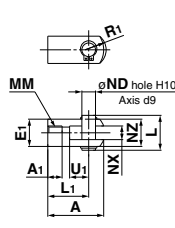

Y-G04/G05/G08/G10

Material: Cast iron

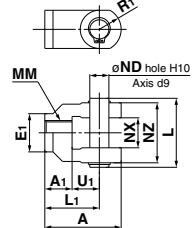

Part no.	Applicable bore (mm)	A	A _t	E _t	L ₁	MM	R ₁	U ₁	ND	NX	NZ	L	Applicable pin part no.
Y-G02	20	34	8.5	□16	25	M8 x 1.25	10.3	11.5	8	8 ^{-0.2} _{-0.4}	16	21	IV-G02
Y-G03	25, 32	41	10.5	□20	30	M10 x 1.25	12.8	14	10	10 ^{-0.008} _{-0.4}	20	25.6	IV-G03
Y-G04	40	42	16	□22	30	M14 x 1.5	12	14	10	18 ^{-0.3} _{-0.3}	36	41.6	IV-G04
Y-G05	50, 63	56	20	□28	40	M18 x 1.5	16	20	14	22 ^{-0.3} _{-0.3}	44	50.6	IV-G05
Y-G08	80	71	23	□38	50	M22 x 1.5	21	27	18	28 ^{-0.3} _{-0.3}	56	64	IV-G08
Y-G10	100	79	24	□44	55	M26 x 1.5	24	31	22	32 ^{-0.3} _{-0.3}	64	72	IV-G10

* Knuckle pin and retaining ring are shipped together.

Pivot Bracket (Order separately)

ø20 to ø63

Material:

Rolled steel

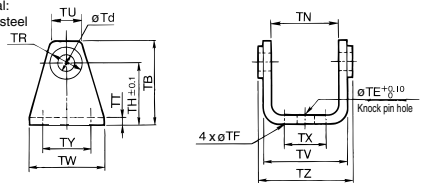

ø80, ø100

Material: Cast iron

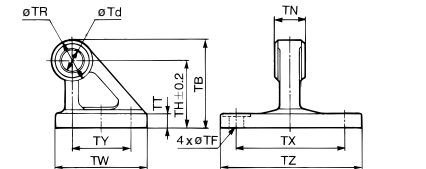

Part no.	Applicable bore (mm)	TB	Td	TE	TF	TH	TN	TR	TT
CG-020-24A	20	36	8	10	5.5	25	(29.3)	13	3.2
CG-025-24A	25	43	10	10	5.5	30	(33.1)	15	3.2
CG-032-24A	32	50	12	10	6.6	35	(40.4)	17	4.5
CG-040-24A	40	58	14	10	6.6	40	(49.2)	21	4.5
CG-050-24A	50	70	16	20	9	50	(60.4)	24	6
CG-063-24A	63	82	18	20	11	60	(74.6)	26	8
CG-080-24A	80	73	18	—	11	55	28	36	11
CG-100-24A	100	90	22	—	13.5	65	32	50	12

Part no.	Applicable bore (mm)	TU	TV	TW	TX	TY	TZ	Applicable pin O.D.
CG-020-24A	20	(18.1)	(35.8)	42	16	28	38.3	8d _a ^{-0.040} _{-0.070}
CG-025-24A	25	(20.7)	(39.8)	42	20	28	42.1	10d _a ^{-0.040} _{-0.070}
CG-032-24A	32	(23.6)	(49.4)	48	22	28	53.8	12d _a ^{-0.050} _{-0.080}
CG-040-24A	40	(27.3)	(58.4)	56	30	30	64.6	14d _a ^{-0.050} _{-0.080}
CG-050-24A	50	(29.7)	(72.4)	64	36	36	79.2	16d _a ^{-0.050} _{-0.080}
CG-063-24A	63	(34.3)	(90.4)	74	46	46	97.2	18d _a ^{-0.050} _{-0.080}
CG-080-24A	80	—	—	72	85	45	110	18d _a ^{-0.050} _{-0.080}
CG-100-24A	100	—	—	93	100	60	130	22d _a ^{-0.060} _{-0.090}

REA

REB

REC

CDY

CDX

MQ

RHC

RZQ

D-□

X-□

Auto Switch Mounting 1

Auto Switch Proper Mounting Position (Detection at Stroke End) and Its Mounting Height

Reed auto switch

D-A9□
 ø20 to ø63

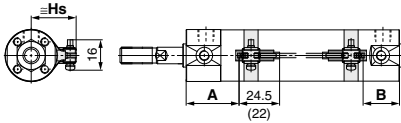

(): Values for D-A96

A and B are the dimensions from the end of the head cover/rod cover to the end of the auto switch.

D-C7, C8

ø20 to ø63

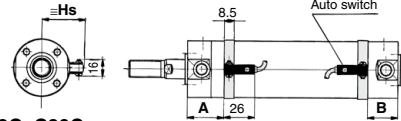

D-C73C, C80C

ø20 to ø63

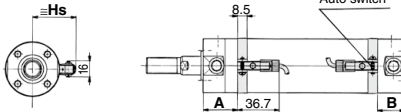

D-B5, B6, B59W

ø20 to ø100

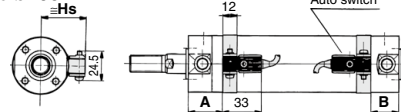

Solid state auto switch

D-M9□
D-M9□W
 ø20 to ø63

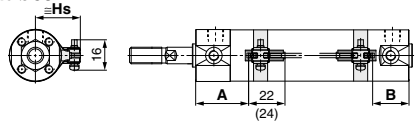

(): Values for D-M9□A

A and B are the dimensions from the end of the head cover/rod cover to the end of the auto switch.

D-G5, K5, G5□W

D-K59W, D-G59F, D-G5NT

ø20 to ø100

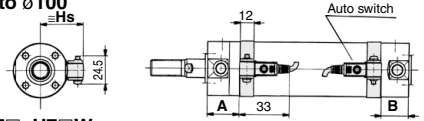

D-H7□, H7□W

D-H7NF

ø20 to ø63

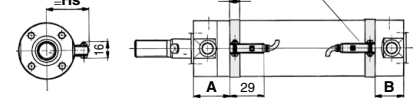

D-H7C

ø20 to ø63

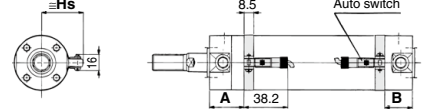

Auto Switch Proper Mounting Position

(mm) Auto Switch Mounting Height

Auto switch model	Auto switch proper mounting position (mm)													
	D-A9□ (V)		D-M9□ (V) D-M9□W (V) D-M9□A (V)		D-C7/C8 D-C73C D-C80C		D-B5 D-B6		D-B59W		D-H7□ D-H7C D-H7□W D-H7NF		D-G5□W D-K59W D-G59F D-G5 D-K5 D-G5NT	
	A	B	A	B	A	B	A	B	A	B	A	B	A	B
20	29	28	33	32	29.5	28.5	23.5	22.5	26.5	25.5	28.5	27.5	25	24
25	29	28	33	32	29.5	28.5	23.5	22.5	26.5	25.5	28.5	27.5	25	24
32	30	29	34	33	30.5	29.5	24.5	23.5	27.5	26.5	29.5	28.5	26	25
40	35	32	39	36	35.5	32.5	29.5	26.5	32	29.5	34.5	31.5	31	28
50	42	40	46	44	42.5	40.5	36.5	34.5	39.5	37.5	41.5	39.5	38	36
63	42	40	46	44	42.5	40.5	36.5	34.5	39.5	37.5	41.5	39.5	38	36
80	—	—	—	—	—	—	46.5	44.5	49.5	47.5	—	—	48	46
100	—	—	—	—	—	—	46.5	44.5	49.5	47.5	—	—	48	46

Auto switch model	Auto switch mounting height (mm)				
	D-M9□ (V) D-M9□W (V) D-M9□A (V) D-A9□ (V)		D-M9□ D-M9□W D-M9□A D-A9□ D-H7□ D-H7□W D-H7NF D-C7/C8	D-C73C D-C80C	D-B5/B6 D-K59W D-B59W D-G5/K5 D-G59F D-G5□W D-H7C
	Hs	Hs	Hs	Hs	
20	25.5	24.5	27	27.5	
25	28	27	29.5	30	
32	31.5	30.5	33	33.5	
40	36	35	37.5	38	
50	41.5	40.5	43	43.5	
63	48.5	47.5	50	50.5	
80	—	—	—	59	
100	—	—	—	69.5	

Note) Adjust the auto switch after confirming the operating conditions in the actual setting.

Minimum Auto Switch Mounting Stroke

Auto switch model	(mm)				
	1 pc.	No. of auto switch mounted			
		2 pcs.		n pcs.	
		Different surfaces	Same surface	Different surfaces	Same surface
D-M9□	5	15 <small>Note 1</small>	40 <small>Note 1</small>	$20 + 35 \frac{(n-2)}{2}$ <small>(n=2, 4, 6...)</small> <small>Note 3</small>	$55 + 35(n-2)$ <small>(n=2, 3, 4, 5...)</small>
D-M9□W	10	15 <small>Note 1</small>	40 <small>Note 1</small>	$20 + 35 \frac{(n-2)}{2}$ <small>(n=2, 4, 6...)</small> <small>Note 3</small>	$55 + 35(n-2)$ <small>(n=2, 3, 4, 5...)</small>
D-M9□A	10	25	40 <small>Note 1</small>	$25 + 35 \frac{(n-2)}{2}$ <small>(n=2, 4, 6...)</small> <small>Note 3</small>	$60 + 35(n-2)$ <small>(n=2, 3, 4, 5...)</small>
D-A9□	5	15	30 <small>Note 1</small>	$15 + 35 \frac{(n-2)}{2}$ <small>(n=2, 4, 6...)</small> <small>Note 3</small>	$50 + 35(n-2)$ <small>(n=2, 3, 4, 5...)</small>
D-M9□V	5	20	35	$20 + 35 \frac{(n-2)}{2}$ <small>(n=2, 4, 6...)</small> <small>Note 3</small>	$35 + 35(n-2)$ <small>(n=2, 3, 4, 5...)</small>
D-A9□V	5	15	25	$15 + 35 \frac{(n-2)}{2}$ <small>(n=2, 4, 6...)</small> <small>Note 3</small>	$25 + 35(n-2)$ <small>(n=2, 3, 4, 5...)</small>
D-M9□WV D-M9□AV	10	20	35	$20 + 35 \frac{(n-2)}{2}$ <small>(n=2, 4, 6...)</small> <small>Note 3</small>	$35 + 35(n-2)$ <small>(n=2, 3, 4, 5...)</small>
D-C7□ D-C80	10	15	50	$15 + 45 \frac{(n-2)}{2}$ <small>(n=2, 4, 6...)</small> <small>Note 3</small>	$50 + 45(n-2)$ <small>(n=2, 3, 4, 5...)</small>
D-H7□ D-H7□W D-H7NF	10	15	60	$15 + 45 \frac{(n-2)}{2}$ <small>(n=2, 4, 6...)</small> <small>Note 3</small>	$60 + 45(n-2)$ <small>(n=2, 3, 4, 5...)</small>
D-C73C D-C80C	10	15	65	$15 + 50 \frac{(n-2)}{2}$ <small>(n=2, 4, 6...)</small> <small>Note 3</small>	$65 + 50(n-2)$ <small>(n=2, 3, 4, 5...)</small>
D-B5□ D-B64 D-G5□ D-K59□	10	15	75	$15 + 50 \frac{(n-2)}{2}$ <small>(n=2, 4, 6...)</small> <small>Note 3</small>	$75 + 55(n-2)$ <small>(n=2, 3, 4, 5...)</small>
D-B59W	15	20	75	$20 + 50 \frac{(n-2)}{2}$ <small>(n=2, 4, 6...)</small> <small>Note 3</small>	$75 + 55(n-2)$ <small>(n=2, 3, 4, 5...)</small>

Note 3) When "n" is an odd number, an even number that is one larger than this odd number is used for the calculation.

Note 1) Auto switch mounting

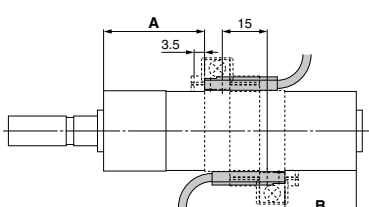
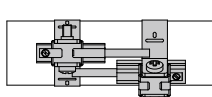
Auto switch model	With 2 auto switches	
	Different surfaces	Same surface
	 <p>Correct auto switch mounting position is 3.5 mm from the back face of the switch holder.</p>	 <p>The auto switch is mounted by slightly displacing it in a direction (cylinder tube circumferential exterior) so that the auto switch and lead wire do not interfere with each other.</p>
D-M9□ D-M9□W	Less than 20 stroke <small>Note 2</small>	Less than 55 stroke <small>Note 2</small>
D-M9□A	Less than 20 stroke <small>Note 2</small>	Less than 60 stroke <small>Note 2</small>
D-A9□	—	Less than 50 stroke <small>Note 2</small>

Note 2) Minimum stroke for mounting auto switches in the other mounting styles mentioned in note 1.

REA

REB

REC

□Y

□X

MQ

RHC

RZQ

D-□

-X□

Auto Switch Mounting 2

Operating Range

Auto switch model	Bore size (mm)							
	20	25	32	40	50	63	80	100
D-A9□ (V)	7	6	8	8	8	9	—	—
D-M9□ (V) D-M9□W (V) D-M9□A (V)	4.5	5	4.5	5.5	5	5.5	—	—
D-C7/C80 D-C73C/C80C	8	10	9	10	10	11	—	—
D-B5□/B64 D-B59W	8	10	9	10	10	11	11	11
D-H7□/H7mW D-H7NF	13	13	14	14	14	17	16	18
D-H7C	4	4	4.5	5	6	6.5	—	—
D-G5□/G5□W/G59F D-G5BA/K59/K59W	7	8.5	9	10	9.5	10.5	—	—
D-G5NT	4	4	4.5	5	6	6.5	6.5	7
D-G5NB	35	40	40	45	45	45	45	50

* Since this is a guideline including hysteresis, not meant to be guaranteed. (Assuming approximately ±30% dispersion)
There may be the case it will vary substantially depending on an ambient environment.

Auto Switch Mounting Bracket Part No.

Auto switch model	Bore size (mm)							
	20	25	32	40	50	63	80	100
D-M9□ (V) D-M9□W (V) D-A9□ (V)	Note 1) BMA3-020	Note 1) BMA3-025	Note 1) BMA3-032	Note 1) BMA3-040	Note 1) BMA3-050	Note 1) BMA3-063	—	—
D-M9□A (V)	Note 2) BMA3-020S	Note 2) BMA3-025S	Note 2) BMA3-032S	Note 2) BMA3-040S	Note 2) BMA3-050S	Note 2) BMA3-063S	—	—
D-C7□/C80 D-C73C D-C80C D-H7□ D-H7□W D-H7NF	BMA2-020A	BMA2-025A	BMA2-032A	BMA2-040A	BMA2-050A	BMA2-063A	—	—
D-B5□/B64 D-B59W D-G5□/K59 D-G5□W/K59W D-G59F D-G5NT D-G5NB	BA-01	BA-02	BA-32	BA-04	BA-05	BA-06	BA-08	BA-10

Note 1) Set part number which includes the auto switch mounting band (BMA2-□□□A) and the holder kit (BJ5-1/Switch bracket: Transparent).

Since the switch bracket (made from nylon) is affected in an environment where alcohol, chloroform, methylamines, hydrochloric acid or sulfuric acid is splashed over, so it cannot be used. Please consult SMC regarding other chemicals.

Note 2) Set part number which includes the auto switch mounting band (BMA2-□□□AS) and the holder kit (BJ4-1/Switch bracket: White).

Note 3) For the D-M9 A (V) type auto switch, do not install the switch bracket on the indicator light.

[Stainless Steel Mounting Screw Kit]

The following set of stainless steel mounting screws is available. Use them in accordance with the operating environment.

(Since auto switch brackets are not included, order them separately.)

BBA3: For D-B5/B6/G5/K5 types

BBA4: For D-C7/C80/H7 types

Note 4) Refer to page 1989 for the details of BBA3 screws.

The above stainless steel screws are used when a cylinder is shipped with D-H7BA type and G5BA type auto switches.





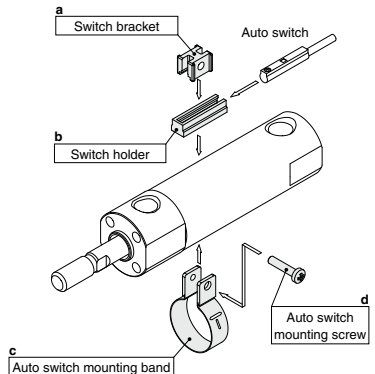

When only a switch is shipped independently, BBA3 screws or BBA4 screws are attached respectively.

- ① BJ□-1: A set of a and b in the figure.
BJ4-1 (Switch bracket: White)
BJ5-1 (Switch bracket: Transparent)
- ② BM2-□□□A (S) : A set of c and d in the figure.
Band (c) is mounted so that the projected part is on the internal side (contact side with the tube).



Cylinder Bracket by Stroke/Auto Switch Mounting Surface

Auto switch mounting surface varies depending on mounting brackets and cylinder strokes. Refer to the table below.

No. of auto switches	Basic style, Foot style, Flange style, Clevis style			Trunnion style		
	1 (Rod cover side)	2 (Different surfaces)	2 (Same surface)	1 (Rod cover side)	2 (Different surfaces)	2 (Same surface)
Switch mounting surface	Port surface 	Port surface 	Port surface 			
Switch type						
D-M9□(V) D-M9□W(V) D-M9□A(V) D-A9□(V)	10 st or more	15 to 44st	45 st or more	10 st or more	15 to 44 st	45 st or more
D-C7/C8	10 st or more	15 to 49st	50 st or more	10 st or more	15 to 49 st	50 st or more
D-H7□/H7□W D-H7NF	10 st or more	15 to 59st	60 st or more	10 st or more	15 to 59 st	60 st or more
D-C73C/C80C/H7C	10 st or more	15 to 64st	65 st or more	10 st or more	15 to 64 st	65 st or more
D-B5/B6/G5/K5 D-G5□W/K59W D-G59F/G5NT	10 st or more	15 to 74st	75 st or more	10 st or more	15 to 74 st	75 st or more
D-B59W	15 st or more	20 to 74st	75 st or more	15 st or more	20 to 74 st	75 st or more

* Trunnion style is not available for bore sizes ø80 and ø100.

Other than the applicable auto switches listed in "How to Order", the following auto switches can be mounted.

For detailed specifications, refer to pages 1893 to 2007.

Auto switch type	Model	Electrical entry (Direction)	Features	Applicable bore size
Solid state	D-H7A1, H7A2, H7B	Grommet (In-line)	—	ø20 to ø63
	D-H7NW, H7PW, H7BW		Diagnostic indication (2-color indication)	
	D-H7BA		Water resistant (2-color indication)	
	D-G5NT		With timer	ø20 to ø100
Reed	D-C73, C76		—	ø20 to ø63
	D-C80		Without indicator light	
	D-B53	—	ø20 to ø100	

* With pre-wired connector is available for solid state auto switches. For details, refer to pages 1960 to 1961.

* Normally closed (NC = b contact), solid state auto switches (D-F9G, F9H type) are also available. For details, refer to page 1911.

* Wide range detection type, solid state auto switches (D-G5NB type) are also available. Refer to page 1953 for details.

REA

REB

REC

□Y

□X

MQ

RHC

RZQ

D-□

-X□

Smooth Cylinder

Series CA2Y

ø40, ø50, ø63, ø80, ø100

How to Order

CA2Y L 40 [] - 150 - []

With auto switch CDA2Y L 40 [] - 150 - M9BW [] []

With auto switch
(Built-in magnet)

Mounting style

B	Basic style
L	Axial foot style
F	Rod side flange style
G	Head side flange style
C	Single clevis style
D	Double clevis style
T	Center trunnion style

Bore size

40	40 mm
50	50 mm
63	63 mm
80	80 mm
100	100 mm

Thread type

Nil	Rc
TN	NPT
TF	G

Number of auto switches

Nil	2 pcs.
S	1 pc.
3	3 pcs.
n	n pcs.

Auto switch

Nil	Without auto switch
-----	---------------------

Cylinder stroke (mm)
Refer to "Standard Stroke" on page 1215.

Made to Order
For details, refer to page 1215.

Built-in Magnet Cylinder Model
If a built-in magnet cylinder without an auto switch is required, there is no need to enter the symbol for the auto switch.
(Example) CDA2YB40-100

Applicable Auto Switches

Refer to pages 1893 to 2007 for further information on auto switches.

Type	Special function	Electrical entry	Wiring (Output)	Load voltage		Auto switch model		Lead wire (m)					Pre-wired connector	Applicable load
				DC	AC	Tie-rod mounting	Band mounting	0.5 (Nil)	1 (M)	3 (L)	5 (Z)			
Solid state auto switch	—	Grommet	3-wire (NPN)	24 V	5 V, 12 V	—	M9N	●	●	●	○	○	IC circuit	Relay, PLC
			3-wire (PNP)				M9P	●	●	●	○	○		
		2-wire	M9B	●	●	●	○	○						
		—	J51	●	●	●	○	○						
	Terminal conduit	Yes	3-wire (NPN)	24 V	12 V	100 V, 200 V	G39C	—	—	—	—	—	IC circuit	
			2-wire				K39C	—	—	—	—	—		
	Diagnostic indication (2-color)	Grommet	3-wire (NPN)	24 V	5 V, 12 V	—	M9NW	●	●	●	○	○	IC circuit	
			3-wire (PNP)				M9PW	●	●	●	○	○		
	Water resistant (2-color indication)	Grommet	2-wire	24 V	12 V	—	M9BW	●	●	●	○	○	—	
			3-wire (NPN)				M9NA***	—	○	○	○	○		
With diagnostic output (2-color)	Grommet	3-wire (PNP)	24 V	5V, 12V	—	M9PA***	—	○	○	●	○	IC circuit		
		2-wire				M9FA***	—	○	○	○	○			
Magnetic field resistant (2-color)	Grommet	4-wire (NPN)	24 V	5 V, 12 V	—	F59F	●	●	●	○	○	IC circuit		
		2-wire (Non-polar)				P3DW	●	—	●	●	○		—	
Reed auto switch	—	Grommet	3-wire (Equiv. NPN)	24 V	5 V	—	A96**	—	●	—	●	—		IC circuit
			2-wire				A93**	—	●	—	●	—	IC circuit	
		Terminal conduit	Yes	2-wire	24 V	12 V	100 V or less	A90**	—	●	—	●		—
								DIN terminal	Yes	2-wire	24 V	100 V, 200 V or less	A54	●
		Diagnostic indication (2-color)	Grommet	2-wire	24 V	100 V, 200 V	A64						●	●
							—	Grommet	2-wire	24 V	100 V, 200 V	A33C	—	—
—	Grommet	2-wire	24 V	100 V, 200 V	A34C	—						—	—	—
					—	Grommet	2-wire	24 V	100 V, 200 V	A44C	—	—	—	
—	Grommet	2-wire	24 V	100 V, 200 V						A59W	●	●	●	—
					—	Grommet	2-wire	24 V	100 V, 200 V	B59W	●	●	●	—

*** Water resistant type auto switches can be mounted on the above models, but in such case SMC cannot guarantee water resistance. Consult with SMC regarding water resistant types with the above model numbers.

* Lead wire length symbols: 0.5 m Nil (Example) M9NW * ○: Manufactured upon receipt of order.
1 m M (Example) M9NWM ** D-A9□/A9□V types cannot be mounted on ø50.
3 m L (Example) M9NWL
5 m Z (Example) M9NWZ

* In addition to the models in the above table, there are some other auto switches that are applicable. For more information, refer to page 1228.
* Refer to pages 1960 and 1961 for details of auto switches with a pre-wired connector. For D-P3DW□, refer to pages 1948 and 1949.
* D-A9□/M9□□/P3DW auto switches are shipped together (not assembled). (Only auto switch mounting brackets are assembled before shipped for D-A9□ and M9□□□.)

Specifications



Bore size (mm)	40	50	63	80	100
Action	Double acting				
Operating piston speed	5 to 500 mm/s				
Fluid	Air				
Proof pressure	1.05 MPa				
Maximum operating pressure	0.7 MPa				
Ambient and fluid temperature	Without auto switch -10 to 70°C (with no freezing)				
	With auto switch -10 to 60°C (with no freezing)				
Cushion	None				
Lubrication	Not required (Non-lube)				
Mounting	Basic, Axial foot, Front flange, Rear flange, Single clevis, Double clevis, Center trunnion				
Allowable leakage rate	0.5 L/min (ANR)				

Symbol

Without cushion



Minimum Operating Pressure

Bore size (mm)	Unit: MPa				
	40	50	63	80	100
Minimum operating pressure	0.02			0.01	

Standard Stroke

Bore size (mm)	Standard stroke (mm)
40	25, 50, 75, 100, 125, 150, 175, 200, 250, 300, 350, 400, 450, 500
50, 63	25, 50, 75, 100, 125, 150, 175, 200, 250, 300, 350, 400, 450, 500, 600
80, 100	25, 50, 75, 100, 125, 150, 175, 200, 250, 300, 350, 400, 450, 500, 600, 700

Note 1) Intermediate strokes not listed above are also available.

Please consult with SMC for strokes outside the above ranges.

Note 2) As the stroke increases, more sliding resistance may result due to the deflection of the piston rod and other factors. Take measures such as the installation of a guide.



Made to Order

(For details, refer to pages 2009 to 2152.)

Symbol	Specifications
-XA □	Change of rod end shape
-XC6	Made of stainless steel
-XC7	Tie-rod, cushion valve and tie-rod nut made of stainless steel
-XC9	Adjustable stroke cylinder/adjustable retraction type
-XC14	Change of trunnion bracket mounting position
-XC15	Change of tie-rod length
-XC27	Double clevis and double knuckle joint pins made of stainless steel
-XC28	Compact flange made of SS400
-XC29	Double knuckle joint with spring pin
-XC30	Rod side trunnion
-XC65	-XC6 + -XC7

Accessory

Mounting		Basic	Foot	Front flange	Rear flange	Single clevis	Double clevis	Center trunnion
Standard	Rod end nut	●	●	●	●	●	●	●
	Clevis pin	—	—	—	—	—	●	—
Option	Single knuckle joint	●	●	●	●	●	●	—
	Double knuckle joint (with pin)	●	●	●	●	●	●	●

Replacement Parts: Seal Kit

Bore size (mm)	Kit no.	Contents
40	CA2Y40-PS	Rod seal 1 pc.
50	CA2Y50-PS	Piston seal 1 pc.
63	CA2Y63-PS	Cylinder tube gasket 2 pcs.
80	CA2Y80-PS	Grease pack (10 g) 1 pc.
100	CA2Y100-PS	

When only grease for maintenance is necessary, please order by the following part numbers.

Grease pack part no.: GR-L-005 (5 g)

GR-L-010 (10 g)

GR-L-150 (150 g)

REA

REB

REC

COY

COX

MQ

RHC

RZQ

D-□

-X□

Series CA2Y

Weight

(kg)

Bore size (mm)		40	50	63	80	100
Basic weight	Basic style	0.89	1.36	2.00	3.48	4.87
	Axial foot style	1.08	1.58	2.34	4.15	5.86
	Flange style	1.26	1.81	2.79	4.93	6.79
	Single clevis style	1.12	1.70	2.63	4.59	6.65
	Double clevis style	1.16	1.79	2.79	4.88	7.17
	Trunnion style	1.25	1.84	2.80	5.03	7.15
Additional weight per each 50 mm of stroke		0.22	0.28	0.37	0.52	0.65
Accessory	Single knuckle	0.23	0.26	0.26	0.60	0.83
	Double knuckle (With pin)	0.37	0.43	0.43	0.87	1.27

Calculation: (Example) CA2YL40-100/Axial foot

- Basic weight.....1.08 kg
 - Additional weight.....0.22/50 stroke
 - Cylinder stroke.....100 stroke
- $$1.08 + 0.22 \times 100/50 = 1.52 \text{ kg}$$

Low Friction Cylinder Mounting (Accessory)

CDA2Y - - X1854

Same mounting specification as CDA2Q

In order to adjust the mounting dimensions of the low friction cylinder (CDA2Q), extend the longitudinal dimension (S, ZZ) by 10 mm.

* Cylinders without a built-in magnet can be interchangeable.

Dimensions

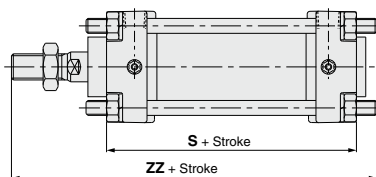

Bore size (mm)	S	ZZ
40	94	156
50	100	169
63	108	180
80	126	214
100	136	225

* Add 10 mm to S and ZZ dimensions of the double acting, single rod type on pages 1217 to 1221 for the dimensions for each mounting bracket other than the basic style.

Dimensions: $\varnothing 40$ to $\varnothing 100$

Basic style: CA2YB

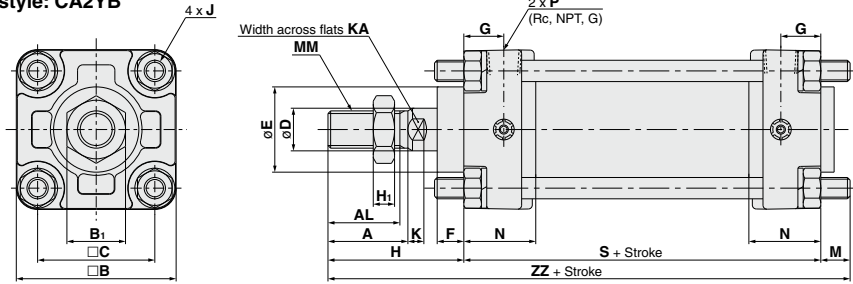

Bore size (mm)	Stroke range	A	AL	\square B	B ₁	\square C	D	E	F	G	H	H ₁	J	K	KA	M	MM	N	P	S	ZZ
40	Up to 500	30	27	60	22	44	16	32	10	15	51	8	M8 x 1.25	6	14	11	M14 x 1.5	27	1/4	84	146
50	Up to 600	35	32	70	27	52	20	40	10	17	58	11	M8 x 1.25	7	18	11	M18 x 1.5	30	3/8	90	159
63	Up to 600	35	32	85	27	64	20	40	10	17	58	11	M10 x 1.25	7	18	14	M18 x 1.5	31	3/8	98	170
80	Up to 700	40	37	102	32	78	25	52	14	21	71	13	M12 x 1.75	10	22	17	M22 x 1.5	37	1/2	116	204
100	Up to 700	40	37	116	41	92	30	52	14	21	72	16	M12 x 1.75	10	26	17	M26 x 1.5	40	1/2	126	215

Axial foot: CA2YL

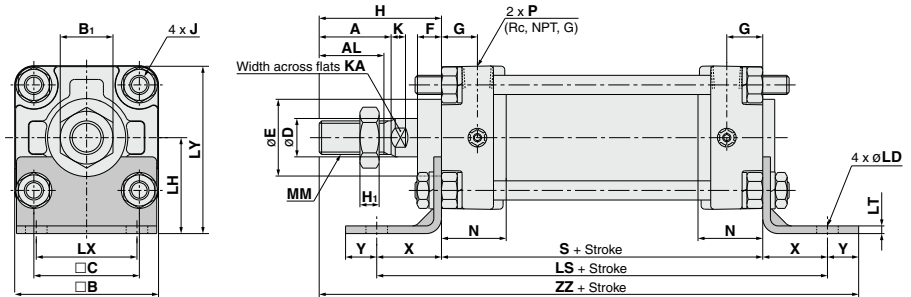

Bore size (mm)	A	AL	B	B ₁	C	D	E	F	G	H ₁	J	K	KA	LD	LH	LS	LT	LX	LY
40	30	27	60	22	44	16	32	10	15	8	M8 x 1.25	6	14	9.0	40	138	3.2	42	70
50	35	32	70	27	52	20	40	10	17	11	M8 x 1.25	7	18	9.0	45	144	3.2	50	80
63	35	32	85	27	64	20	40	10	17	11	M10 x 1.25	7	18	11.5	50	166	3.2	59	93
80	40	37	102	32	78	25	52	14	21	13	M12 x 1.75	10	22	13.5	65	204	4.5	76	116
100	40	37	116	41	92	30	52	14	21	16	M12 x 1.75	10	26	13.5	75	212	6.0	92	133

Bore size (mm)	MM	N	P	S	X	Y	H	ZZ
40	M14 x 1.5	27	1/4	84	27	13	51	175
50	M18 x 1.5	30	3/8	90	27	13	58	188
63	M18 x 1.5	31	3/8	98	34	16	58	206
80	M22 x 1.5	37	1/2	116	44	16	71	247
100	M26 x 1.5	40	1/2	126	43	17	72	258

- REA
- REB
- REC
- CQY
- CQX
- MQ
- RHC
- RZQ

- D-
- X

Series CA2Y

Rod Side Flange Style: CA2YF

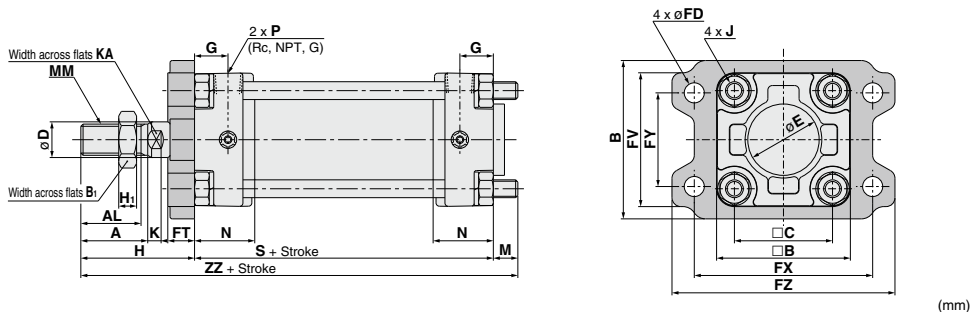

Bore size (mm)	A	AL	FB	B	B ₁	C	D	E	FV	FD	FT	FX	FY	FZ	G	H ₁	J	K	KA	M	MM
40	30	27	71	60	22	44	16	32	60	9.0	12	80	42	100	15	8	M8 x 1.25	6	14	11	M14 x 1.5
50	35	32	81	70	27	52	20	40	70	9.0	12	90	50	110	17	11	M8 x 1.25	7	18	11	M18 x 1.5
63	35	32	101	85	27	64	20	40	86	11.5	15	105	59	130	17	11	M10 x 1.25	7	18	14	M18 x 1.5
80	40	37	119	102	32	78	25	52	102	13.5	18	130	76	160	21	13	M12 x 1.75	10	22	17	M22 x 1.5
100	40	37	133	116	41	92	30	52	116	13.5	18	150	92	180	21	16	M12 x 1.75	10	26	17	M26 x 1.5

Bore size (mm)	N	P	S	H	ZZ
40	27	1/4	84	51	146
50	30	3/8	90	58	159
63	31	3/8	98	58	170
80	37	1/2	116	71	204
100	40	1/2	126	72	215

Head Side Flange Style: CA2YG

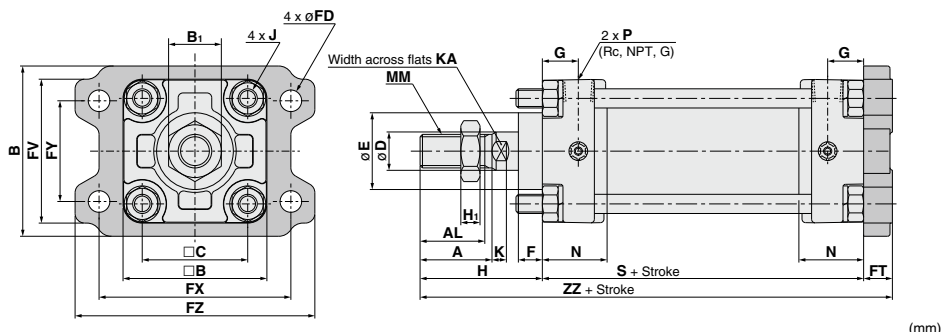

Bore size (mm)	A	AL	FB	B	B ₁	C	D	E	F	FV	FD	FT	FX	FY	FZ	G	H ₁	J	K	KA
40	30	27	71	60	22	44	16	32	10	60	9.0	12	80	42	100	15	8	M8 x 1.25	6	14
50	35	32	81	70	27	52	20	40	10	70	9.0	12	90	50	110	17	11	M8 x 1.25	7	18
63	35	32	101	85	27	64	20	40	10	86	11.5	15	105	59	130	17	11	M10 x 1.25	7	18
80	40	37	119	102	32	78	25	52	14	102	13.5	18	130	76	160	21	13	M12 x 1.75	10	22
100	40	37	133	116	41	92	30	52	14	116	13.5	18	150	92	180	21	16	M12 x 1.75	10	26

Bore size (mm)	MM	N	P	S	H	ZZ
40	M14 x 1.5	27	1/4	84	51	147
50	M18 x 1.5	30	3/8	90	58	160
63	M18 x 1.5	31	3/8	98	58	171
80	M22 x 1.5	37	1/2	116	71	205
100	M26 x 1.5	40	1/2	126	72	216

Single Clevis Style: CA2YC

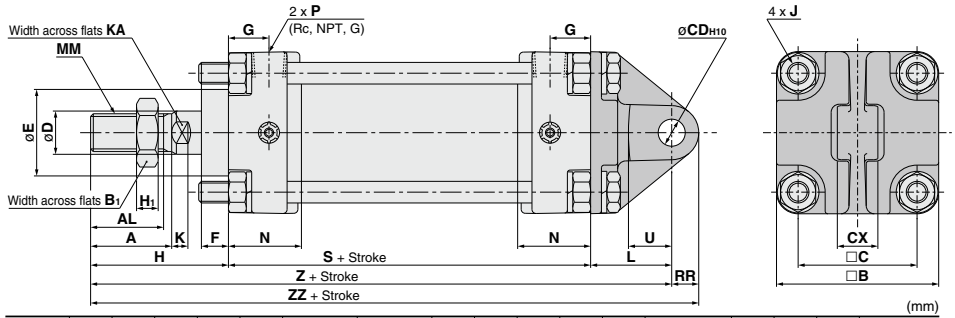

Bore size (mm)	A	AL	B	B ₁	C	CD ^{H10}	CX	D	E	F	G	H ₁	J	K	KA	L	MM
40	30	27	60	22	44	10 ^{+0.058} ₀	15.0 ^{-0.1} _{-0.3}	16	32	10	15	8	M8 x 1.25	6	14	30	M14 x 1.5
50	35	32	70	27	52	12 ^{+0.070} ₀	18.0 ^{-0.1} _{-0.3}	20	40	10	17	11	M8 x 1.25	7	18	35	M18 x 1.5
63	35	32	85	27	64	16 ^{+0.070} ₀	25.0 ^{-0.1} _{-0.3}	20	40	10	17	11	M10 x 1.25	7	18	40	M18 x 1.5
80	40	37	102	32	78	20 ^{+0.084} ₀	31.5 ^{-0.1} _{-0.3}	25	52	14	21	13	M12 x 1.75	10	22	48	M22 x 1.5
100	40	37	116	41	92	25 ^{+0.084} ₀	35.5 ^{-0.1} _{-0.3}	30	52	14	21	16	M12 x 1.75	10	26	58	M26 x 1.5

Bore size (mm)	N	P	RR	S	U	H	Z	ZZ
40	27	1/4	10	84	16	51	165	175
50	30	3/8	12	90	19	58	183	195
63	31	3/8	16	98	23	58	196	212
80	37	1/2	20	116	28	71	235	255
100	40	1/2	25	126	36	72	256	281

Double Clevis Style: CA2YD

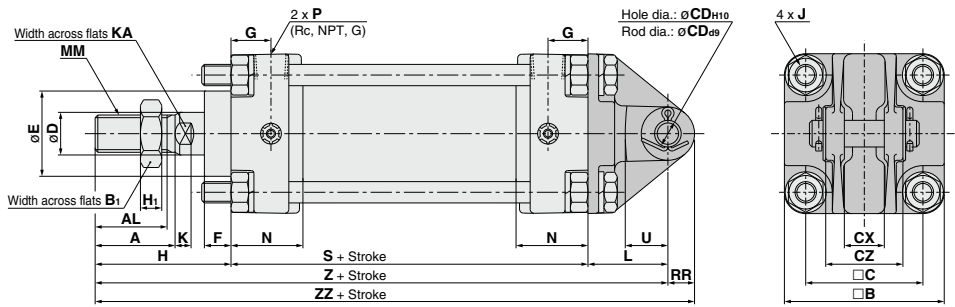

* Double clevis pins, double knuckle pins and retaining rings are shipped together.

Bore size (mm)	A	AL	B	B ₁	C	CD	CX	CZ	D	E	F	G	H ₁	J	K	KA	L	MM
40	30	27	60	22	44	10 ^{+0.058} ₀	15.0 ^{+0.3} _{-0.1}	29.5	16	32	10	15	8	M8 x 1.25	6	14	30	M14 x 1.5
50	35	32	70	27	52	12 ^{+0.070} ₀	18.0 ^{+0.3} _{-0.1}	38	20	40	10	17	11	M8 x 1.25	7	18	35	M18 x 1.5
63	35	32	85	27	64	16 ^{+0.070} ₀	25.0 ^{+0.3} _{-0.1}	49	20	40	10	17	11	M10 x 1.25	7	18	40	M18 x 1.5
80	40	37	102	32	78	20 ^{+0.084} ₀	31.5 ^{+0.3} _{-0.1}	61	25	52	14	21	13	M12 x 1.75	10	22	48	M22 x 1.5
100	40	37	116	41	92	25 ^{+0.084} ₀	35.5 ^{+0.3} _{-0.1}	64	30	52	14	21	16	M12 x 1.75	10	26	58	M26 x 1.5

Bore size (mm)	N	P	RR	S	U	H	Z	ZZ
40	27	1/4	10	84	16	51	165	175
50	30	3/8	12	90	19	58	183	195
63	31	3/8	16	98	23	58	196	212
80	37	1/2	20	116	28	71	235	255
100	40	1/2	25	126	36	72	256	281

* Clevis pins, flat washers and cotter pins are included.

- REA
- REB
- REC
- CY
- CX
- MQ
- RHC
- RZQ

- D
- X

Series CA2Y

Center Trunnion Style: CA2YT

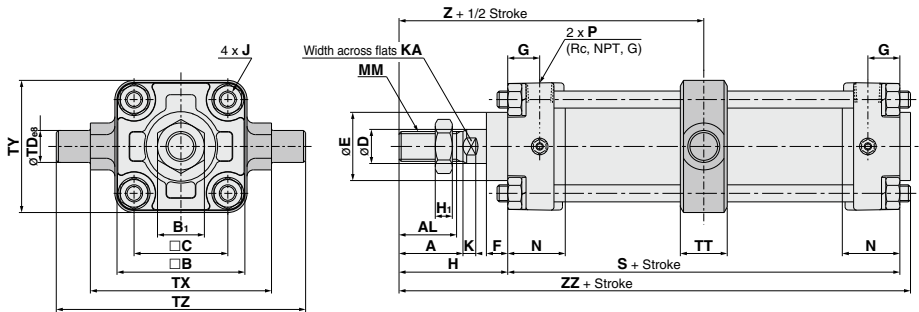

(mm)

Bore size (mm)	A	AL	B	B ₁	C	D	E	F	G	H ₁	J	K	KA	MM	N	P	S	TDe8
40	30	27	60	22	44	16	32	10	15	8	M8 x 1.25	6	14	M14 x 1.5	27	1/4	84	15 ^{-0.032} -0.029
50	35	32	70	27	52	20	40	10	17	11	M8 x 1.25	7	18	M18 x 1.5	30	3/8	90	15 ^{-0.032} -0.029
63	35	32	85	27	64	20	40	10	17	11	M10 x 1.25	7	18	M18 x 1.5	31	3/8	98	18 ^{-0.032} -0.029
80	40	37	102	32	78	25	52	14	21	13	M12 x 1.75	10	22	M22 x 1.5	37	1/2	116	25 ^{-0.040} -0.037
100	40	37	116	41	92	30	52	14	21	16	M12 x 1.75	10	26	M26 x 1.5	40	1/2	126	25 ^{-0.040} -0.037

Bore size (mm)	TT	TX	TY	TZ	H	Z	ZZ
40	22	85	62	117	51	93	140
50	22	95	74	127	58	103	154
63	28	110	90	148	58	107	162
80	34	140	110	192	71	129	194
100	40	162	130	214	72	135	206

* Do not disassemble the trunnion style. It is extremely difficult to align the axial center of the trunnion with the axial center of the cylinder. Thus, if this style of cylinder is disassembled and reassembled, it is likely that the required dimensional accuracy cannot be attained, which may cause malfunction.

Trunnion and Double Clevis Mounting Bracket

• Strength is the same as cylinder brackets.

Bore size	40	50	63	80	100
Trunnion mounting bracket	CA2-S04		CA2-S06	MB-S10	
Double clevis bracket	CA2-B04	CA2-B05	CA2-B06	CA2-B08	CA2-B10

Note) 1. The above brackets cannot be specified in the part number of the cylinder.
 2. They must be ordered separately from the part.
 3. When the trunnion brackets are specified, two pieces should be ordered for each cylinder.

Trunnion bracket

Material: Cast iron

* This assembly drawing is provided as a reference. The trunnion bracket must be ordered separately.

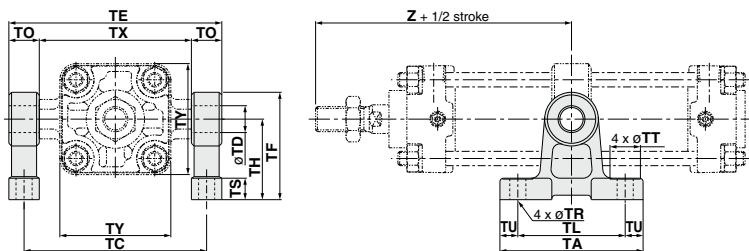

(mm)

Part no.	Bore size (mm)	TA	TL	TU	TC	TX	TE	TO	TR	TT	TS	TH	TF	TY	Z	TD-H10 (Hole)
CA2-S04	40	80	60	10	102	85	119	17	9	17	12	45	60	62	93	15 ^{+0.070} ₀
	50	80	60	10	112	95	129	17	9	17	12	45	60	74	103	15 ^{+0.070} ₀
CA2-S06	63	100	70	15	130	110	150	20	11	22	14	55	73	90	107	18 ^{+0.070} ₀
	80	120	90	15	166	140	192	26	13.5	24	17	75	100	110	129	25 ^{+0.084} ₀
MB-S10	100	120	90	15	188	162	214	26	13.5	24	17	75	100	130	135	25 ^{+0.084} ₀

Double clevis bracket

Material: Cast iron

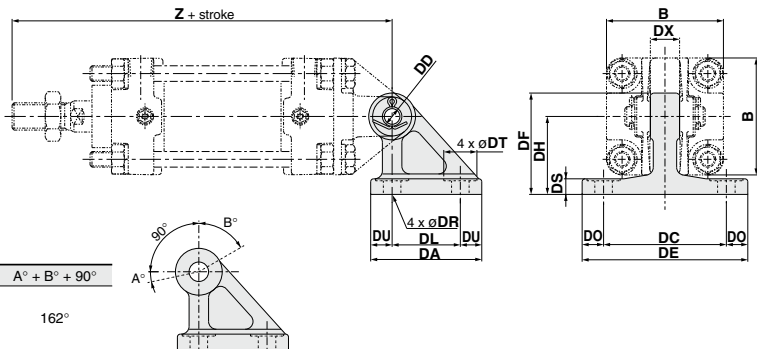

Rotation

Bore size (mm)	A°	B°	A° + B° + 90°
40 to 100	12°	60°	162°

Note) This assembly drawing is provided as a reference. The trunnion bracket must be ordered separately.

(mm)

Part no.	Bore size (mm)	DA	DL	DU	DC	DX	DE	DO	DR	DT	DS	DH	DF	B	Z	DDH10 (Hole)
CA2-B04	40	57	35	11	65	15	85	10	9	17	8	40	52	60	165	10 ^{+0.058} ₀
CA2-B05	50	57	35	11	65	18	85	10	9	17	8	40	52	70	183	12 ^{+0.070} ₀
CA2-B06	63	67	40	13.5	80	25	105	12.5	11	22	10	50	66	85	196	16 ^{+0.070} ₀
CA2-B08	80	93	60	16.5	100	31.5	130	15	13.5	24	12	65	90	102	235	20 ^{+0.084} ₀
CA2-B10	100	93	60	16.5	100	35.5	130	15	13.5	24	12	65	90	116	256	25 ^{+0.084} ₀

- REA
- REB
- REC
- CY
- CX
- MQ
- RHC
- RZQ

- D-□
- X□

Accessory Dimensions

Y Type Double Knuckle Joint

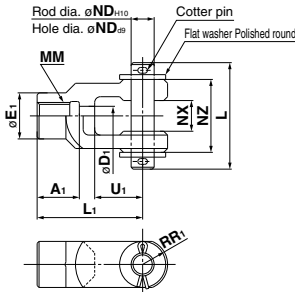

Material: Cast iron (mm)

Part no.	Applicable bore size (mm)	A1	E1	D1	L1	MM	RR1	U1	ND	NX	NZ	L	Cotter pin size	Flat washer size
Y-04D	40	22	24	10	55	M14 x 1.5	13	25	12	16 ^{+0.3} _{-0.1}	38	55.5	ø3 x 18ℓ	Polished round 12
Y-05D	50, 63	27	28	14	60	M18 x 1.5	15	27	12	16 ^{+0.3} _{-0.1}	38	55.5	ø3 x 18ℓ	Polished round 12
Y-08D	80	37	36	18	71	M22 x 1.5	19	28	18	28 ^{+0.3} _{-0.1}	55	76.5	ø4 x 25ℓ	Polished round 18
Y-10D	100	37	40	21	83	M26 x 1.5	21	38	20	30 ^{+0.3} _{-0.1}	61	83	ø4 x 30ℓ	Polished round 20

* Knuckle pin, cotter pin and flat washer are included.

Clevis Pin/Knuckle Pin

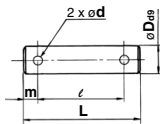

Material: Carbon steel (mm)

Part no.	Applicable bore size (mm)		Dd9	L	ℓ	m	d drill through	Applicable cotter pin	Applicable flat washer
	Clevis	Knuckle							
CDP-2A	40	—	10 ^{-0.040} _{-0.076}	46	38	4	3	ø3 x 18ℓ	Polished round 10
CDP-3A	50	40, 50, 63	12 ^{-0.050} _{-0.093}	55.5	47.5	4	3	ø3 x 18ℓ	Polished round 12
CDP-4A	63	—	16 ^{-0.050} _{-0.093}	71	61	5	4	ø4 x 25ℓ	Polished round 16
CDP-5A	—	80	18 ^{-0.050} _{-0.093}	76.5	66.5	5	4	ø4 x 25ℓ	Polished round 18
CDP-6A	80	100	20 ^{-0.065} _{-0.117}	83	73	5	4	ø4 x 30ℓ	Polished round 20
CDP-7A	100	—	25 ^{-0.065} _{-0.117}	88	78	5	4	ø4 x 36ℓ	Polished round 24

* Cotter pin and flat washer are included.

I Type Single Knuckle Joint

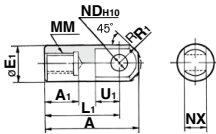

Material: Free cutting sulfur steel (mm)

Part no.	Applicable bore size (mm)	A	A1	E1	L1	MM	R1	U1	ND ^{H10}	NX
I-04A	40	69	22	24	55	M14 x 1.5	15.5	20	12 ^{+0.070} ₀	16 ^{-0.1} _{-0.2}
I-05A	50, 63	74	27	28	60	M18 x 1.5	15.5	20	12 ^{+0.070} ₀	16 ^{-0.1} _{-0.2}
I-08A	80	91	37	36	71	M22 x 1.5	22.5	26	18 ^{+0.070} ₀	28 ^{-0.3} _{-0.4}
I-10A	100	105	37	40	83	M26 x 1.5	24.5	28	20 ^{+0.084} ₀	30 ^{-0.1} _{-0.2}

Rod End Nut (Standard option)

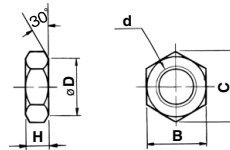

Material: Rolled steel (mm)

Part no.	Applicable bore size (mm)	d	H	B	C	D
NT-04	40	M14 x 1.5	8	22	25.4	21
NT-05	50, 63	M18 x 1.5	11	27	31.2	26
NT-08	80	M22 x 1.5	13	32	37.0	31
NT-10	100	M26 x 1.5	16	41	47.3	39

Series CA2Y

Auto Switch Mounting 1

Auto Switch Proper Mounting Position (Detection at Stroke End) and Its Mounting Height

<Band mount type>

D-B5□/B64/B59W

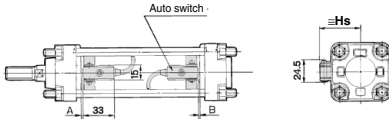

D-A3□

D-G39/K39

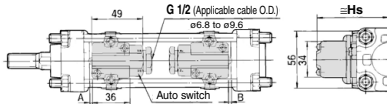

D-G5□/K59

D-G5□W/K59W

D-G59F/G5NT

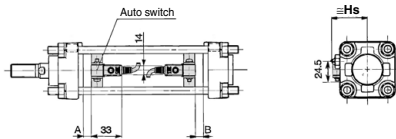

D-A44

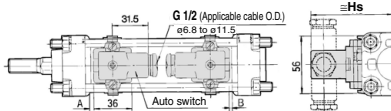

<Tie-rod mount type>

D-A9□/A9□V

D-M9□/M9□V

D-M9□W/M9□WV

D-M9□A/M9□AV

D-Z7□/Z80

D-Y59□/Y69□/Y7P/Y7PV

D-Y7□W/Y7□WV

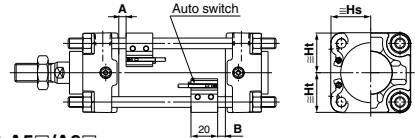

D-A5□/A6□

D-A59W

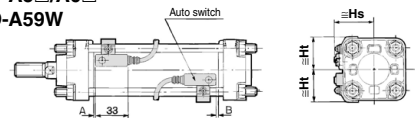

D-A3□C

D-G39C/K39C

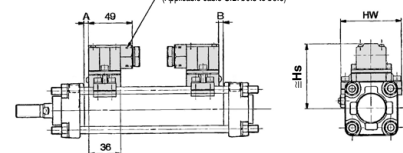

D-F5□/J5□

D-F5NT

D-F5□W/J59W

D-F59F

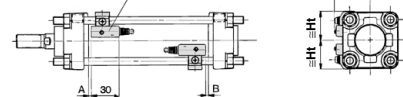

D-A44C

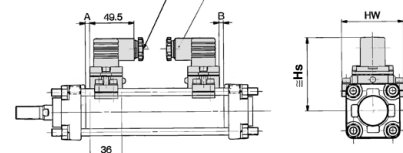

D-P3DW

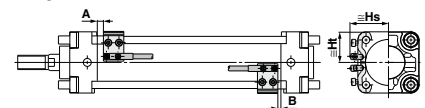

D-P4DW

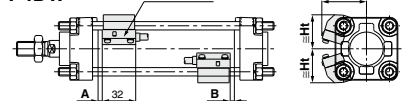

REA

REB

REC

□Y

□X

MQ

RHC

RZQ

D-□

-X□

Series CA2Y

Auto Switch Mounting 2

Auto Switch Proper Mounting Position (Detection at Stroke End) and Its Mounting Height

Auto Switch Proper Mounting Position

(mm)

Auto switch model	Note 2) D-A9□ D-A9□V		D-M9□ D-M9□V D-M9□W D-M9□WV D-M9□A D-M9□AV		D-B59W D-Z7□ D-Z80 D-Y59□ D-Y69□ D-Y7P D-Y7PV D-Y7□W D-Y7□WV		D-P3DW		D-P4DW		D-A5□ D-A6□ D-A3□C D-A44 D-A44C D-G39 D-G39C D-K39 D-K39C		D-B5□ D-B64		D-F5□ D-J5□ D-F59F D-F5□W D-J59W		D-G5□ D-K59 D-G5NT D-G5□W D-K59W D-G59F		D-A59W		D-F5NT	
	A	B	A	B	A	B	A	B	A	B	A	B	A	B	A	B	A	B	A	B	A	B
40	6	4	10	8	3.5	1.5	6	3	3	1	0	0	0.5	0	6.5	4.5	2	0	4	2	11.5	9.5
50	—	—	10	8	3.5	1.5	5.5	3.5	3	1	0	0	0.5	0	6.5	4.5	2	0	4	2	11.5	9.5
63	8.5	7.5	12.5	11.5	6	5	3	1.5	5.5	4	2.5	1.5	3	2	9	8	4.5	3.5	6.5	5.5	14	13
80	12	10	16	14	9.5	7.5	6	4.5	9	7	6	4	6.5	4.5	4.5	12.5	8	6	10	8	17.5	15.5
100	13.5	12.5	17.5	16.5	11	10	8	6.5	10.5	9	7.5	6.5	8	7	14	13	9.5	8.5	11.5	10.5	19	18

Note 1) Adjust the auto switch after confirming the operating conditions in the actual setting.

Auto Switch Mounting Height

(mm)

Auto switch model	Note 2) D-A9□ D-M9□ D-M9□W D-M9□A		Note 2) D-A9□V		D-M9□V D-M9□WV D-M9□AV		D-Z7□ D-Z80 D-Y59□ D-Y7P D-Y7□W		D-Y69□ D-Y7PV D-Y7□WV		D-P3DW		D-P4DW		D-B5□ D-B64 D-B59W D-G5□ D-K59 D-G5NT D-G5□W D-K59W D-G59F		D-A3□ D-G39 D-K39		D-A44		D-A5□ D-A6□ D-A59W		D-F5□ D-J59 D-F5□W D-J59W D-F59F D-F5NT		D-A3□C D-G39C D-K39C		D-A44C	
	Hs	Ht	Hs	Ht	Hs	Ht	Hs	Ht	Hs	Ht	Hs	Ht	Hs	Ht	Hs	Ht	Hs	Ht	Hs	Ht	Hs	Ht	Hs	Hw	Hs	Hw		
40	30	30	31	30	34	30	30	30	30	38	30	42.5	33	37	71.5	81.5	38.5	31.5	38	31.5	73	69	81	69				
50	34	34	—	—	38	34	34	34	34	42	34	46.5	37.5	42	76.5	86.5	42	35.5	42	35.5	78.5	77	86.5	77				
63	41	41	41.5	41	44	41	41	41	41	49	41	52	43	49	83.5	93.5	46.5	43	47	43	85.5	91	83.5	91				
80	49.5	49	50	49	52.5	49	49.5	49	49.5	56	49	58.5	51.5	57.5	92	102	53.5	51	53.5	51	94	107	102	107				
100	56.5	56	58.5	56	61	56	56.5	55.5	57.5	65	56	66	58.5	68	102.5	112.5	61.5	57.5	61	57.5	104	121	112	121				

Note 2) D-A9□/A9□V types cannot be mounted on ø50.

Minimum Auto Switch Mounting Stroke

Auto switch model	Number of auto switch	Brackets other than center trunnion	Center trunnion						
			ø40	ø50	ø63	ø80	ø100		
D-A9□	2 (Different surfaces and same surface) With 1	15	75	—	80	85	90		
	n	$15 + 40 \frac{(n-2)}{2}$ (n = 2, 4, 6, 8, ...) Note 1)	$75 + 40 \frac{(n-4)}{2}$ (n = 4, 8, 12, 16, ...) Note 2)		$80 + 40 \frac{(n-4)}{2}$ (n = 4, 8, 12, 16, ...) Note 2)	$85 + 40 \frac{(n-4)}{2}$ (n = 4, 8, 12, 16, ...) Note 2)	$90 + 40 \frac{(n-4)}{2}$ (n = 4, 8, 12, 16, ...) Note 2)		
D-A9□V	2 (Different surfaces and same surface) With 1	10	50	—	55	60	65		
	n	$10 + 30 \frac{(n-2)}{2}$ (n = 2, 4, 6, 8, ...) Note 1)	$50 + 30 \frac{(n-4)}{2}$ (n = 4, 8, 12, 16, ...) Note 2)		$55 + 30 \frac{(n-4)}{2}$ (n = 4, 8, 12, 16, ...) Note 2)	$60 + 30 \frac{(n-4)}{2}$ (n = 4, 8, 12, 16, ...) Note 2)	$65 + 30 \frac{(n-4)}{2}$ (n = 4, 8, 12, 16, ...) Note 2)		
D-M9□ D-M9□W D-M9□A	2 (Different surfaces and same surface) With 1	15	80	—	85	90	95		
	n	$15 + 40 \frac{(n-2)}{2}$ (n = 2, 4, 6, 8, ...) Note 1)	$80 + 40 \frac{(n-4)}{2}$ (n = 4, 8, 12, 16, ...) Note 2)		$85 + 40 \frac{(n-4)}{2}$ (n = 4, 8, 12, 16, ...) Note 2)	$90 + 40 \frac{(n-4)}{2}$ (n = 4, 8, 12, 16, ...) Note 2)	$95 + 40 \frac{(n-4)}{2}$ (n = 4, 8, 12, 16, ...) Note 2)		
D-M9□V D-M9□WV D-M9□AV	2 (Different surfaces and same surface) With 1	10	55	—	60	65	70		
	n	$10 + 30 \frac{(n-2)}{2}$ (n = 2, 4, 6, 8, ...) Note 1)	$55 + 30 \frac{(n-4)}{2}$ (n = 4, 8, 12, 16, ...) Note 2)		$60 + 30 \frac{(n-4)}{2}$ (n = 4, 8, 12, 16, ...) Note 2)	$65 + 30 \frac{(n-4)}{2}$ (n = 4, 8, 12, 16, ...) Note 2)	$70 + 30 \frac{(n-4)}{2}$ (n = 4, 8, 12, 16, ...) Note 2)		
D-A5□/A6 D-F5□/J5 D-F5□W/J59W D-F59F	2 (Different surfaces and same surface) With 1	15	90	—	100	110	120		
	n (Same surface)	$15 + 55 \frac{(n-2)}{2}$ (n = 2, 4, 6, 8, ...) Note 1)	$90 + 55 \frac{(n-4)}{2}$ (n = 4, 8, 12, 16, ...) Note 2)		$100 + 55 \frac{(n-4)}{2}$ (n = 4, 8, 12, 16, ...) Note 2)	$110 + 55 \frac{(n-4)}{2}$ (n = 4, 8, 12, 16, ...) Note 2)	$120 + 55 \frac{(n-4)}{2}$ (n = 4, 8, 12, 16, ...) Note 2)		
D-A59W	2 (Different surfaces and same surface)	20	90	—	100	110	120		
	n (Same surface)	$20 + 55 \frac{(n-2)}{2}$ (n = 2, 4, 6, 8, ...) Note 1)	$90 + 55 \frac{(n-4)}{2}$ (n = 4, 8, 12, 16, ...) Note 2)		$100 + 55 \frac{(n-4)}{2}$ (n = 4, 8, 12, 16, ...) Note 2)	$110 + 55 \frac{(n-4)}{2}$ (n = 4, 8, 12, 16, ...) Note 2)	$120 + 55 \frac{(n-4)}{2}$ (n = 4, 8, 12, 16, ...) Note 2)		
	1	15	90		100	110	120		
D-F5NT	2 (Different surfaces and same surface) With 1	25	110	—	120	130	140		
	n (Same surface)	$25 + 55 \frac{(n-2)}{2}$ (n = 2, 4, 6, 8, ...) Note 1)	$110 + 55 \frac{(n-4)}{2}$ (n = 4, 8, 12, 16, ...) Note 2)		$120 + 55 \frac{(n-4)}{2}$ (n = 4, 8, 12, 16, ...) Note 2)	$130 + 55 \frac{(n-4)}{2}$ (n = 4, 8, 12, 16, ...) Note 2)	$140 + 55 \frac{(n-4)}{2}$ (n = 4, 8, 12, 16, ...) Note 2)		
D-B5□/B64 D-G5□/K59 D-G5□W D-K59W D-G59F D-G5NT	With 2 Different surfaces	15	90	100	110				
	2 Same surface	75							
	With n	Different surfaces				$15 + 50 \frac{(n-2)}{2}$ (n = 2, 4, 6, 8, ...) Note 1)	$90 + 50 \frac{(n-4)}{2}$ (n = 4, 8, 12, 16, ...) Note 2)	$100 + 50 \frac{(n-4)}{2}$ (n = 4, 8, 12, 16, ...) Note 2)	$110 + 50 \frac{(n-4)}{2}$ (n = 4, 8, 12, 16, ...) Note 2)
		Same surface				$75 + 50(n-2)$ (n = 2, 3, 4, ...)	$90 + 50(n-2)$ (n = 2, 4, 6, 8, ...) Note 1)	$100 + 50(n-2)$ (n = 2, 4, 6, 8, ...) Note 1)	$110 + 50(n-2)$ (n = 2, 4, 6, 8, ...) Note 1)
		1				10	90	100	110
D-B59W	With 2 Different surfaces	20	90	100	110				
	2 Same surface	75							
	With n	Different surfaces				$20 + 50 \frac{(n-2)}{2}$ (n = 2, 4, 6, 8, ...) Note 1)	$90 + 50 \frac{(n-4)}{2}$ (n = 4, 8, 12, 16, ...) Note 2)	$100 + 50 \frac{(n-4)}{2}$ (n = 4, 8, 12, 16, ...) Note 2)	$110 + 50 \frac{(n-4)}{2}$ (n = 4, 8, 12, 16, ...) Note 2)
		Same surface				$75 + 50(n-2)$ (n = 2, 3, 4, ...)	$90 + 50(n-2)$ (n = 2, 4, 6, 8, ...) Note 1)	$100 + 50(n-2)$ (n = 2, 4, 6, 8, ...) Note 1)	$110 + 50(n-2)$ (n = 2, 4, 6, 8, ...) Note 1)
		1				15	90	100	110
D-A3□ D-G39 D-K39	With 2 Different surfaces	35	75	80	90				
	2 Same surface	100							
	With n	Different surfaces				$35 + 30(n-2)$ (n = 2, 3, 4, ...)	$75 + 30(n-2)$ (n = 2, 4, 6, 8, ...) Note 1)	$80 + 30(n-2)$ (n = 2, 4, 6, 8, ...) Note 1)	$90 + 30(n-2)$ (n = 2, 4, 6, 8, ...) Note 1)
		Same surface				$100 + 100(n-2)$ (n = 2, 3, 4, ...)	$100 + 100(n-2)$ (n = 2, 4, 6, 8, ...) Note 1)	$100 + 100(n-2)$ (n = 2, 4, 6, 8, ...) Note 1)	$100 + 100(n-2)$ (n = 2, 4, 6, 8, ...) Note 1)
		1				10	75	80	90
D-A44	With 2 Different surfaces	35	75	80	90				
	2 Same surface	55							
	With n	Different surfaces				$35 + 30(n-2)$ (n = 2, 3, 4, ...)	$75 + 30(n-2)$ (n = 2, 4, 6, 8, ...) Note 1)	$80 + 30(n-2)$ (n = 2, 4, 6, 8, ...) Note 1)	$90 + 30(n-2)$ (n = 2, 4, 6, 8, ...) Note 1)
		Same surface				$55 + 50(n-2)$ (n = 2, 3, 4, ...)	$75 + 50(n-2)$ (n = 2, 4, 6, 8, ...) Note 1)	$80 + 50(n-2)$ (n = 2, 4, 6, 8, ...) Note 1)	$90 + 50(n-2)$ (n = 2, 4, 6, 8, ...) Note 1)
		1				10	75	80	90

Note 1) When "n" is an odd number, an even number that is one larger than this odd number is used for the calculation.
 Note 2) When "n" is an odd number, a multiple of 4 that is larger than this odd number is used for the calculation.

- REA**
- REB**
- REC**
- COY**
- COX**
- MQ**
- RHC**
- RZQ**

- D-□**
- X□**

Auto Switch Mounting 3

Minimum Auto Switch Mounting Stroke

Auto switch model	Number of auto switch	Brackets other than center trunnion	Center trunnion (mm)					
			ø40	ø50	ø63	ø80	ø100	
D-A3□C D-G39C D-K39C	With 2	Different surfaces	20		75	80	90	100
		Same surface	100		100	100	100	
	With n	Different surfaces	20 + 35 (n - 2) (n = 2, 3, 4, ...)	75 + 35 (n - 2) (n = 2, 4, 6, 8, ...) ^{Note 1)}		80 + 35 (n - 2) (n = 2, 4, 6, 8, ...) ^{Note 1)}	90 + 35 (n - 2) (n = 2, 4, 6, 8, ...) ^{Note 1)}	
		Same surface	100 + 100 (n - 2) (n = 2, 2, 3, 4, 5...)	100 + 100 (n - 2) (n = 2, 4, 6, 8, ...) ^{Note 1)}		80		
	1	10	75		80	90		
D-A44C	With 2	Different surfaces	20		75	80	90	100
		Same surface	55		75	80	90	100
	With n	Different surfaces	20 + 35 (n - 2) (n = 2, 3, 4, ...)	75 + 35 (n - 2) (n = 2, 4, 6, 8, ...) ^{Note 1)}		80 + 35 (n - 2) (n = 2, 4, 6, 8, ...) ^{Note 1)}	90 + 35 (n - 2) (n = 2, 4, 6, 8, ...) ^{Note 1)}	
		Same surface	55 + 50 (n - 2) (n = 2, 3, 4, ...)	75 + 50 (n - 2) (n = 2, 4, 6, 8, ...) ^{Note 1)}		80 + 50 (n - 2) (n = 2, 4, 6, 8, ...) ^{Note 1)}	90 + 50 (n - 2) (n = 2, 4, 6, 8, ...) ^{Note 1)}	
	1	10	75		80	90		
D-Z7□/Z80 D-Y59□/Y7P D-Y7□W	2 (Different surfaces and same surface) With 1	15	80	85	90	95	105	
	n	15 + 40 $\frac{(n-2)}{2}$ (n = 2, 4, 6, 8...) ^{Note 1)}	80 + 40 $\frac{(n-4)}{2}$ (n = 4, 8, 12, 16...) ^{Note 2)}	85 + 40 $\frac{(n-4)}{2}$ (n = 4, 8, 12, 16...) ^{Note 2)}	90 + 40 $\frac{(n-4)}{2}$ (n = 4, 8, 12, 16...) ^{Note 2)}	95 + 40 $\frac{(n-4)}{2}$ (n = 4, 8, 12, 16...) ^{Note 2)}	105 + 40 $\frac{(n-4)}{2}$ (n = 4, 8, 12, 16...) ^{Note 2)}	
D-Y69□/Y7PV D-Y7□WV	2 (Different surfaces and same surface) With 1	10	65		75	80	90	
	n	10 + 30 $\frac{(n-2)}{2}$ (n = 2, 4, 6, 8...) ^{Note 1)}	65 + 30 $\frac{(n-4)}{2}$ (n = 4, 8, 12, 16...) ^{Note 2)}		75 + 30 $\frac{(n-4)}{2}$ (n = 4, 8, 12, 16...) ^{Note 2)}	80 + 30 $\frac{(n-4)}{2}$ (n = 4, 8, 12, 16...) ^{Note 2)}	90 + 30 $\frac{(n-4)}{2}$ (n = 4, 8, 12, 16...) ^{Note 2)}	
D-P3DW	2 (Different surfaces and same surface) With 1	15	85					
	n	15 + 50 $\frac{(n-2)}{2}$ (n = 2, 4, 6, 8...) ^{Note 1)}	85 + 50 $\frac{(n-4)}{2}$ (n = 4, 8, 12, 16...) ^{Note 2)}					
D-P4DW	2 (Different surfaces and same surface) With 1	15	120	130	140			
	n	15 + 65 $\frac{(n-2)}{2}$ (n = 2, 4, 6, 8...) ^{Note 1)}	120 + 65 $\frac{(n-4)}{2}$ (n = 4, 8, 12, 16...) ^{Note 2)}	130 + 65 $\frac{(n-4)}{2}$ (n = 4, 8, 12, 16...) ^{Note 2)}	140 + 65 $\frac{(n-4)}{2}$ (n = 4, 8, 12, 16...) ^{Note 2)}			

Note 1) When "n" is an odd number, an even number that is one larger than this odd number is used for the calculation.
 Note 2) When "n" is an odd number, a multiple of 4 that is larger than this odd number is used for the calculation.

Operating Range

Auto switch model	Bore size (mm)				
	40	50	63	80	100
D-A9□/A9□V	7	—	9	9	9
D-M9□/M9□V D-M9□W/M9□WV D-M9□A/M9□AV	4.5	5	5.5	5	6
D-Z7□/Z80	8.5	7.5	9.5	9.5	10.5
D-A3□/A44 D-A3□C/A44C	9	10	11	11	11
D-A5□/A6□					
D-B5□/B64					
D-A59W	13	13	14	14	15
D-B59W	14	14	17	16	18
D-Y59□/Y69□ D-Y7P/Y7□V D-Y7□W/Y7□WV	8	7	5.5	6.5	6.5

Auto switch model	Bore size (mm)				
	40	50	63	80	100
D-F5□/J5□/F5□W D-J59W D-F5NT/F59F	4	4	4.5	4.5	4.5
D-G5□/K59/G5□W D-K59W D-G5NTL/G59F	5	6	6.5	6.5	7
D-G39/K39 D-G39C/K39C	9	9	10	10	11
D-P3DW	4.5	5	6	5.5	6
D-P4DW	4	4	4.5	4	4.5

* Since this is a guideline including hysteresis, not meant to be guaranteed. (assuming approximately ±30% dispersion.)
 There may be the case it will vary substantially depending on an ambient environment.
 Note) D-A9□/A9□V types cannot be mounted on ø50.

Auto Switch Mounting Bracket/Part No.

<Tie-rod mounting>

Auto switch model	Bore size (mm)				
	40	50	63	80	100
D-A9□/A9□V D-M9□/M9□V D-M9□W/M9□WV D-M9□A/M9□AV	BA7-040	BA7-040	BA7-063	BA7-080	BA7-080
D-A5□/A6□ D-A59W D-F5□/J5□ D-F5□W/J59W D-F59F/F5NT	BT-04	BT-04	BT-06	BT-08	BT-08
D-A3□C/A44C D-G39C/K39C	BA3-040	BA3-050	BA3-063	BA3-080	BA3-100
D-Z7□/Z80 D-Y59□/Y69□ D-Y7P/Y7PV D-Y7□W/Y7□WV	BA4-040	BA4-040	BA4-063	BA4-080	BA4-080
D-P3DW	BMB9-050S	BMB9-050S	BA9T-063S	BA9T-080S	BA9T-080S
D-P4DW	BAP2-040	BAP2-040	BAP2-063	BAP2-080	BAP2-080

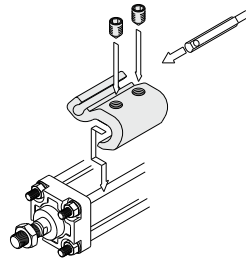

• Mounting example of D-A9□(V)/M9□(V)/M9□W(V)/M9□A(V)

<Band mounting>

Auto switch model	Bore size (mm)				
	40	50	63	80	100
D-A3□/A44 D-G39/K39	BD1-04M	BD1-05M	BD1-06M	BD1-08M	BD1-10M
D-B5□/B64 D-B59W D-G5□/K59 D-G5□W/K59W D-G59F D-G5NT	BA-04	BA-05	BA-06	BA-08	BA-10

* Auto switch mounting brackets are included in D-A3□C/A44C/G39C/K39C types. Indicate as follows depending on the cylinder size when ordering.
(Example) ø40: D-A3□C-4, ø50: D-A3□C-5, ø63: D-A3□C-6, ø80: D-A3□C-8, ø100: D-A3□C-10

Other than the applicable auto switches listed in "How to Order", the following auto switches can be mounted.
For detailed specifications, refer to pages 1893 to 2007.

Auto switch type	Model	Electrical entry (Direction)	Features	Applicable bore size
Reed	D-A93V, A96V	Grommet (Perpendicular)	—	ø40, ø63, ø80, ø100
	D-A90V		Without indicator light	
	D-A53, A56, B53, Z73, Z76	Grommet (In-line)	—	ø40 to ø100
	D-A67, Z80		Without indicator light	
Solid state	D-M9NV, M9PV, M9BV	Grommet (Perpendicular)	—	ø40 to ø100
	D-Y69A, Y69B, Y7PV		Diagnostic indication	
	D-M9NWV, M9PWW, M9BWW		(2-color indication)	
	D-Y7NWV, Y7PWW, Y7BWW		Water resistant (2-color indication)	
	D-M9NAV, M9PAV, M9BAV	Grommet (In-line)	—	ø40 to ø100
	D-Y59A, Y59B, Y7P		Diagnostic indication	
	D-F59, F5P, J59		(2-color indication)	
	D-Y7NW, Y7PW, Y7BW		With timer	
	D-F59W, F5PW, J59W		Magnetic field resistant (2-color indication)	
	D-F5NTL, G5NT			
	D-P5DW			

* With pre-wired connector is available for solid state auto switches. For details, refer to pages 1960 and 1961.

* Normally closed (NC = b contact) solid state auto switches (D-F9G/F9H/Y7G/Y7H types) are also available. Refer to pages 1911 and 1913 for details.

* Wide range detection type, solid state auto switches (D-G5NB type) are also available. Refer to page 1953 for details.

REA

REB

REC

C□Y

C□X

MQ

RHC

RZQ

D-□

-X□

Smooth Cylinder

Series CS2Y

∅125, ∅140, ∅160

How to Order

CS2Y L 160 - **300** - **M9BW**

With auto switch **CDS2Y L 160** - **300** - **M9BW**

With auto switch
(Built-in magnet)

Smooth Cylinder

Mounting

B	Basic
L	Foot
F	Rod flange
G	Head flange
C	Single clevis
D	Double clevis
T	Center trunnion

Bore size

125	125 mm
140	140 mm
160	160 mm

Port thread type

Nil	Rc
TN	NPT
TF	G

Cylinder stroke (mm)
Refer to page 1229 for the "Maximum Stroke" table.

Number of auto switches

Nil	2 pcs.
S	1 pc.
3	3 pcs.
n	"n" pcs.

Made to Order
For details, refer to page 1229.

Auto switch

Nil	Without auto switch
-----	---------------------

* Refer to the table below for the applicable auto switch model.

Suffix for cylinder

Row boot	J	Nylon tarpaulin
	K	Heat resistant tarpaulin
	A	With double-side cushion
With/without cushion	R	With rod cushion
	H	With head cushion
	Nil	Without cushion

* When more than one symbol is specified, indicate them in alphabetical order.

Built-in Magnet Cylinder Model

If a built-in magnet cylinder without auto switch is required, there is no need to enter the symbol for auto switch.
(Example) CDS2YL125-200

Applicable Auto Switches / For detailed auto switch specifications, refer to pages 1893 to 2007.

Type	Special function	Electrical entry	Micro light	Wiring (Output)	Load voltage		Auto switch model		Lead wire length (m)					Pre-wired connector	Applicable load
					DC	AC	Tie-rod mounting	Band mounting	0.5 (Nil)	1 (M)	3 (L)	5 (Z)			
Solid state auto switch	—	Grommet	No	3-wire (NPN)	24 V	5 V, 12 V	—	M9N	●	●	○	○	—	IC circuit	Relay, PLC
				3-wire (PNP)				M9P	○	●	●	○			
		2-wire	—	100 V, 200 V	M9B	●	●	○	○	—					
		—			J51	●	●	○	○						
	Diagnostic indication (2-color indication)	Terminal conduit	Yes	3-wire (NPN)	24 V	5 V, 12 V	—	G39	—	—	—	—	—	IC circuit	
				2-wire				K39	—	—	—	—			
	Water resistant (2-color indication)	Grommet	No	3-wire (NPN)	24 V	5 V, 12 V	—	M9NW	●	●	○	○	—	IC circuit	
				3-wire (PNP)				M9PW	○	●	●	○			
	Diagnostic indication (2-color indication)	Terminal conduit	Yes	2-wire	—	100 V, 200 V	—	M9BW	●	●	○	○	—	—	
				3-wire (NPN)				M9NA**	○	○	●	○			
Diagnostic indication (2-color indication)	Grommet	No	3-wire (PNP)	24 V	5 V, 12 V	—	M9PA**	○	○	●	○	—	IC circuit		
			2-wire				M9BA**	○	○	○	○				
Reed auto switch	—	Grommet	Yes	3-wire (NPN equivalent)	24 V	5 V	—	F59F	●	—	●	○	—	IC circuit	
				—				A96	●	—	●	—			
		Diagnostic indication (2-color indication)	Terminal conduit	No	2-wire	24 V	12 V	100 V	A93	●	—	●	●	—	IC circuit
									5 V, 12 V	A90	●	—	●		
	Diagnostic indication (2-color indication)	DIN terminal	Yes	2-wire	24 V	12 V	100 V or less	A54	●	—	●	●	—	—	
								100 V, 200 V	A64	●	—	●			—
	Diagnostic indication (2-color indication)	Grommet	No	2-wire	24 V	12 V	200 V or less	—	A33	—	—	—	—	PLC	
								100 V, 200 V	A34	—	—	—			—
	Diagnostic indication (2-color indication)	Grommet	Yes	2-wire	24 V	12 V	100 V, 200 V	—	A44	—	—	—	—	Relay, PLC	
								—	A59W	—	●	—			●

** Water resistant type auto switches can be mounted on the above models, but in such case SMC cannot guarantee water resistance. Consult with SMC regarding water resistant types with the above model numbers.

* Lead wire length symbols: 0.5 m Nil (Example) M9NW
1 m M (Example) M9NWM
3 m L (Example) M9NWL
5 m Z (Example) M9NZ

* Solid state auto switches marked with "○" are produced upon receipt of order.

* Since there are applicable auto switches other than listed, refer to page 1240 for details.
* For details about auto switches with pre-wired connector, refer to pages 1960 and 1961.
* D-A9□, M9□, M9□W, M9□A are shipped together (but not assembled). (Only auto switch mounting bracket is assembled at the time of shipment.)

Designed with a low sliding resistance of the piston, this air cylinder is ideal for applications such as contact pressure control, which requires smooth movements at low pressure.

Low sliding resistance

Min. operating pressure — 0.005 MPa

Auto switch mounting is possible



Symbol

Double acting/Without cushion



Made to Order specifications (For details, refer to pages 2009 to 2152.)

Symbol	Specifications
-XA□	Change of rod end shape
-XC3	Special port position
-XC14	Change of trunnion bracket mounting position
-XC15	Change of tie-rod length
-XC26	Double clevis pin/Double knuckle pin with split pin and flat washer
-XC27	Double clevis pin and double knuckle pin made of stainless steel
-XC30	Rod side trunnion mounted on the front of the rod cover
-XC68	Made of stainless steel (With hard chrome plated piston rod)
-XC86	With rod end bracket

For the specifications of cylinders with auto switch, please refer to pages 1238 to 1240.

- Minimum stroke for auto switch mounting
- Auto switch proper mounting position (detection at stroke end) and its mounting height
- Operating range
- Auto switch mounting bracket part no.

Application Example

Low friction cylinder is used in combination with precision regulator (Series IR).

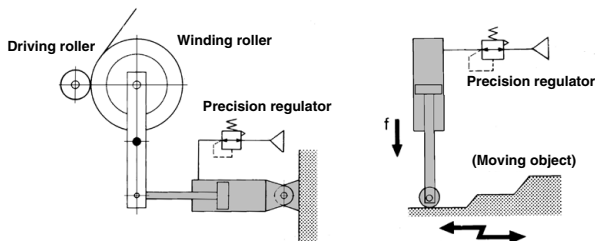

Specifications

Bore size (mm)	125	140	160
Action	Double acting, Single rod		
Direction of low friction	Both directions		
Fluid	Air		
Proof pressure	1.05 MPa		
Maximum operating pressure	0.7 MPa		
Minimum operating pressure	0.005 MPa*		
Ambient and fluid temperature	Without auto switch	0 to 70°C (No freezing)	
	With auto switch	0 to 60°C (No freezing)	
Allowable leakage	Less than 0.5 L/min (ANR)		
Cushion	Without cushion** (manufacturable with cushion)		
Lubrication	Not required (Non-lube)		
Mounting	Basic, Foot, Rod flange, Head flange, Single clevis, Double clevis, Center trunnion		

- * If a cushion is used, this value will not include the operating pressure within the cushion stroke.
- ** If an air cushion is not used, set the energy at the stroke end to 0.36J or less.

Maximum Stroke

Tube material	Aluminum alloy	Carbon steel tube	
Mounting bracket Bore size (mm)	Basic, Head flange, Single clevis, Double clevis, Center trunnion, Rod flange	Basic, Head flange, Single clevis, Double clevis, Center trunnion	Foot, Rod flange
	125	1000 or less	1600 or less
	140	1000 or less	1600 or less
	160	1200 or less	1600 or less

Accessory

Mounting		Basic	Foot	Rod flange	Head flange	Single clevis	Double clevis	Center trunnion
Standard equipment	Clevis pin	—	—	—	—	—	●	—
	Rod end nut	●	●	●	●	●	●	●
Option	Single knuckle joint	●	●	●	●	●	●	●
	Double knuckle joint (Knuckle pin, Split pin)	●	●	●	●	●	●	●
	Rod boot	●	●	●	●	●	●	●

REA

REB

REC

CEY

CEX

MQ

RHC

RZQ

D-□

-X□

Series CS2Y

Mounting Bracket Part No.

Bore size (mm)	125	140	160
Foot*	CS2-L12	CS2-L14	CS2-L16
Flange	CS2-F12	CS2-F14	CS2-F16
Single clevis	CS2-C12	CS2-C14	CS2-C16
Double clevis**	CS2-D12	CS2-D14	CS2-D16

* Order two foot brackets per cylinder.

** When ordering the double clevis style, the clevis pin and 2 split pins are included as accessories.

Rod Boot Material

Symbol	Material	Max. ambient temperature
J	Nylon tarpaulin	70°C
K	Heat resistant tarpaulin	110°C*

* Maximum ambient temperature for the rod boot itself.

Weight

Bore size (mm)		125	140	160
Basic weight	Basic	5.46	6.50	9.07
	Foot	7.49	9.50	12.45
	Rod flange	8.51	12.03	15.80
	Head flange	8.51	12.03	15.80
	Single clevis	8.53	10.79	14.56
	Double clevis	8.99	11.54	15.41
	Trunnion	9.59	12.23	15.47
Additional weight with magnet (With built-in magnet and auto switch)		0.07	0.07	0.08
Additional weight per each 100 mm of stroke		1.55	1.67	2.23
Accessory bracket	Single knuckle	0.91	1.16	1.56
	Double knuckle (With Knuckle pin, Split pin)	1.37	1.81	2.48
	Rod end nut	0.16	0.16	0.23

Calculation: (Example) **CS2Y160-500**

- Basic weight 12.45 (kg)
- Additional weight 2.23 (kg/100 mm)
- Cylinder stroke 500 (mm)
- $12.45 + 2.23 \times 500/100 = 23.60$ (kg)

Sliding Resistance

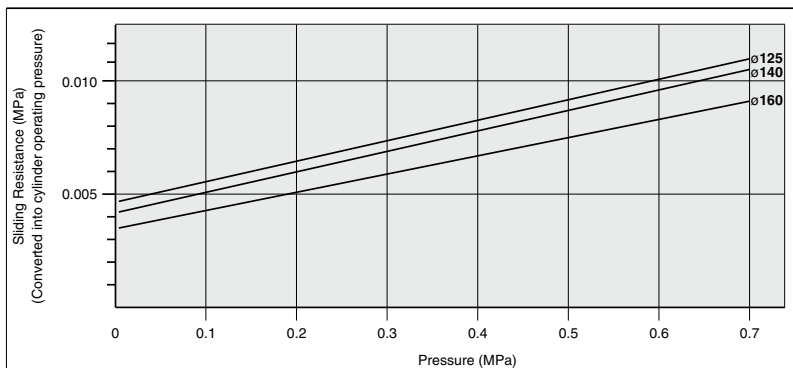

Relation between Cylinder Size and Maximum Stroke

The below table shows the applicable maximum stroke (in cm units), found by calculation assuming the case where the force generated by the cylinder itself acts as buckling force on the piston rod, or piston rod and cylinder tube.

Therefore, it is possible to find the applicable maximum stroke for each cylinder size using the relationship between the size of the operating pressure and the cylinder support type, regardless of the load ratio.

[Reference] If it is stopped with the external stopper on the cylinder extension side, even with a light load, the maximum generated force of the cylinder will act on the cylinder itself.

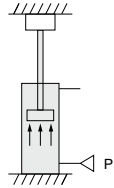

Mounting			Operating pressure (MPa)	Applicable max. stroke according to buckling strength (cm)		
Support bracket nominal symbol and schematic diagram		Nominal symbol		125	140	160
Foot: L	Rod flange: F	Head flange: G	0.3	103	92	113
			0.5	79	70	86
			0.7	66	58	72
			0.3	45	38	47
			0.5	33	27	34
			0.7	26	22	27
			0.3	96	83	106
Clevis: C, D		Center trunnion: T	0.5	71	61	76
			0.7	59	50	62
			0.3	135	119	147
			0.5	101	89	111
			0.7	84	74	91
			0.3	301	267	330
			0.5	231	207	253
Foot: L	Rod flange: F	Head flange: G	0.7	193	172	212
			0.3	144	126	156
			0.5	109	94	118
			0.7	90	78	97
Foot: L	Rod flange: F	Head flange: G	0.3	433	386	476
			0.5	334	297	367
			0.7	281	250	309
			0.3	210	185	229
			0.5	160	141	175
			0.7	134	117	129

REA

REB

REC

COY

COX

MQ

RHC

RZQ

D-□

-X□

Construction

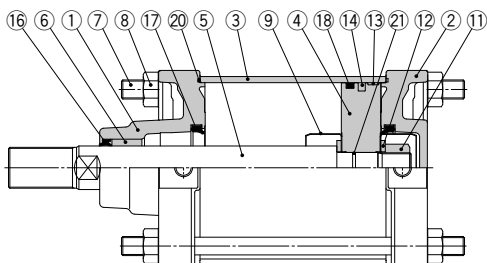
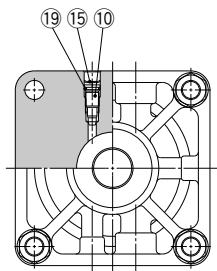

Component Parts

No.	Description	Material	Note
1	Rod cover	Aluminum die-cast	Chromated
2	Head cover	Aluminum die-cast	Chromated
3	Cylinder tube	Aluminum alloy	Hard anodized
4	Piston	Aluminum alloy	Chromated
5	Piston rod	Carbon steel	Hard chrome plated
6	Bushing	Oil-impregnated sintered alloy	
7	Tie-rod	Carbon steel	Zinc chromated
8	Tie-rod nut	Rolled steel	Nickel plated
9	Cushion ring	Stainless steel	
10	Cushion valve	Rolled steel	Nickel plated
11	Piston nut	Carbon steel	Nickel plated
12	Flat washer	Carbon steel	Nickel plated
13	Wear ring	Resin	
14	Magnet*	—	
15	Retaining ring	Spring steel	Phosphate treatment
16	Rod seal	NBR	
17	Cushion seal**	Urethane	
18	Piston seal	NBR	
19	Valve seal	NBR	
20	Tube gasket	NBR	
21	Piston gasket	NBR	

* For types with built-in magnet or with auto switch.

** Used with cushion only.

Replacement Parts: Seal kit.

Bore size (mm)	Kit no.	Content
125	CS2Y125A-PS	Without cushion
140	CS2Y140A-PS	Consists of Component Part Numbers 16, 18, and 20
160	CS2Y160A-PS	
125	CS2Y125AA-PS	With single-side cushion
140	CS2Y140AA-PS	Consists of Component Part Numbers 16, 17 (two), 18, and 20
160	CS2Y160AA-PS	
125	CS2Y125AR-PS	With single-side cushion
140	CS2Y140AR-PS	Consists of Component Part Numbers 16, 17 (one), 18 and 20.
160	CS2Y160AR-PS	

* Seal kit does not include a grease pack.

Order with the following part number when only the grease pack is needed.

Grease pack part number: GR-L-005 (5 g), GR-S-010 (10 g), GR-L-150 (150g)

Dimensions

Basic: CS2YB

With rod boot

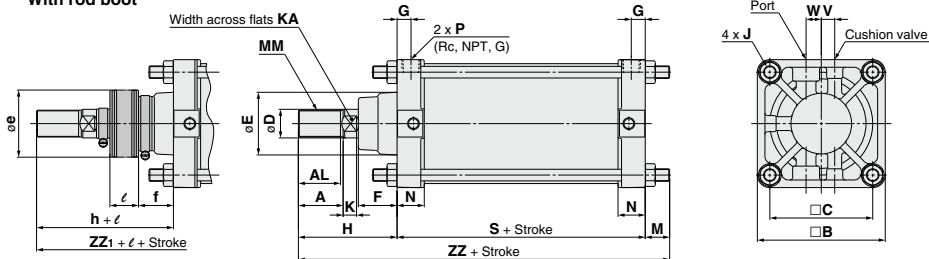

(mm)

Bore size (mm)	Stroke range (mm)	A	AL	□B	□C	D	E	F	G	J	V	W	K	KA	M	MM
125	Up to 1000	50	47	143	115	32	71	43	15	M14 x 1.5	15	17	15	27	27	M30 x 1.5
140	Up to 1000	50	47	157	128	32	71	43	15	M14 x 1.5	15	17	15	27	27	M30 x 1.5
160	Up to 1200	56	53	177	144	38	78.5	42	18	M16 x 1.5	15	20	17	34	30.5	M36 x 1.5

(mm)

Bore size (mm)	N	P	S	Without rod boot		With rod boot				
				H	ZZ	e	f	h	ℓ	ZZ ₁
125	30.5	1/2	98	110	235	75	40	133	1/2 stroke	258
140	30.5	1/2	98	110	235	75	40	133	1/2 stroke	258
160	34.5	3/4	106	120	256.5	75	40	141	1/2 stroke	277.5

* The minimum stroke with rod boot is 30 mm or more.

** For auto switch mounting position and its mounting height, refer to page 1238.

*** Refer to "Minimum Stroke for Auto Switch Mounting" on page 1239.

Foot: CS2YL

With rod boot

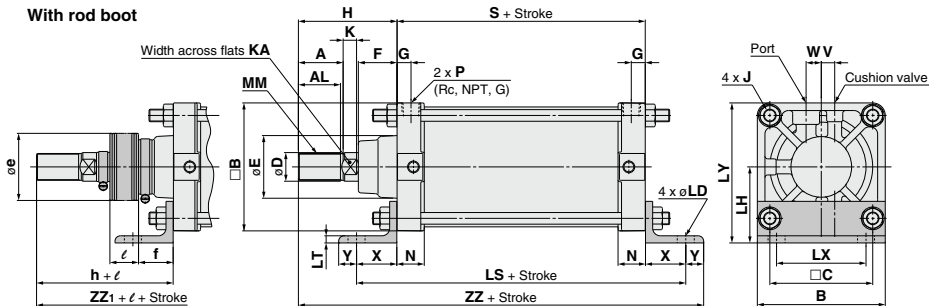

(mm)

Bore size (mm)	Stroke range (mm)	A	AL	□B	B	□C	D	E	F	G	J	V	W	K	KA	LD	LH	LS
125	Up to 1600	50	47	143	143	115	32	71	43	15	M14 x 1.5	15	17	15	27	19	85	188
140	Up to 1600	50	47	157	157	128	32	71	43	15	M14 x 1.5	15	17	15	27	19	100	188
160	Up to 1600	56	53	177	177	144	38	78.5	42	18	M16 x 1.5	15	20	17	34	19	106	206

(mm)

Bore size (mm)	LT	LX	LY	MM	N	P	S	X	Y	Without rod boot		With rod boot				
										H	ZZ	e	f	h	ℓ	ZZ ₁
125	8	100	156.5	M30 x 1.5	30.5	1/2	98	45	20	110	273	75	40	133	1/2 stroke	296
140	9	112	178.5	M30 x 1.5	30.5	1/2	98	45	30	110	283	75	40	133	1/2 stroke	306
160	9	118	194.5	M36 x 1.5	34.5	3/4	106	50	25	120	301	75	40	141	1/2 stroke	322

* The minimum stroke with rod boot is 30 mm or more.

** For auto switch mounting position and its mounting height, refer to page 1238.

*** Refer to "Minimum Stroke for Auto Switch Mounting" on page 1239.

- REA
- REB
- REC
- RZQ
- C
- X
- MQ
- RHC
- RZQ

- D
- X

Series CS2Y

Dimensions

Rod flange: CS2YF

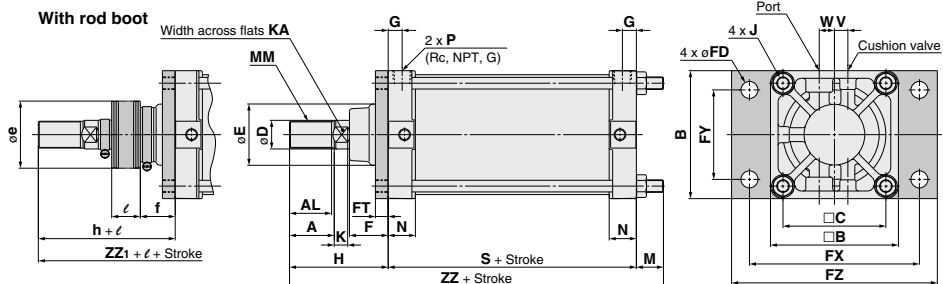

Bore size (mm)	Stroke range (mm)	A	AL	□B	B	□C	D	E	F	FD	FT	FX	FY	FZ	G	J	V
125	Up to 1600	50	47	143	145	115	32	71	43	19	14	190	100	230	15	M14 x 1.5	15
140	Up to 1600	50	47	157	160	128	32	71	43	19	20	212	112	255	15	M14 x 1.5	15
160	Up to 1600	56	53	177	180	144	38	78.5	42	19	20	236	118	275	18	M16 x 1.5	15

Bore size (mm)	W	K	KA	M	MM	N	P	S	Without rod boot		With rod boot				
									H	ZZ	e	f	h	ℓ	ZZ1
125	17	15	27	13	M30 x 1.5	30.5	1/2	98	110	221	75	40	133	1/2 stroke	244
140	17	15	27	13	M30 x 1.5	30.5	1/2	98	110	221	75	40	133	1/2 stroke	244
160	20	17	34	15	M36 x 1.5	34.5	3/4	106	120	241	75	40	141	1/2 stroke	262

* The minimum stroke with rod boot is 30 mm or more.
 ** For auto switch mounting position and its mounting height, refer to page 1238.
 *** Refer to "Minimum Stroke for Auto Switch Mounting" on page 1239.

Head flange: CS2YG

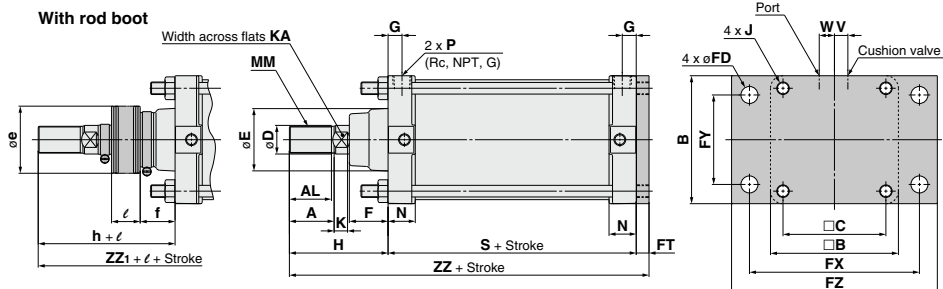

Bore size (mm)	Stroke range (mm)	A	AL	□B	B	□C	D	E	F	FD	FT	FX	FY	FZ	G	J	V
125	Up to 1000	50	47	143	145	115	32	71	43	19	14	190	100	230	15	M14 x 1.5	15
140	Up to 1000	50	47	157	160	128	32	71	43	19	20	212	112	255	15	M14 x 1.5	15
160	Up to 1200	56	53	177	180	144	38	78.5	42	19	20	236	118	275	18	M16 x 1.5	15

Bore size (mm)	W	K	KA	MM	N	P	S	Without rod boot		With rod boot				
								H	ZZ	e	f	h	ℓ	ZZ1
125	17	15	27	M30 x 1.5	30.5	1/2	98	110	222	75	40	133	1/2 stroke	245
140	17	15	27	M30 x 1.5	30.5	1/2	98	110	228	75	40	133	1/2 stroke	251
160	20	17	34	M36 x 1.5	34.5	3/4	106	120	246	75	40	141	1/2 stroke	267

* The minimum stroke with rod boot is 30 mm or more.
 ** For auto switch mounting position and its mounting height, refer to page 1238.
 *** Refer to "Minimum Stroke for Auto Switch Mounting" on page 1239.

Dimensions

Single clevis: CS2YC

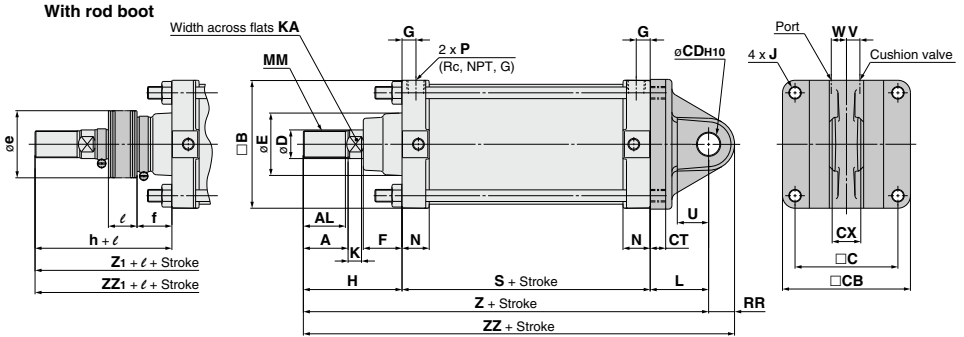

Double clevis: CS2YD

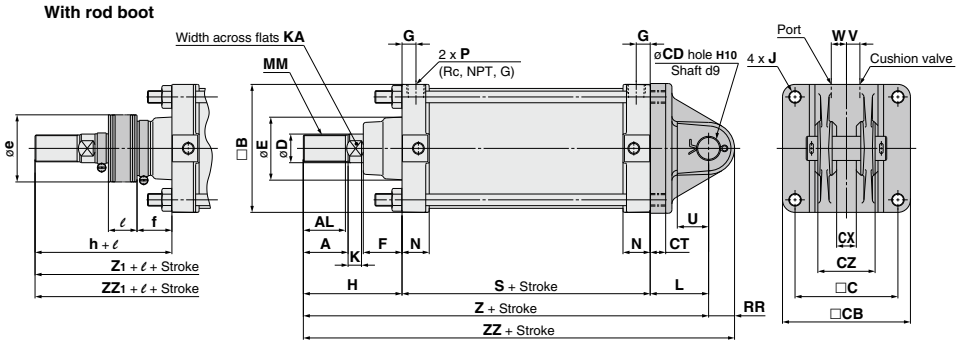

Bore size (mm)	Stroke range (mm)	A	AL	□B	□C	□CB	CDH10	CT	Single clevis			Double clevis			D	E	F	G	J	V	w
									CX	CX	CZ	CX	CX	CZ							
125	Up to 1000	50	47	143	115	145	25 ^{+0.084} ₀	17	32 ^{-0.1} _{0.3}	32 ^{+0.3} _{-0.1}	64 ⁰ _{-0.2}	32	71	43	15	M14 x 1.5	15	17			
140	Up to 1000	50	47	157	128	160	28 ^{+0.084} ₀	17	36 ^{-0.1} _{0.3}	36 ^{+0.3} _{-0.1}	72 ⁰ _{-0.2}	32	71	43	15	M14 x 1.5	15	17			
160	Up to 1200	56	53	177	144	180	32 ^{+0.100} ₀	20	40 ^{-0.1} _{-0.3}	40 ^{+0.3} _{-0.1}	80 ⁰ _{-0.2}	38	78.5	42	18	M16 x 1.5	15	20			

Bore size (mm)	K	KA	L	MM	N	P	S	U	RR	Without rod boot			With rod boot					
										H	Z	ZZ	e	f	h	ℓ	Z1	ZZ1
125	15	27	65	M30 x 1.5	30.5	1/2	98	35	29	110	273	302	75	40	133	1/2 stroke	296	325
140	15	27	75	M30 x 1.5	30.5	1/2	98	40	32	110	283	315	75	40	133	1/2 stroke	306	338
160	17	34	80	M36 x 1.5	34.5	3/4	106	45	36	120	306	342	75	40	141	1/2 stroke	327	363

* The minimum stroke with rod boot is 30 mm or more.
 ** For auto switch mounting position and its mounting height, refer to page 1238.
 *** Refer to "Minimum Stroke for Auto Switch Mounting" on page 1239.

- REA
- REB
- REC
- CY
- CX
- MQ
- RHC
- RZQ

- D
- X

Series CS2Y

Dimensions

Center trunnion: CS2YT

With rod boot

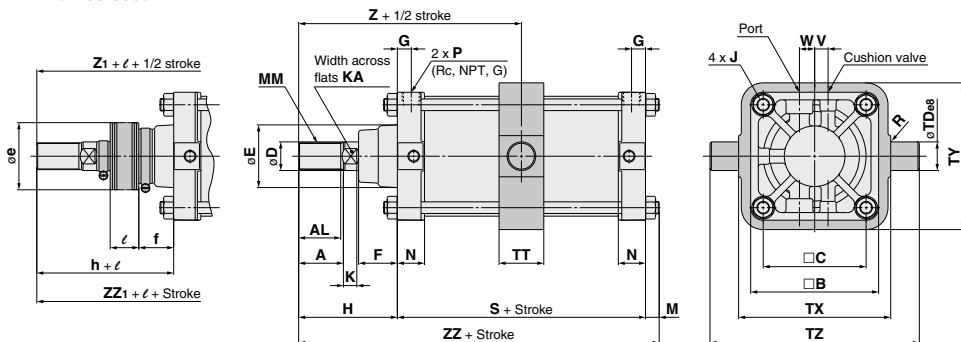

Bore size (mm)	Stroke range (mm)	A	AL	□B	□C	D	E	F	G	J	V	W	K	KA	M	MM	N
125	25 to 1000	50	47	143	115	32	71	43	15	M14 x 1.5	15	17	15	27	13	M30 x 1.5	30.5
140	30 to 1000	50	47	157	128	32	71	43	15	M14 x 1.5	15	17	15	27	13	M30 x 1.5	30.5
160	35 to 1200	56	53	177	144	38	78.5	42	18	M16 x 1.5	15	20	17	34	15	M36 x 1.5	34.5

Bore size (mm)	P	R	S	TD _{ø8}	TT	TX	TY	TZ	Without rod boot			With rod boot					
									H	Z	ZZ	e	f	h	ℓ	Z ₁	ZZ ₁
125	1/2	1	98	32 ^{-0.050} _{-0.088}	50	170	164	234	110	159	221	75	40	133	1/2 stroke	182	244
140	1/2	1.5	98	36 ^{-0.050} _{-0.088}	55	190	184	262	110	159	221	75	40	133	1/2 stroke	182	244
160	3/4	1.5	106	40 ^{-0.050} _{-0.088}	60	212	204	292	120	173	241	75	40	141	1/2 stroke	194	262

* The minimum stroke with rod boot is 30 mm or more for ø125, ø140 and 35 mm or more for ø160.

** For auto switch mounting position and its mounting height, refer to page 1238.

*** Refer to "Minimum Stroke for Auto Switch Mounting" on page 1239.

Series CS2Y Accessory Bracket

I Type Single Knuckle Joint*

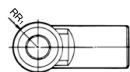
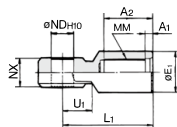

Material: Cast iron
(mm)

Part no.	Applicable bore size (mm)	A1	A2	E1	L1	MM	ND _{H10}	NX	RR1	U1
I-12A	125	8	54	46	100	M30 x 1.5	25 ^{+0.084} ₀	32 ^{-0.1} _{-0.3}	27	33
I-14A	140	8	54	48	105	M30 x 1.5	28 ^{+0.084} ₀	36 ^{-0.1} _{-0.3}	30	39
I-16A	160	8	60	55	110	M36 x 1.5	32 ^{+0.1} ₀	40 ^{-0.1} _{-0.3}	34	39

Knuckle Pin / Clevis Pin

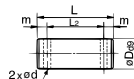

Material: Carbon steel
(mm)

Part no.	Applicable bore size (mm)	D _{d9}	L	L ₂	m	d	Applicable split pin
IY-12	125	25 ^{-0.065} _{-0.117}	79.5	69.5	5	4	ø4 x 40
IY-14	140	28 ^{-0.065} _{-0.117}	86.5	76.5	5	4	ø4 x 40
IY-16	160	32 ^{-0.080} _{-0.142}	94.5	84.5	5	4	ø4 x 40

* Split pin is included.

Y Type Double Knuckle Joint*

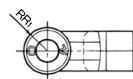
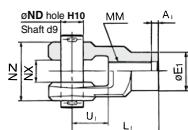

Material: Cast iron
(mm)

Part no.	Applicable bore size (mm)	A1	E1	L1	MM	ND _{H10}	NX	NZ	RR1	U1
Y-12A	125	8	46	100	M30 x 1.5	25 ^{+0.084} ₀	32 ^{+0.3} _{-0.1}	64 ^{-0.1} _{-0.3}	27	42
Y-14A	140	8	48	105	M30 x 1.5	28 ^{+0.084} ₀	36 ^{+0.3} _{-0.1}	72 ^{-0.1} _{-0.3}	30	47
Y-16A	160	8	55	110	M36 x 1.5	32 ^{+0.1} ₀	40 ^{+0.3} _{-0.1}	80 ^{-0.1} _{-0.3}	34	46

- * Use a single knuckle joint or a double knuckle joint individually.
(Screw it entirely over the rod end threads and tighten it.)
- * Extend the dimensions of A, H, when using a single/double knuckle joint together with a rod end nut.
(To extend dimensions A, H, refer to the below table, and specify the product as made-to-order -XA0.)
- * A pin and split pin are included with the double knuckled joint.

Rod End Nut

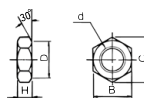

Material: Rolled steel
(mm)

Part no.	Applicable bore size (mm)	d	H	B	C	D
NT-12	125, 140	M30 x 1.5	18	46	53.1	44
NT-16	160	M36 x 1.5	21	55	63.5	53

● "Made to order" with rod end bracket (-XC86) is available when ordering cylinders and accessories together. Please refer to page 2147 for details.

Single/Double Knuckle Joint

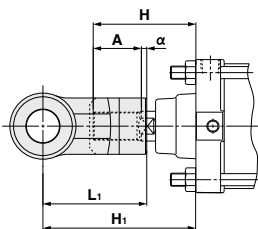

(mm)

Bore size (mm)	Symbol	H	A	α	L ₁	H ₁	Applicable knuckle joint part number	
							I type single knuckle	Y type double knuckle
125		110	50	3.5	100	156.5	I-12A	Y-12A
140		110	50	3.5	105	161.5	I-14A	Y-14A
160		120	56	3.5	110	170.5	I-16A	Y-16A

A, H Dimensions when Mounting a Single/Double Knuckle Joint together with a Rod End Nut

Bore size (mm)	A	H
125	65	125
140	65	125
160	76	140

REA

REB

REC

COY

COX

MQ

RHC

RZQ

D-□

-X□

Auto Switch Mounting 1

Auto Switch Proper Mounting Position (Detection at stroke end) and Its Mounting Height

<Band mounting>

D-A3□ type

D-G3/K3 type

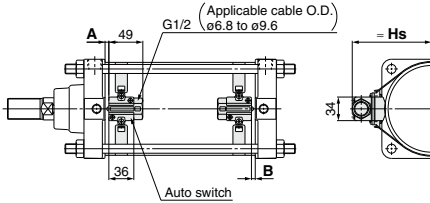

D-A44 type

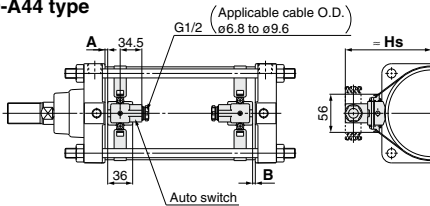

* The indicator light faces the inside.

<Tie-rod mounting>

D-A9□/A9□V type

D-M9□/M9□V type

D-M9□W/M9□WV type

D-M9□A/M9□AV type

D-Z7□/Z80 type

D-Y59□/Y69□/Y7P/Y7PV type

D-Y7□W/Y7□WV type

D-Y7BA type

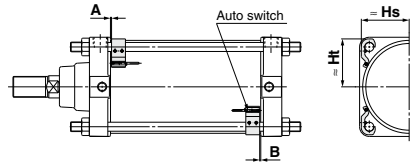

D-A5□/A6□ type

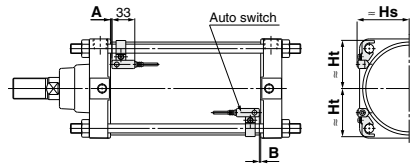

D-F5□/J5□/D-F5NT type

D-F5BA/F59F type

D-F5□W/J59W type

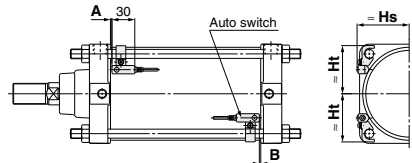

Auto Switch Proper Mounting Position

(mm)

Auto switch model	D-A9□ D-A9□V		D-M9□ D-M9□V D-M9□W D-M9□WV D-M9□A D-M9□AV		D-Z7□/Z80 D-Y5□/Y6□ D-Y7P/Y7PV D-Y7□W D-Y7□WV D-Y7BA		D-A5□ D-A6□ D-A3□ D-A44 D-G39 D-K39		D-A59W		D-F5□W D-J59W D-F5BA D-F5□ D-J5□ D-F59F		D-F5NT	
	A	B	A	B	A	B	A	B	A	B	A	B	A	B
Bore size 125	9	8	13	12	6.5	5.5	3	2	7	6	9.5	8.5	14.5	13.5
140	9	8	13	12	6.5	5.5	3	2	7	6	9.5	8.5	14.5	13.5
160	9	8	13	12	6.5	5.5	3	2	7	6	9.5	8.5	14.5	13.5

* Provided as guidelines for auto switch proper mounting position (detection at stroke end). When setting an auto switch, confirm the operation and adjust its mounting position.

Auto Switch Mounting Height

(mm)

Auto switch model	D-A9□ D-A9□V D-M9□ D-M9□W D-M9□A		D-M9□V D-M9□WV D-M9□AV		D-Z7□/Z80 D-Y5□/Y6□ D-Y7P D-Y7PV D-Y7□W D-Y7□WV D-Y7BA		D-A3□ D-G39 D-K39		D-A44		D-A5□ D-A6□ D-A59W		D-F5□ D-J5□ D-F5□W D-J59W D-F5BA D-F59F D-F5NT	
	Hs	Ht	Hs	Ht	Hs	Ht	Hs	Ht	Hs	Ht	Hs	Ht	Hs	Ht
Bore size 125	69	69.5	71.5	69.5	69	69.5	116		126		75.5	69.5	74.5	70
140	76	76	77.5	76	76	76	124		134		81	76.5	80	76.5
160	85	85	86	85	85	85	134.5		144.5		89	87.5	88	87.5

Minimum Stroke for Auto Switch Mounting

n: Number of auto switches (mm)

Auto switch model	Number of auto switches mounted	Mounting brackets other than center trunnion	Center trunnion			
			ø125	ø140	ø160	
D-A9□	With 2 pcs. (Different surfaces, Same surface), With 1 pc.	15	100	105	110	
	With n pcs.	$15 + 40 \frac{(n-2)}{2}$ (n = 2, 4, 6, 8...)	$100 + 40 \frac{(n-4)}{2}$ (n = 4, 8, 12, 16...)	$105 + 40 \frac{(n-4)}{2}$ (n = 4, 8, 12, 16...)	$110 + 40 \frac{(n-4)}{2}$ (n = 4, 8, 12, 16...)	
D-A9□V	With 2 pcs. (Different surfaces, Same surface), With 1 pc.	10	75	80	85	
	With n pcs.	$10 + 30 \frac{(n-2)}{2}$ (n = 2, 4, 6, 8...)	$75 + 30 \frac{(n-4)}{2}$ (n = 4, 8, 12, 16...)	$80 + 30 \frac{(n-4)}{2}$ (n = 4, 8, 12, 16...)	$85 + 30 \frac{(n-4)}{2}$ (n = 4, 8, 12, 16...)	
D-M9□ D-M9□W	With 2 pcs. (Different surfaces, Same surface), With 1 pc.	15	105	110	115	
	With n pcs.	$15 + 40 \frac{(n-2)}{2}$ (n = 2, 4, 6, 8...)	$105 + 40 \frac{(n-4)}{2}$ (n = 4, 8, 12, 16...)	$110 + 40 \frac{(n-4)}{2}$ (n = 4, 8, 12, 16...)	$115 + 40 \frac{(n-4)}{2}$ (n = 4, 8, 12, 16...)	
D-M9□V D-M9□WV	With 2 pcs. (Different surfaces, Same surface), With 1 pc.	10	80	85	90	
	With n pcs.	$10 + 30 \frac{(n-2)}{2}$ (n = 2, 4, 6, 8...)	$80 + 30 \frac{(n-4)}{2}$ (n = 4, 8, 12, 16...)	$85 + 30 \frac{(n-4)}{2}$ (n = 4, 8, 12, 16...)	$90 + 30 \frac{(n-4)}{2}$ (n = 4, 8, 12, 16...)	
D-M9□A	With 2 pcs. (Different surfaces, Same surface), With 1 pc.	20	115	120		
	With n pcs.	$20 + 40 \frac{(n-2)}{2}$ (n = 2, 4, 6, 8...)	$115 + 40 \frac{(n-4)}{2}$ (n = 4, 8, 12, 16...)	$120 + 40 \frac{(n-4)}{2}$ (n = 4, 8, 12, 16...)		
D-M9□AV	With 2 pcs. (Different surfaces, Same surface), With 1 pc.	15	90	95		
	With n pcs.	$15 + 30 \frac{(n-2)}{2}$ (n = 2, 4, 6, 8...)	$90 + 30 \frac{(n-4)}{2}$ (n = 4, 8, 12, 16...)	$95 + 30 \frac{(n-4)}{2}$ (n = 4, 8, 12, 16...)		
D-A5□/A6□ D-A59W D-F5□/J5□ D-F5□W D-J59W D-F5BA D-F59F	With 2 pcs. (Different surfaces, Same surface), With 1 pc.	25	125	135		
	With n pcs. (Same surface)	$25 + 55 \frac{(n-2)}{2}$ (n = 2, 4, 6, 8...)	$125 + 55 \frac{(n-4)}{2}$ (n = 4, 8, 12, 16...)	$135 + 55 \frac{(n-4)}{2}$ (n = 4, 8, 12, 16...)		
D-F5NT	With 2 pcs. (Different surfaces, Same surface), With 1 pc.	35	145	155		
	With n pcs. (Same surface)	$35 + 55 \frac{(n-2)}{2}$ (n = 2, 4, 6, 8...)	$145 + 55 \frac{(n-4)}{2}$ (n = 4, 8, 12, 16...)	$155 + 55 \frac{(n-4)}{2}$ (n = 4, 8, 12, 16...)		
D-A3□ D-G39 D-K39	With 2 pcs.	Different surfaces	35	110		
		Same surface	100			
	With n pcs.	Different surfaces	$35 + 30(n-2)$	$110 + 30(n-2)$ (n = 2, 4, 6, 8...)		
		Same surface	$100 + 100(n-2)$	$110 + 100(n-2)$ (n = 2, 4, 6, 8...)		
D-A44	With 2 pcs.	Different surfaces	35	110		
		Same surface	55			
	With n pcs.	Different surfaces	$35 + 30(n-2)$	$110 + 30(n-2)$ (n = 2, 4, 6, 8...)		
		Same surface	$55 + 55(n-2)$	$110 + 50(n-2)$ (n = 2, 4, 6, 8...)		
	With 1 pc.		15	110		
	D-Z7□ D-Z80 D-Y59□ D-Y7P D-Y7□W	With 2 pcs. (Different surfaces, Same surface), With 1 pc.	15	105	110	115
With n pcs.		$15 + 40 \frac{(n-2)}{2}$ (n = 2, 4, 6, 8...)	$105 + 40 \frac{(n-4)}{2}$ (n = 4, 8, 12, 16...)	$110 + 40 \frac{(n-4)}{2}$ (n = 4, 8, 12, 16...)	$115 + 40 \frac{(n-4)}{2}$ (n = 4, 8, 12, 16...)	
With 2 pcs. (Different surfaces, Same surface), With 1 pc.		10	90	95	100	
With n pcs.		$10 + 30 \frac{(n-2)}{2}$ (n = 2, 4, 6, 8...)	$90 + 30 \frac{(n-4)}{2}$ (n = 4, 8, 12, 16...)	$95 + 30 \frac{(n-4)}{2}$ (n = 4, 8, 12, 16...)	$100 + 30 \frac{(n-4)}{2}$ (n = 4, 8, 12, 16...)	
D-Y7BA	With 2 pcs. (Different surfaces, Same surface), With 1 pc.	20	115	120	125	
	With n pcs.	$20 + 45 \frac{(n-2)}{2}$ (n = 2, 4, 6, 8...)	$115 + 45 \frac{(n-4)}{2}$ (n = 4, 8, 12, 16...)	$120 + 45 \frac{(n-4)}{2}$ (n = 4, 8, 12, 16...)	$125 + 45 \frac{(n-4)}{2}$ (n = 4, 8, 12, 16...)	

- REA
- REB
- REC
- CQY
- CQX
- MQ
- RHC
- RZQ
- D-□
- X□

Auto Switch Mounting 2

Operating Range

Auto switch model	Bore size (mm)		
	125	140	160
D-A9□/A9□V	12	12.5	11.5
D-M9□/M9□V D-M9□W/M9□WV D-M9□A/M9□AV	6	6.5	6.5
D-Z7□/Z80	14	14.5	13
D-A3□/A44 D-A5□/A6□	10	10	10
D-A59W	17	17	17
D-Y59□/Y69□ D-Y7P/Y7PV D-Y7□W/Y7□WV D-Y7BA	12	13	7
D-F5□/J5□/F5□W D-J59W/F5BA D-F5NT/F59F	5	5	5.5
D-G39/K39	11	11	10

* Since this is a guideline including hysteresis, not meant to be guaranteed.
(Assuming approximately ±30% dispersion.)
There may be the case it will vary substantially depending on an ambient environment.

Auto Switch Mounting Bracket Part No.

Auto switch model	Bore size (mm)		
	ø125	ø140	ø160
D-A9□/A9□V D-M9□/M9□V D-M9□W/M9□WV D-M9□A/M9□AV	BS5-125	BS5-125	BS5-160
D-A5□/A6□ D-A59W D-F5□/J5□ D-F5NT D-F5□W/J59W D-F5BAL/F59F	BT-12	BT-12	BT-16
D-A3□/A44 D-G39/K39	BS1-125	BS1-140	BS1-160
D-Z7□/Z80 D-Y59□/Y69□ D-Y7P/Y7PV D-Y7□W/Y7□WV D-Y7BA	BS4-125	BS4-125	BS4-160

[Mounting screws set made of stainless steel]

The following set of mounting screws made of stainless steel (including set screws) is also available. Use it in accordance with the operating environment. (Please order the auto switch mounting bracket separately, since it is not included.)

BBA1: For D-A5, A6, F5, J5 type

"D-F5BA" auto switch is set on the cylinder with the stainless steel screws above when shipped.

When only an auto switch is shipped independently, "BBA1" screws are attached.

(Note) When using the D-M9□A/M9□AV or Y7BA model, do not use the steel set screw which is included with the auto switch mounting bracket in the above table (BS5-□□□, BS4-□□□). Please separately prepare the stainless steel screw set (BBA1), and select and use the M4 x 8L stainless steel set screw included in BBA1.

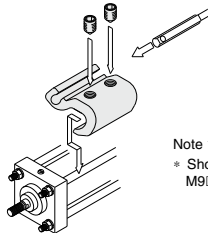

Note 1) Refer to page 1997 for the details of BBA1 screws.

* Shows an example of mounting the D-A9□(V), M9□(V), M9□A(V) model.

Other than the applicable auto switches listed in "How to Order", the following auto switches can be mounted. For detailed specifications, refer to pages 1893 to 2007.

Type	Model	Electrical entry (Direction)	Features
Reed auto switch	D-A90V	Grommet (Perpendicular)	Without indicator light
	D-A93V, A96V		
	D-Z73, Z76	Grommet (in-line)	Without indicator light
	D-A53, A56		
	D-A67		
Solid state auto switch	D-Z80	Grommet (in-line)	2-color indication Water resistant (2-color indication) With timer
	D-F59, F5P, J59		
	D-Y59A, Y59B, Y7P		
	D-F59W, F5PW, J59W		
	D-Y7NW, Y7PW, Y7BW		
	D-F5BAL, Y7BA		
	D-F5NT	Grommet (Perpendicular)	2-color indication Water resistant (2-color indication)
	D-M9NV, M9PV, M9BV		
	D-Y69A, Y69B, Y7PV		
	D-M9NWV, M9PWV, M9BWV		
	D-Y7NWV, Y7PWV, Y7BWV		
	D-M9NAV, M9PAV, M9BAV		

* With pre-wired connector is available for solid state auto switches. For details, refer to pages 1960 to 1961.

* Normally closed (NC = b contact), solid state switches (D-F9G, F9H, Y7G, Y7H type) are also available. For details, refer to pages 1911 and 1913.



Smooth Cylinder Specific Product Precautions 1

Be sure to read before handling.

Refer to front matter 39 for Safety Instructions and pages 3 to 12 for Actuator and Auto Switch Precautions.

Recommended Pneumatic Circuit

Refer to the diagrams below when controlling speed with the smooth cylinder.

⚠ Warning

Horizontal operation (Speed control)

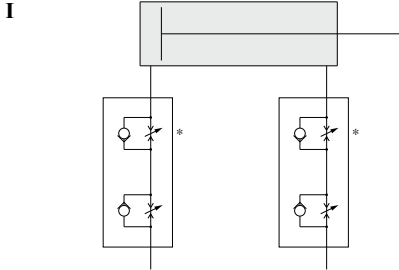

Dual speed controller

Speed is controlled by meter-out circuit. Using concurrently the meter-in circuit can alleviate the stick-slip. More stable low speed operation can be achieved than meter-in circuit alone.

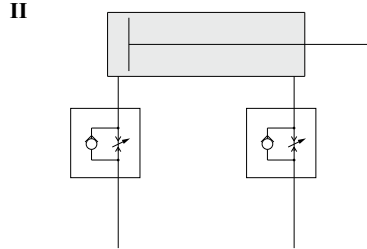

Meter-in speed controller

Meter-in speed controllers can reduce lurching while controlling the speed. The two adjustment needles facilitate adjustment.

Vertical operation (Speed control)

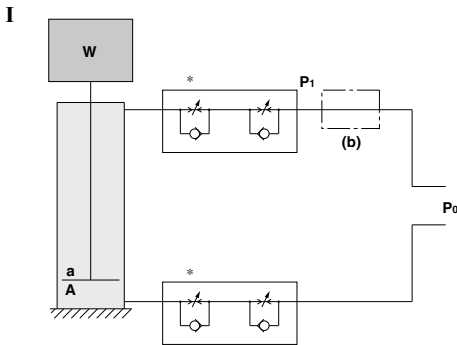

- (1) Speed is controlled by meter-out circuit. Using concurrently the meter-in circuit can alleviate the stick-slip.*
- (2) Depending on the size of the load, installing a regulator with check valve at position (b) can reduce lurching during descent and operation delay during ascent.
As a guide,
when $W + P_0a > P_0A$,
adjust P_1 to make $W + P_1a = P_0A$.

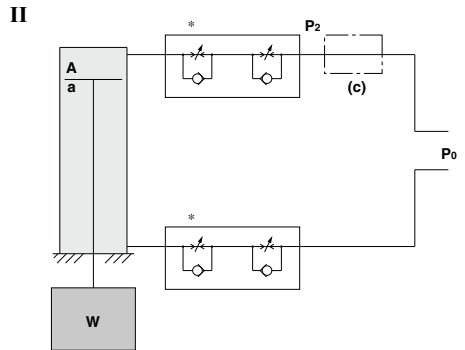

- (1) Speed is controlled by meter-out circuit. Using concurrently the meter-in circuit can alleviate the stick-slip.*
- (2) Installing a regulator with check valve at position (c) can reduce lurching during descent and operation delay during ascent.
As a guide,
adjust P_2 to make $W + P_2A = P_0a$.

W: Load (N) P₀: Operating pressure (MPa) P₁, P₂: Reduced pressure (MPa) a: Rod side piston area (mm²) A: Head side piston area (mm²)

REA
REB
REC
C□Y
C□X
MQ
RHC
RZQ

D-□
-X□



Smooth Cylinder Specific Product Precautions 2

Be sure to read before handling.
Refer to front matter 39 for Safety Instructions and pages 3 to 12 for Actuator
and Auto Switch Precautions.

Lubricant

Caution

1. **Operate without lubrication.**
Lubrication may cause malfunction.

2. **Do not use grease not specified by SMC.**

Using grease other than that specified may cause malfunction.

- Order using the following part numbers when only maintenance grease is needed.

Grease

Volume	Part no.
5 g	GR-L-005
10 g	GR-L-010
150 g	GR-L-150

3. **Do not wipe off grease from the sliding part of the air cylinder.**

Wiping grease from the sliding part of the air cylinder forcefully may cause malfunction.

Air Source

Caution

1. **Take measure to prevent pressure fluctuations.**
Pressure fluctuations may cause malfunction.

Low Speed Cylinder

Series CJ2X/CUX/CQSX/CQ2X/CM2X

ø10, ø16 ø10 to ø32 ø12 to ø25 ø32 to ø100 ø20 to ø40

Air Cylinder Series CJ2X



Bore size (mm)	Minimum operating pressure (MPa)	Minimum operating piston speed (mm/s)
10, 16	0.06	1

Page

1246

Free Mount Cylinder Series CUX



Bore size (mm)	Minimum operating pressure (MPa)	Minimum operating piston speed (mm/s)
10, 16	0.06	1
20, 25, 32	0.05	0.5

1256

Compact Cylinder Series CQSX



Bore size (mm)	Minimum operating pressure (MPa)	Minimum operating piston speed (mm/s)
12, 16	0.03	1
20, 25	0.025	0.5

1261

Compact Cylinder Series CQ2X



Bore size (mm)	Minimum operating pressure (MPa)	Minimum operating piston speed (mm/s)
32, 40	0.025	0.5
50, 63, 80, 100	0.01	0.5

1268

Air Cylinder Series CM2X



Bore size (mm)	Minimum operating pressure (MPa)	Minimum operating piston speed (mm/s)
20, 25, 32, 40	0.025	0.5

1280

Clean Series

Compact Cylinder Series 10-/11-CQSX



Compact Cylinder Series 10-/11-CQ2X



Air Cylinder Series 10-/11-CM2X



REA

REB

REC

Y

X

MQ

RHC

RZQ

D-

-X

Low Speed Cylinder

Improved low friction characteristics (CM2X, CQSX, CQ2X)
Minimum operating pressure is reduced in half (compared to previous version).
Stabilization of thrust has been realized.

Measurement circuit of cylinder output relative to supply pressure

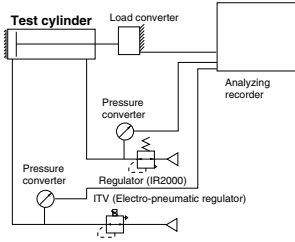

CQ2B40-75D (Standard)

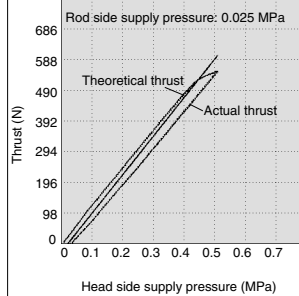

CQ2XB40-75D (Low speed cylinder)

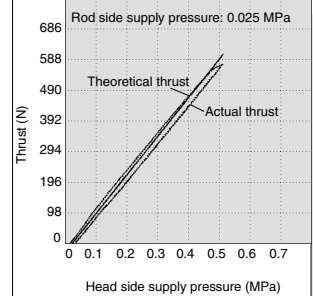

Stable low speed operation even at 0.5 mm/s (1 mm/s for $\phi 16$ or smaller) is achieved.
Operates smoothly with minimal stick-slip.

CJ2XB10-60

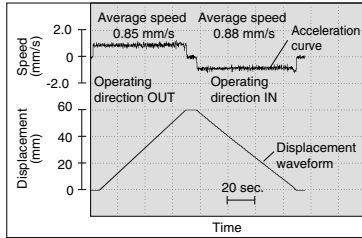

CQSXB20-20D

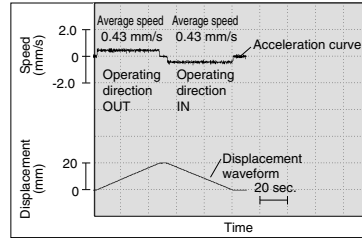

Note 1) Average speed is what the stroke is divided by piston rod's transit time.
 Note 2) The OUT operating direction is considered to be positive with regard to speed.

Data conditions • Working fluid Air
 • Mounting orientation Horizontal no-load
 • Operating pressure 0.35 MPa
 • Operating circuit Meter-in

Possible to transfer a workpiece which must avoid shocks at lower speeds.
Smooth start with a little ejection even after being rendered for hours.

The dimensions of all models are the same as those of standard cylinders.

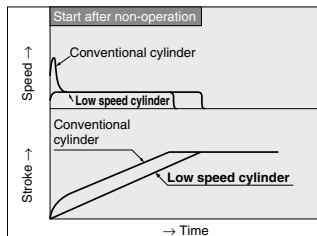

Clean room specification has been added. (10-/11-CQSX, CQ2X, CM2X)

Particulate generation data for microspeed cylinder with clean room specifications are measured using the following test method.

[Example of test method]

The test sample is in place in an acrylic chamber. The chamber is set up on a Class 100 clean bench. The solenoid valve is operated while supplying a volume of clean air equal to the intake volume of a laser dust monitor (28.3 L/min). The amount of particle generation is measured for a specific number of operating cycles.

Measuring Conditions

Chamber volume	15 L
Purity of air supplied to chamber	Same quality as supply air
Laser dust monitor	Hitachi Electronics Engineering Corporation TS-6200 Min. measurable particle dia.: 0.1 μm Intake rate: 28.3 L/min
Laser dust monitor setting conditions	Sampling time: 5 min Interval time: 55 min
Cylinder operating conditions	Operating frequency: 30 cpm Average piston speed: 100 mm/s Mounting: Horizontal no-load Supply pressure: 0.5 MPa

10-CQSXB20-50

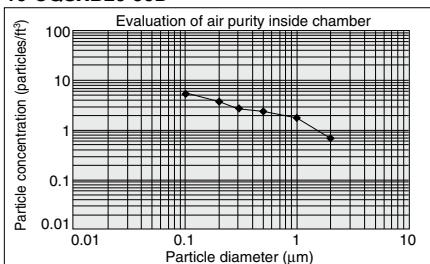

10-CM2XB20-50

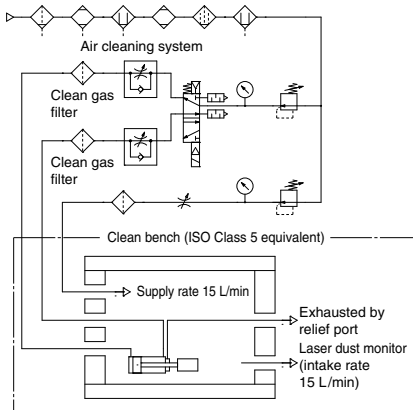
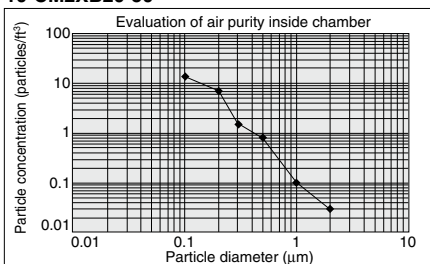

Particle generation measuring circuit

* The symbol for the cylinder is SMC original symbol.

REA

REB

REC

Y

X

MQ

RHC

RZQ

D

X

Low Speed Cylinder Double Acting, Single Rod Series **CJ2X** ø10, ø16

How to Order

Bore size

10	10 mm
16	16 mm

Standard stroke (mm)

ø10	15, 30, 45, 60, 75, 100, 125, 150
ø16	15, 30, 45, 60, 75, 100, 125, 150, 175, 200

* Intermediate stroke other than above is manufactured upon receipt of order.

Mounting style

B	Basic style
L	Axial foot style
F	Rod side flange style
D	Double clevis style

Built-in Magnet Cylinder Model

Suffix the symbol "A" (Rail mounting style) or "B" (Band mounting style) to the end of part number for cylinder with auto switch.

Example	Rail mounting style	CDJ2XB10-45-A
	Band mounting style	CDJ2XB16-60-B

* For the rail mounting type, screws and nuts for two auto switches are included in the rail.

With auto switch

With auto switch (Built-in magnet)

Low speed cylinder

Port location on head cover

Bore size (mm)	ø10, ø16
Symbol	Nil
Nil	Perpendicular to axis
R	Axial direction

Auto switch

Nil	Without auto switch
-----	---------------------

* For the applicable auto switch model, refer to the table below.

Number of auto switches

Nil	2 pcs.
S	1 pc.
n	"n" pcs.

Auto switch mounting bracket ^(Note)

Note) This symbol is indicated when the D-A9□ or M9□ type auto switch is specified. This mounting bracket does not apply to other auto switches (D-C7□ and H7□, etc.) (Nil)

Applicable Auto Switches ^(Refer to pages 1893 to 2007 for further information on auto switches.)

Type	Special function	Electrical entry	Indicator light	Wiring (Output)	Load voltage		Auto switch model				Lead wire length (m)				Pre-wired connector	Applicable load					
					DC	AC	Band mounting		Rail mounting		0.5 (Nil)	1 (M)	3 (L)	5 (Z)			None (N)				
							Perpendicular	In-line	Perpendicular	In-line											
Solid state auto switch	—	Grommet	—	3-wire (NPN)	5 V, 12 V	—	M9NV	M9N	—	—	●	●	●	○	○	IC circuit					
							—	—	F7NV	F7N	●	●	●	○	○						
				M9PV			M9P	—	—	●	●	●	○	○							
		—		—			F7PV	F7P	●	●	●	○	○								
		M9BV		M9B			—	—	●	●	●	○	○								
		—		—			F7BV	F7B	●	●	●	○	○								
	Diagnostic indication (2-color indication)	Connector	Yes	24 V	3-wire (NPN)	5 V, 12 V	—	—	—	—	—	●	●	●	○	○	IC circuit				
								M9NWV	M9NW	—	—	●	●	●	○	○					
					—			—	F7NWV	F7W	●	●	●	○	○						
		3-wire (PNP)			—			—	—	●	●	●	○	○							
		—			—			F7PW	—	●	●	●	○	○							
		—			—			H7C	J79C	●	●	●	○	○							
Water resistant (2-color indication)	Grommet	No	24 V	2-wire	5 V, 12 V	—	M9BWV	M9BW	—	—	●	●	●	○	○	—					
							—	—	F7BWV	J79W	●	●	●	○	○						
				3-wire (NPN)			—	—	—	○	○	○	○	○							
	3-wire (PNP)			—			—	—	○	○	○	○	○								
	2-wire			—			—	—	○	○	○	○	○								
	4-wire (NPN)			—			—	—	○	○	○	○	○								
Reed auto switch	—	Grommet	Yes	3-wire (NPN equivalent)	24 V	12 V	A96V	A96	—	A76H	●	●	—	—	—	IC circuit					
							—	—	A72	A72H	●	●	—	—	—						
				—			—	A93V	A93	A73	A73H	●	●	●	—		—				
		—		—			A90V	A90	A80	A80H	●	●	●	—	—						
		—		—			C73C	A73C	—	—	●	●	●	●	—						
	Diagnostic indication (2-color indication)	Connector		No			24 V	2-wire	24 V or less	—	—	—	C80C	A80C	—		—	●	●	●	IC circuit
											—	—	A79W	—	●		●	—	—	—	
											—	—	—	—	●		●	—	—	—	
		—									—	—	—	●	●		—	—	—		
		—									—	—	—	●	●		—	—	—		

** Water resistant type auto switches can be mounted on the above models, but in such case SMC cannot guarantee water resistance. Consult with SMC regarding water resistant types with the above model numbers.

* Lead wire length symbols: 0.5 m Nil (Example) M9NV
 1 m M (Example) M9NW
 3 m L (Example) M9NWV
 5 m Z (Example) M9NWZ

* Since there are other applicable auto switches than listed, refer to page 1255 for details.
 * For details about auto switches with pre-wired connector, refer to pages 1960 and 1961.

* Solid state auto switches marked with "O" are produced upon receipt of order.

* D-A9□/M9□/M9□W/A7□□/A80□/F7□□/□□□□ auto switches are shipped together (not assembled). (When D-A9□/M9□/M9□W are specified, only auto switch mounting brackets are assembled before shipped.)

* D-C7□□/C80□/□□ auto switches are assembled at the time of shipment.

* Order auto switch mounting brackets separately when D-A9□□/M9□□(V)/M9□□(V)/M9□□(V) types are mounted with a rail. Refer to page 1255 for details.



Symbol

Double acting, Single rod/Rubber bumper

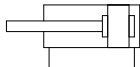

⚠ Precautions

Be sure to read before handling.
Refer to front matter 39 for Safety Instructions and pages 3 to 12 for Actuator and Auto Switch Precautions.

Mounting

⚠ Caution

- During installation, secure the rod cover and tighten by applying an appropriate tightening force to the retaining nut or to the rod cover body.
If the head cover is secured or the head cover is tightened, the cover could rotate, leading to the deviation.
- Proper tightening torque for mounting thread should be within the range specified. Apply a Loctite® (no. 242 Blue) for mounting thread.

Bore size (mm)	Proper tightening torque for mounting thread (N·m) (tightening torque for mounting nut)
10	3.0 to 3.2
16	5.4 to 5.9

- To remove and install the retaining ring for the knuckle pin or the clevis pin, use an appropriate pair of pliers (tool for installing a type C retaining ring).
Especially with $\phi 10$, use ultra thin pliers, such as Super Tool Corp., CSM-07A.
- For the auto switch mounting rail, do not remove the pre-equipped rail. Since the mounting thread is drilled through inside a the cylinder, it will result in air leakage.

Operating Precautions

⚠ Warning

- It might not be able to control by meter-out at a low speed operation.

⚠ Caution

- For Series CJ2X, 0.1 N L/min is the values at maximum in terms of its construction and there is internal leakage (ANR).

Specifications

Bore size (mm)	10	16
Action	Double acting, Single rod	
Fluid	Air	
Proof pressure	1.05 MPa	
Maximum operating pressure	0.7 MPa	
Minimum operating pressure	0.06 MPa	
Ambient and fluid temperature	Without auto switch: -10 to 70°C (No freezing) With auto switch: -10 to 60°C (No freezing)	
Cushion	Rubber bumper (Standard equipment)	
Lubrication	Not required (Non-lube)	
Stroke length tolerance	$^{+1.0}_0$	
Piston speed	1 to 300 mm/s	
Allowable kinetic energy	$\phi 10$	0.035 J
	$\phi 16$	0.090 J

Standard Stroke

Bore size (mm)	Standard stroke (mm)
10	15, 30, 45, 60, 75, 100, 125, 150
16	15, 30, 45, 60, 75, 100, 125, 150, 175, 200

* Manufacture of intermediate strokes at 1 mm intervals is possible. (Spacers are not used.)

Mounting Style and Accessory

Mounting		Basic style	Axial foot style	Rod side flange style	Double* clevis style
Standard equipment	Mounting nut	●	●	●	—
	Rod end nut	●	●	●	●
	Clevis pin	—	—	—	●
Option	Single knuckle joint	○	○	○	○
	Double knuckle joint*	○	○	○	○
	T-bracket	—	—	—	○

* Pin and retaining ring are shipped together with double clevis and double knuckle joint.
●...Supplied with the product.
○...Please order separately.

Port Location on Head Cover

For basic style, the port position in a head cover is available either perpendicular to the axis or in-line with the cylinder axis.



Mounting Bracket Part No.

Mounting bracket	Bore size (mm)	
	10	16
Foot bracket	CJ-L010B	CJ-L016B
Flange bracket	CJ-F010B	CJ-F016B
T-bracket*	CJ-T010B	CJ-T016B

* T-bracket is used with double clevis (D).

REA

REB

REC

C□Y

C□X

MQ

RHC

RZQ

D-□

X-□

Series CJ2X

Basic Style (B)

CJ2XB **Bore size** – **Stroke** **Port location on head cover**

CJ2XB10, 16

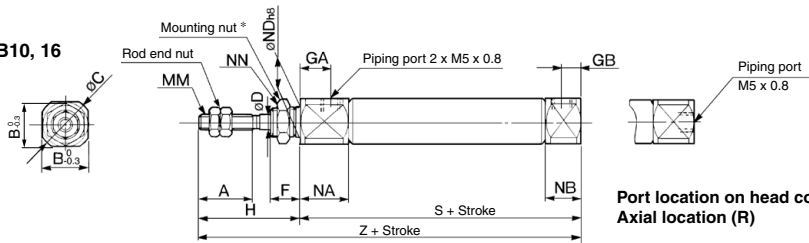

Port location on head cover:
Axial location (R)

* For details of the mounting nut, refer to page 1250.

(mm)

Bore size (mm)	A	B	C	D	F	GA	GB	H	MM	NA	NB	NDh8	NN	S	T	Z
10	15	12	14	4	8	8	5	28	M4 x 0.7	12.5	9.5	8 ^h _{-0.022}	M8 x 1.0	46	—	74
16	15	18.3	20	5	8	8	5	28	M5 x 0.8	12.5	9.5	10 ^h _{-0.022}	M10 x 1.0	47	—	75

Axial Foot Style (L)

CJ2XL **Bore size** – **Stroke** **Port location on head cover**

CJ2XL10, 16

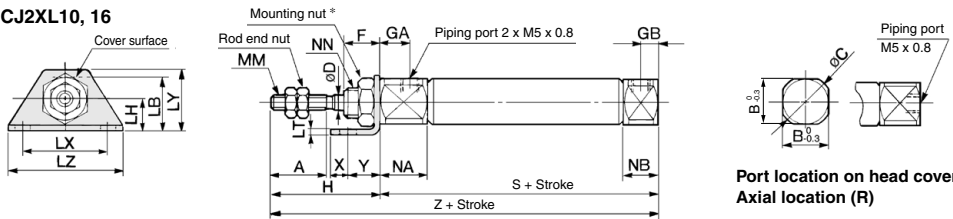

Port location on head cover:
Axial location (R)

* For details of the mounting nut, refer to page 1250.

Bore size (mm)	A	B	C	D	F	GA	GB	H	LB	LC	LH	LT	LX	LY	LZ	MM	NA	NB	NN	S	T	X	Y	Z
10	15	12	14	4	8	8	5	28	15	4.5	9	1.6	24	16.5	32	M4 x 0.7	12.5	9.5	M8 x 1.0	46	—	5	7	74
16	15	18.3	20	5	8	8	5	28	23	5.5	14	2.3	33	25	42	M5 x 0.8	12.5	9.5	M10 x 1.0	47	—	6	9	75

Rod Side Flange Style (F)

CJ2XF Bore size – Stroke Port location on head cover

CJ2XF10, 16

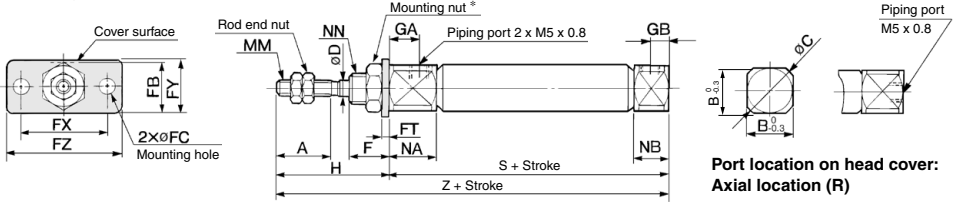

* For details of the mounting nut, refer to page 1250.

Bore size (mm)	A	B	C	D	F	FB	FC	FT	FX	FY	FZ	GA	GB	H	MM	NA	NB	NN	S	T	Z
10	15	12	14	4	8	13	4.5	1.6	24	14	32	8	5	28	M4 x 0.7	12.5	9.5	M8 x 1.0	46	—	74
16	15	18.3	20	5	8	19	5.5	2.3	33	20	42	8	5	28	M5 x 0.8	12.5	9.5	M10 x 1.0	47	—	75

Double Clevis Style (D)

CJ2XD Bore size – Stroke

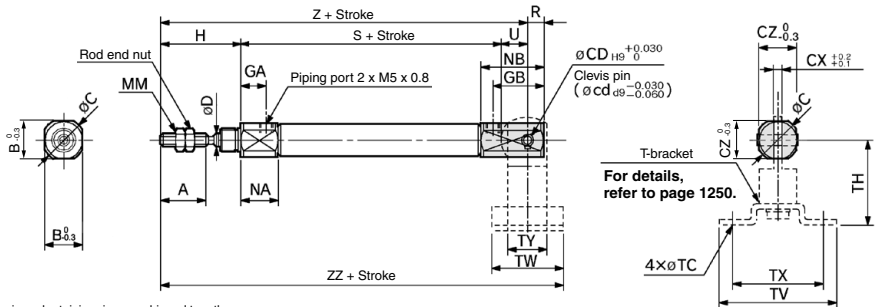

* Clevis pin and retaining ring are shipped together.

Bore size (mm)	A	B	C	CD (cd)	CX	CZ	D	GA	GB	H	MM	NA	NB	R	S	U	Z	ZZ
10	15	12	14	3.3	3.2	12	4	8	18	28	M4 x 0.7	12.5	22.5	5	46	8	82	93
16	15	18.3	20	5	6.5	18.3	5	8	23	28	M5 x 0.8	12.5	27.5	8	47	10	85	99

T-bracket Dimensions

Bore size (mm)	TC	TH	TV	TW	TX	TY
10	4.5	29	40	22	32	12
16	5.5	35	48	28	38	16

- REA
- REB
- REC
- CQY
- CQX
- MQ
- RHC
- RZQ

- D-□
- X□

Series CJ2X

Accessory Bracket Dimensions

Single Knuckle Joint (mm)

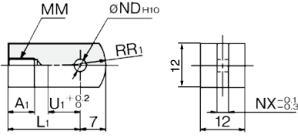

Material: Rolled steel

Part no.	Applicable bore	A ₁	L ₁	MM	ND ^{H10}	NX	R ₁	U ₁
I-J010B	10	8	21	M4 x 0.7	3.3 ^{+0.048} ₀	3.1	8	9
I-J016B	16	8	25	M5 x 0.8	5 ^{+0.048} ₀	6.4	12	14

Clevis Pin (mm)

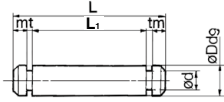

Material: Stainless steel

Part no.	Applicable bore	Dd9	d	L	L ₁	m	t	Applicable retaining ring
CD-J010	10	3.3 ^{+0.030} _{-0.060}	3	15.2	12.2	1.2	0.3	Type C 3.2
CD-Z015	16	5 ^{+0.030} _{-0.060}	4.8	22.7	18.3	1.5	0.7	Type C 5

* Retaining rings are packaged with clevis pins.

Knuckle Pin (mm)

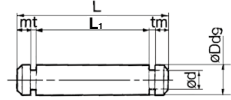

Material: Stainless steel

Part no.	Applicable bore	Dd9	d	L	L ₁	m	t	Applicable retaining ring
CD-J010	10	3.3 ^{+0.030} _{-0.060}	3	15.2	12.2	1.2	0.3	Type C 3.2
IY-J015	16	5 ^{+0.030} _{-0.060}	4.8	16.6	12.2	1.5	0.7	Type C 5

* For size ø10, clevis pin is diverted.
* Retaining rings are packaged with knuckle pins.

Double Knuckle Joint (mm)

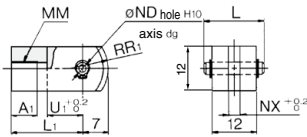

Material: Rolled steel

Part no.	Applicable bore	A ₁	L	L ₁	MM
Y-J010B	10	8	15.2	21	M4 x 0.7
Y-J016B	16	11	16.6	21	M5 x 0.8

Part no.	ND ₀₉	ND ₁₀	NX	R ₁	U ₁
Y-J010B	3.3 ^{+0.030} _{-0.060}	3.3 ^{+0.048} ₀	3.2	8	10
Y-J016B	5 ^{+0.030} _{-0.060}	5 ^{+0.048} ₀	6.5	12	10

* Knuckle pin and retaining ring are shipped together.

Mounting Nut (mm)

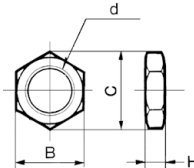

Material: Brass

Part no.	Applicable bore	B	C	d	H
SNJ-010B	10	11	12.7	M8 x 1.0	4
SNJ-016B	16	14	16.2	M10 x 1.0	4

Rod End Nut (mm)

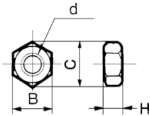

Material: Iron

Part no.	Applicable bore	B	C	d	H
NTJ-010A	10	7	8.1	M4 x 0.7	3.2
NTJ-015A	16	8	9.2	M5 x 0.8	4

T-bracket (mm)

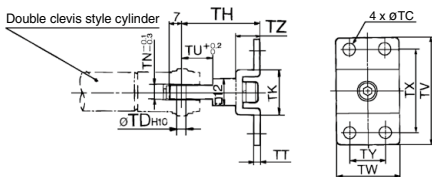

Part no.	Applicable bore	TC	TD ^{H10}	TH	TK	TN	TT	TU	TV	TW	TX	TY	TZ
CJ-T010B	10	4.5	3.3 ^{+0.048} ₀	29	18	3.1	2	9	40	22	32	12	8
CJ-T016B	16	5.5	5 ^{+0.048} ₀	35	20	6.4	2.3	14	48	28	38	16	10

* T-bracket includes a T-bracket base, single knuckle joint, hexagon socket head cap screw and spring washer.

Rod End Cap (mm)

Flat type/CJ-CF□□□ Round type/CJ-CR□□□

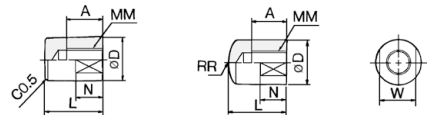

Material: Polyacetal

Part no.		Applicable bore	A	D	L	MM	N	R	W
Flat type	Round type								
CJ-CF010	CJ-CR010	10	8	10	13	M4 x 0.7	6	10	8
CJ-CF016	CJ-CR016	16	10	12	15	M5 x 0.8	7	12	10

Auto Switch Mounting 1

Auto Switch Proper Mounting Position (Detection at Stroke End) and Its Mounting Height

Reed auto switch
<Band mounting style>

D-A9□

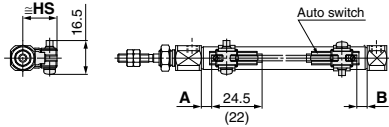

(): Values for D-A96
A and B are the dimensions from the end of the head cover/
rod cover to the end of the auto switch.

D-A9□V

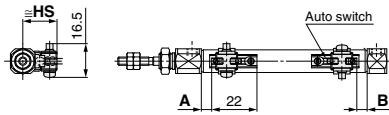

A and B are the dimensions from the end of the head cover/
rod cover to the end of the auto switch.

D-C7□/C80

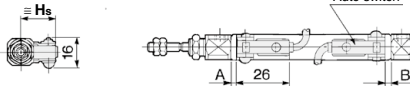

D-C73C□/C80C

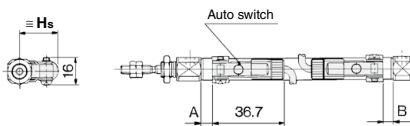

Solid state auto switch
<Band mounting style>

D-M9□

D-M9□W

D-M9□A

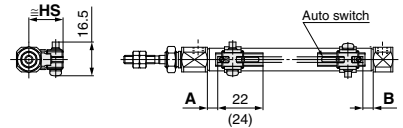

(): Values for D-M9□A
A and B are the dimensions from the end of the head cover/
rod cover to the end of the auto switch.

D-M9□V

D-M9□MV

D-M9□AV

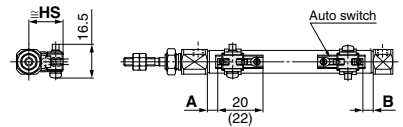

(): Values for D-M9□AV
A and B are the dimensions from the end of the head cover/
rod cover to the end of the auto switch.

D-H7□

D-H7□W

D-H7NF

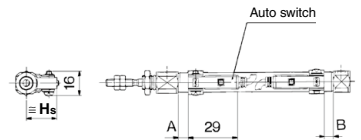

D-H7C

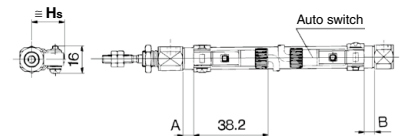

REA

REB

REC

C□Y

C□X

MQ

RHC

RZQ

D-□

-X□

Auto Switch Mounting 2

Auto Switch Proper Mounting Position (Detection at Stroke End) and Its Mounting Height

Reed auto switch
<Rail mounting style>

D-A9□

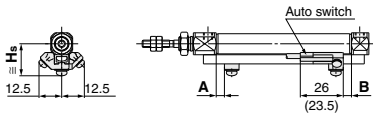

(): Values for D-A96

D-A9□V

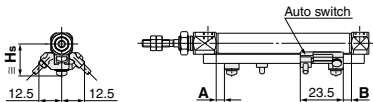

D-A7□/A80

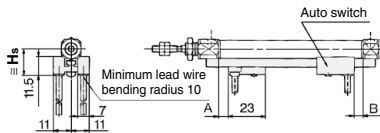

D-A7□H/A80H

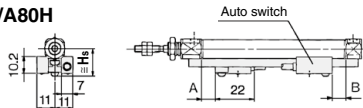

D-A73C/A80C

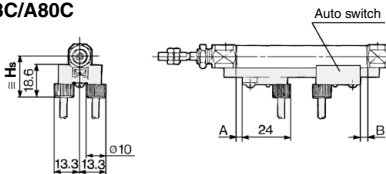

D-A79W

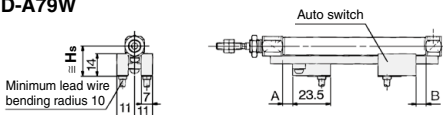

Solid state auto switch
<Rail mounting style>

D-M9□

D-M9□W

D-M9□A

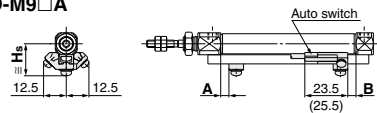

(): Values for D-M9□A

D-M9□V

D-M9□WV

D-M9□AV

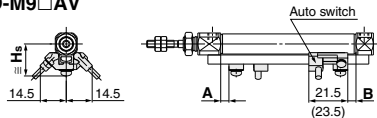

(): Values for D-M9□AV

D-F7□/J79

D-F7□W/J79W

D-F79F

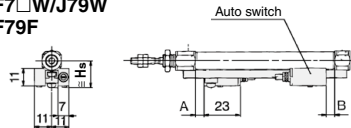

D-F7□V/F7□WV

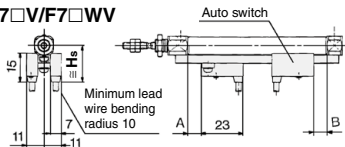

D-J79C

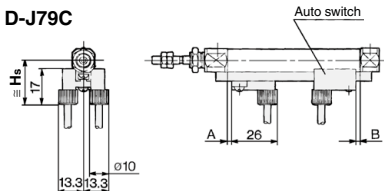

Auto Switch Proper Mounting Position (Detection at Stroke End) and Its Mounting Height

Auto Switch Proper Mounting Position

Auto switch model		Band mounting										Rail mounting									
		D-A9□ D-A9□V		D-M9□ D-M9□V D-M9□W D-M9□WV D-M9□A D-M9□AV		D-C7□ D-C80 D-C73C D-C80C		D-H7□ D-H7C D-H7NF D-H7□W		D-A9□ D-A9□V		D-M9□ D-M9□V D-M9□W D-M9□WV D-M9□A D-M9□AV		D-A7□ D-A80		D-A7□H/A80H D-A73C/A80C D-F7□J79 D-F7□W/J79W D-F7□V/F7□WV D-F79F D-J79C		D-F7NT		D-A79W	
Bore size (mm)		A	B	A	B	A	B	A	B	A	B	A	B	A	B	A	B	A	B	A	B
		10		2	2	6	6	2.5	2.5	1.5	1.5	0.5	0.5	4.5	4.5	3	3	3.5	3.5	8.5	8.5
16		2.5	2.5	6.5	6.5	3	3	2	2	1	1	5	5	3.5	3.5	4	4	9	9	1	1

Note) Adjust the auto switch after confirming the operating conditions in the actual setting.

Auto Switch Mounting Height

Auto switch model		Band mounting					Rail mounting						
		D-A9□ D-M9□ D-M9□W D-M9□A	D-M9□V D-M9□WV D-M9□AV D-A9□V	D-C7□ D-C80 D-H7□ D-H7□W D-H7NF	D-C73C D-C80C	D-H7C	D-A7□ D-A80	D-A9□ D-A9□V D-M9□ D-M9□V D-M9□W D-M9□WV	D-A7□H/A80H D-F7□J79 D-F7□W/J79W D-F79F D-F7NT	D-A73C D-A80C	D-F7□V D-F7□WV	D-J79C	D-A79W
Bore size (mm)		Hs	Hs	Hs	Hs	Hs	Hs	Hs	Hs	Hs	Hs	Hs	
		10		17	18	17	19.5	20	16.5	17.5	17.5	23.5	20
16		20.5	21	20.5	23	23.5	19.5	21	20.5	26.5	23	26	22

- REA
- REB
- REC
- C□Y
- C□X**
- MQ
- RHC
- RZQ

- D-□
- X□

Auto Switch Mounting 3

Minimum Auto Switch Mounting Stroke

		(mm)				
Auto switch mounting	Auto switch model	No. of auto switch mounted				
		1 pc.	2 pcs.		n pcs. (n: No. of auto switch)	
			Different surfaces	Same surface	Different surfaces	Same surface
Band mounting	D-M9□/M9□W D-M9□A/A9□	10	15 <small>Note 1)</small>	45 <small>Note 1)</small>	$15 + 35 \frac{(n-2)}{2}$ <small>Note 4)</small> (n = 2, 4, 6...)	45 + 15 (n-2) (n = 2, 3, 4, 5...)
	D-M9□V	5	15 <small>Note 1)</small>	35	$15 + 35 \frac{(n-2)}{2}$ <small>Note 4)</small> (n = 2, 4, 6...)	35 + 25 (n-2) (n = 2, 3, 4, 5...)
	D-M9□WV D-M9□AV	10	15 <small>Note 1)</small>	35	$15 + 35 \frac{(n-2)}{2}$ <small>Note 4)</small> (n = 2, 4, 6...)	35 + 25 (n-2) (n = 2, 3, 4, 5...)
	D-A9□V	5	10	35	$10 + 35 \frac{(n-2)}{2}$ <small>Note 4)</small> (n = 2, 4, 6...)	35 + 25 (n-2) (n = 2, 3, 4, 5...)
	D-C7□ D-C80	10	15	50	$15 + 40 \frac{(n-2)}{2}$ <small>Note 4)</small> (n = 2, 4, 6...)	50 + 20 (n-2) (n = 2, 3, 4, 5...)
	D-H7□/H7□W D-H7NF	10	15	60	$15 + 45 \frac{(n-2)}{2}$ <small>Note 4)</small> (n = 2, 4, 6...)	60 + 22.5 (n-2) (n = 2, 3, 4, 5...)
	D-C73C D-C80C D-H7C	10	15	65	$15 + 50 \frac{(n-2)}{2}$ <small>Note 4)</small> (n = 2, 4, 6...)	50 + 27.5 (n-2) (n = 2, 3, 4, 5...)
	Rail mounting	D-M9□V	5	—	5	—
D-A9□V		5	—	10	—	10 + 15 (n-2) (n = 4, 6...) <small>Note 5)</small>
D-M9□ D-A9□		10 (5)	—	10	—	15 + 15 (n-2) (n = 4, 6...) <small>Note 5)</small>
D-M9□WV D-M9□AV		10	—	15	—	15 + 15 (n-2) (n = 4, 6...) <small>Note 5)</small>
D-M9□W D-M9□A		15 (10)	—	15	—	20 + 15 (n-2) (n = 4, 6...) <small>Note 5)</small>
D-A7□/A80 D-A7□H/A80H D-A73C/A80C		5	—	10	—	15 + 10 (n-2) (n = 4, 6...) <small>Note 5)</small>
D-A7□H D-A80H		5	—	10	—	15 + 15 (n-2) (n = 4, 6...) <small>Note 5)</small>
D-A79W		10	—	15	—	10 + 15 (n-2) (n = 4, 6...) <small>Note 5)</small>
D-F7□ D-J79		5	—	5	—	15 + 15 (n-2) (n = 4, 6...) <small>Note 5)</small>
D-F7□V D-J79C		5	—	5	—	10 + 10 (n-2) (n = 4, 6...) <small>Note 5)</small>
D-F7□W/J79W D-F79F D-F7NT		10	—	15	—	15 + 20 (n-2) (n = 4, 6...) <small>Note 5)</small>
D-F7□WV		10	—	15	—	10 + 15 (n-2) (n = 4, 6...) <small>Note 5)</small>

Note 4) When "n" is an odd number, an even number that is one larger than this odd number is used for the calculation.
 Note 5) When "n" is an odd number, an even number that is one larger than this odd number is used for the calculation.
 However, the minimum even number is 4. So, 4 is used for the calculation when "n" is 1 to 3.

Note 1) Auto switch mounting

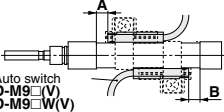
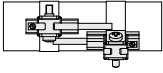
Auto switch model	With 2 auto switches	
	Different surfaces <small>Note 1)</small>	Same surface <small>Note 1)</small>
 <p>Auto switch D-M9□(V) D-M9□W(V) D-M9□A(V)</p> <p>The proper auto switch mounting position is 5.5 mm inward from the switch holder edge. The above A and B indicate values for band mounting in the table of page 1253.</p>	 <p>The auto switch is mounted by slightly displacing it in a direction (cylinder tube circumferential exterior) so that the auto switch and lead wire do not interfere with each other.</p>	
D-M9□/M9□W/M9□A	Less than 20 stroke <small>Note 2)</small>	Less than 55 stroke <small>Note 2)</small>
D-A90/A93	—	Less than 50 stroke <small>Note 2)</small>

Note 2) Minimum stroke for auto switch mounting in styles other than those in Note 1.

Note 3) The dimensions stated in () shows the minimum stroke for the auto switch mounting when the auto switch does not project from the end surface of the cylinder body and hinder the lead wire bending space. (Refer to the figure below.)

These contents apply to the rail mounting with one or two auto switches.

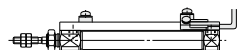

Operating Range

		(mm)	
		Bore size (mm)	
Auto switch model		10	16
Band mounting	D-A9□/A9□V	6	7
	D-M9□/M9□V	2.5	3
	D-M9□W/M9□WV		
	D-M9□A/M9□AV		
	D-C7□/C80/C73C/C80C	7	7
D-H7□/H7□W	4	4	
D-H7NF			
D-H7C	8	9	
Rail mounting	D-A9□/A9□V	6	6.5
	D-M9□/M9□V	3	3.5
	D-M9□W/M9□WV		
	D-M9□A/M9□AV		
	D-A7□/A80/A7H/A80H	8	9
	D-A73C/A80C		
	D-A79W	11	13
	D-F7□/J79/F7□W/J79W	5	5
D-F7□V/F7□WV/F79F			
D-J79C			
D-F7NT			

* Since this is a guideline including hysteresis, not meant to be guaranteed.
 (Assuming approximately ±30% dispersion.)
 There may be the case it will vary substantially depending on an ambient environment.

Auto Switch Mounting Bracket/Part No.

Auto switch mounting	Auto switch model	Bore size	
		φ10	φ16
Band mounting	D-A9□ D-M9□ D-M9□W	Note 1), Note 2) ① BJ2-010 ② BJ3-1	Note 1), Note 2) ① BJ2-016 ② BJ3-1
Rail mounting	D-C7□/C80 D-C73C/C80C D-H7□/H7□W D-H7NF	BJ2-010	BJ2-016
Rail mounting	D-A9□ D-A9□V D-M9□ D-M9□V D-M9□W D-M9□WV D-M9□A D-M9□AV	Note 3) BQ2-012	Note 3) BQ2-012

Note 1) Two kinds of auto switch mounting brackets are used as a set.

Note 2) Auto switch mounting brackets are shipped together with cylinders.

Note 3) When mounting a compact auto switch on the φ10 or φ16 rail mounting type, order auto switch mounting bracket shown in the table above. Order it separately from the cylinder.

Example
 CDJ2BX10-60-A 1 unit
 D-M9BWV 2 pcs.
 BQ2-012 2 pcs.

Note 4) For the D-M9□A (V) type auto switch, do not install the switch bracket on the indicator light.

Other than the applicable auto switches listed in "How to Order", the following auto switches can be mounted. For detailed specifications, refer to pages 1893 to 2007.

Auto switch type	Model	Electrical entry (Direction)	Features
Reed	D-C73, C76	Grommet (in-line)	—
	D-C80		Without indicator light
Solid state	D-H7A1, H7A2, H7B		—
	D-H7NW, H7PW, H7BW		Diagnostic indication (2-color indication)

* With pre-wired connector is available for solid state auto switches. For details, refer to pages 1960 to 1961.

* Normally closed (NC = b contact), solid state auto switches (D-F9G, F9H type) are also available. For details, refer to page 1911.

REA

REB

REC

C□Y

C□X

MQ

RHC

RZQ

D-□

-X□

Low Speed Cylinder Double Acting, Single Rod Series **CUX** ø10, ø16, ø20, ø25, ø32

How to Order

CUX 10 - 30 D

With auto switch CDUX 10 - 30 D - M9BW

With auto switch (Built-in magnet)

Low speed cylinder

Bore size

10	10 mm
16	16 mm
20	20 mm
25	25 mm
32	32 mm

Port thread type

Symbol	Type	Bore size
Nil	M5 x 0.8	ø10, ø16, ø20, ø25
	Rc 1/8	ø32
TN	NPT 1/8	ø32
TF	G 1/8	ø32

Standard stroke (mm)

10, 16	5, 10, 15, 20, 25, 30
20, 25, 32	5, 10, 15, 20, 25, 30, 40, 50

Auto switch

Nil	Without auto switch
S	1 pc.
	2 pcs.

* For the applicable auto switch model, refer to the table below.

Action

D	Double acting
---	---------------

Number of auto switches

Nil	2 pcs.
S	1 pc.

Built-in Magnet Cylinder Model

If a built-in magnet cylinder without an auto switch is required, there is no need to enter the symbol for the auto switch.
(Example) CDUX20-25D

Applicable Auto Switches

Refer to pages 1893 to 2007 for further information on auto switches.

Type	Special function	Electrical entry	Indicate light	Wiring (Output)	Load voltage		Auto switch model		Lead wire length (m)			Pre-wired connector	Applicable load	
					DC	AC	Perpendicular	In-line	0.5 (Nil)	1 (M)	3 (L)			5 (Z)
Solid state auto switch	—	Grommet	Yes	3-wire (NPN)	24 V	5 V, 12 V	M9NV	M9N	●	●	○	○	IC circuit	Relay, PLC
				3-wire (PNP)			M9PV	M9P	●	●	○	○		
				2-wire			M9BV	M9B	●	●	○	○		
				3-wire (NPN)			M9NWW	M9NW	●	●	○	○		
	Diagnostic indication (2-color indication)			3-wire (PNP)	M9PWW	M9PW	●	●	○	○	—			
				2-wire	M9BWW	M9BW	●	●	○	○	—			
				3-wire (NPN)	M9NAV**	M9NA**	○	○	●	○	IC circuit			
				3-wire (PNP)	M9PAV**	M9PA**	○	○	●	○	—			
Water resistant (2-color indication)	2-wire	M9BAV**	M9BA**	○	○	●	○	—						
	3-wire (NPN equivalent)	—	5 V	A96V	A96	●	—	—	—	IC circuit	—			
				A93V	A93	●	—	—	—	—	Relay, PLC			
	2-wire	24 V	12 V	100 V or less	A90V	A90	●	—	—	—	IC circuit	—		

** Water resistant type auto switches can be mounted on the above models, but in such case SMC cannot guarantee water resistance.

Consult with SMC regarding water resistant types with the above model numbers.

* Lead wire length symbols: 0.5 m Nil (Example) M9NV
1 m M (Example) M9NWW
3 m L (Example) M9NWL
5 m Z (Example) M9NWL

* Solid state auto switches marked with "○" are produced upon receipt of order.

* Since there are other applicable auto switches than listed, refer to page 1260 for details.

* For details about auto switches with pre-wired connector, refer to pages 1960 and 1961.

* Auto switches are shipped together (not assembled).

Specifications



Bore size (mm)	10	16	20	25	32
Fluid	Air				
Proof pressure	1.05 MPa				
Maximum operating pressure	0.7 MPa				
Ambient and fluid temperature	Without auto switch: -10 to 70°C (No freezing) With auto switch: -10 to 60°C (No freezing)				
Lubrication	Not required (Non-lube)				
Piston speed	ø10, ø16: 1 to 300 mm/s ø20 to ø32: 0.5 to 300 mm/s				
Cushion	Rubber bumper on both ends				
Rod end thread	Male thread				
Stroke length tolerance	+1.0 (Note) 0				
Mounting	Basic style				

Note) Tolerance ± 1.0

Symbol

Double acting, Single rod/Rubber bumper

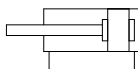

Minimum Operating Pressure

Bore size (mm)	10	16	20	25	32
Min. operating pressure (MPa)	0.06	0.06	0.05	0.05	0.05

Standard Stroke

Bore size (mm)	Standard stroke (mm)
10, 16	5, 10, 15, 20, 25, 30
20, 25, 32	5, 10, 15, 20, 25, 30, 40, 50

⚠ Precautions

Be sure to read before handling.

Refer to front matter 39 for Safety Instructions and pages 3 to 12 for Actuator and Auto Switch Precautions.

Mounting

⚠ Caution

- Tightening the cylinder beyond the range of the indicated torque (shown in the table below) may affect operation. Apply Loctite® (no. 242, Blue) to the mounting threads.

Bore size (mm)	Hexagon socket head (mm)	Proper tightening torque (N·m) (Cylinder body)
10	M3	0.54 ±10%
16	M4	1.23 ±10%
20, 25	M5	2.55 ±10%
32	M6	4.02 ±10%

Operating Precautions

⚠ Warning

- It might not be able to control CUX10 by meter-out at a low speed operation.

⚠ Caution

- For CUX10, up to 0.1 N L/min (ANR) of internal leakage is anticipated due to cylinder structure.

Maintenance

⚠ Caution

1. Replacement parts/Seal kit

Order it in accordance with the bore size.

Bore size (mm)	Kit no.	Contents
16	CUX16-PS	Piston seal: 1 pc.
20	CUX20-PS	Rod seal: 1 pc.
25	CUX25-PS	Gasket: 1 pc.
32	CUX32-PS	Grease pack (10 g): 1 pc.

* It is impossible to replace seals in bore size 10 mm.

2. Grease pack

When maintenance requires only grease, use the following part numbers to order.

Grease pack part no.:

GR-L-005 (5 g)
GR-L-010 (10 g)
GR-L-150 (150 g)

REA

REB

REC

COY

CUX

MQ

RHC

RZQ

D-□

-X□

Series CUX

Dimensions: Double Acting, Single Rod

ø10

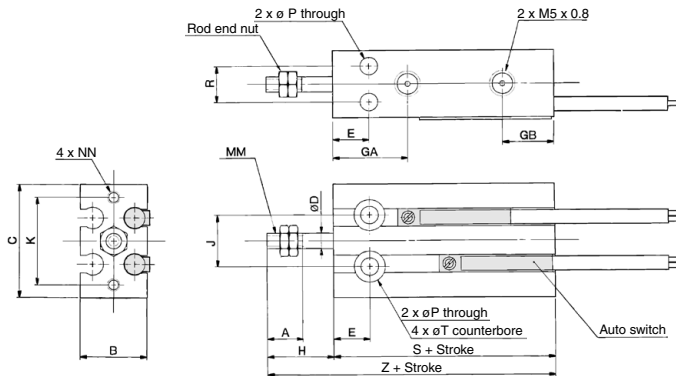

ø16 to ø32

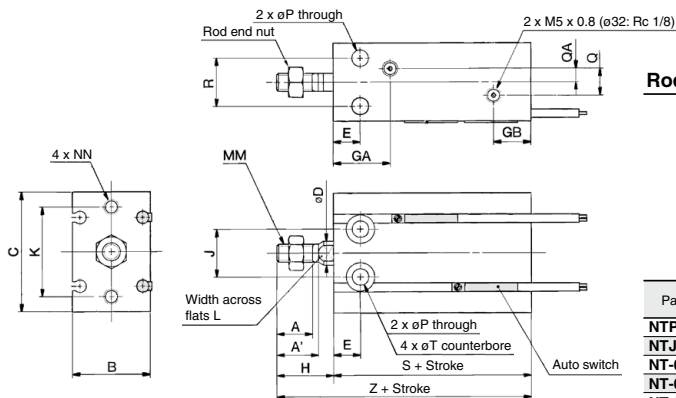

Rod End Nut/Accessory

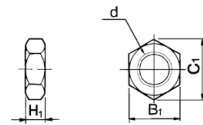

Material: Carbon steel

Part no.	Applicable bore (mm)	d	H ₁	B ₁	C ₁
NTP-010	10	M4 x 0.7	2.4	7	8.1
NTJ-015A	16	M5 x 0.8	4	8	9.2
NT-015A	20	M6 x 1.0	5	10	11.5
NT-02	25	M8 x 1.25	5	13	15.0
NT-03	32	M10 x 1.25	6	17	19.6

Bore size (mm)	(mm)																
	A	A'	B	C	D	E	GA	GB	H	J	K	L	MM	NN	P	Q	QA
10	10	—	15	24	4	7	16.5	10	16	11	18	—	M4 x 0.7	M3 x 0.5 depth 5	3.2	—	—
16	11	12.5	20	32	6	7	16.5 ^(Note)	11.5	16	14	25	5	M5 x 0.8	M4 x 0.7 depth 6	4.5	4	2
20	12	14	26	40	8	9	19	12.5	19	16	30	6	M6 x 1.0	M5 x 0.8 depth 8	5.5	9	4.5
25	15.5	18	32	50	10	10	21.5	13	23	20	38	8	M8 x 1.25	M5 x 0.8 depth 8	5.5	9	4.5
32	19.5	22	40	62	12	11	23	12.5	27	24	48	10	M10 x 1.25	M6 x 1.0 depth 9	6.6	13.5	4.5

Bore size (mm)	R	T	Without auto switch		With auto switch	
			S	Z	S	Z
10	9	6 depth 5	36	52	36	52
16	12	7.6 depth 6.5	30	46	40	56
20	16	9.3 depth 8	36	55	46	65
25	20	9.3 depth 9	40	63	50	73
32	24	11 depth 11.5	42	69	52	79

Note) 5 stroke (CUX16-5D): 14.5 mm

Auto Switch Mounting 1

Auto Switch Proper Mounting Position (Detection at Stroke End) and Its Mounting Height

- D-A9□
- D-M9□
- D-M9□W
- D-M9□A

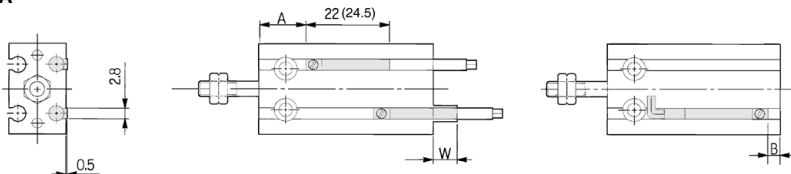

() : Denotes the values of D-A93.

- D-A9□V
- D-M9□V
- D-M9□WV
- D-M9□AV

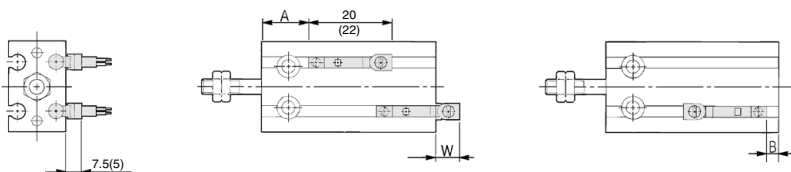

() : Denotes the values of D-A9□V.

CDU Double Acting, Single Rod

Bore size (mm)	D-A9□, D-A9□V			D-M9□, D-M9□W			D-M9□V, D-M9□WV			D-M9□A			D-M9□AV		
	A	B	W	A	B	W	A	B	W	A	B	W	A	B	W
10	12.5	3.5	(-1.5)1	16.5	7.5	2.5	16.5	7.5	0.5	16.5	7.5	4.5	16.5	7.5	2.5
16	16	4	(-2)0.5	20	8	1.5	20	8	-0.5	20	8	3.5	20	8	1.5
20	20	6	(-4)-1.5	24	10	0	24	10	-2	24	10	2	24	10	0
25	22.5	7	(-5.5)-3	26.5	11	-1.5	26.5	11	-3.5	26.5	11	0.5	26.5	11	-1.5
32	23.5	8.5	(-6.5)-4	27.5	12.5	-2.5	27.5	12.5	-4.5	27.5	12.5	-0.5	27.5	12.5	-2.5

Note 1) Figures in the table above are used as a reference when mounting the auto switches for stroke end detection. In the case of actually setting the auto switches, adjust them after confirming their operation.

Note 2) Negative figures in the table W indicate an auto switch is mounted inward from the edge of the cylinder body.

Note 3) In the case of the 5 stroke or the 10 stroke, there are times in which the auto switch will not turn OFF or 2 auto switches will turn ON simultaneously due to their movement range. Therefore, set the position approximately 1 to 4 mm outward from the values given in the table above. Then, perform an operation inspection to make sure that the auto switches operate normally (if 1 auto switch is used, make sure that it turns ON and OFF properly; if 2 auto switches are used, make sure that both auto switches turn ON).

Note 4) () in column W is the dimensions of D-A96.

Operating Range

Auto switch model	Bore size (mm)				
	10	16	20	25	32
D-A9□, A9□V	6	9	11	12.5	14
D-M9□, M9□V D-M9□W, M9□WV D-M9□A, M9□AV	4	5.5	7	7	7.5

* Since this is a guideline including hysteresis, not meant to be guaranteed. (assuming approximately ±30% dispersion.)

There may be the case it will vary substantially depending on an ambient environment.

REA

REB

REC

C□Y

C□X

MQ

RHC

RZQ

D-□

-X□

Series CUX

Auto Switch Mounting 2

Other than the applicable auto switches listed in “How to Order”, the following auto switches can be mounted.

* Normally closed (NC = b contact), solid state auto switches (D-F9G, F9H type) are also available. For details, refer to page 1911.

Caution on Proximity Installation

When free mounting cylinders equipped with auto switches are used, the auto switches could activate unintentionally if the installed distance is less than the dimensions shown in the table. Therefore, make sure to provide a greater clearance. Due to unavoidable circumstances, if they must be used with less distance than the dimensions given in the table, the cylinders must be shielded. Therefore, affix a steel plate or a magnetic shielding plate (MU-S025) to the area on the cylinder that corresponds to the adjacent auto switch. (Please contact SMC for details.) Auto switches may malfunction if a shield plate is not used.

Dimensions of shielding plate (MU-S025) that is sold separately are indicated as reference.

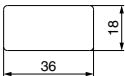

Material: Ferrite stainless steel, Thickness: 0.3 mm

Since the back side is treated with adhesive, it is possible to attach to the cylinder.

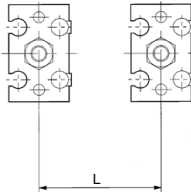

Bore size (mm)	Mounting pitch L (mm)
10	30
16	33
20	40
25	46
32	56

Low Speed Cylinder Double Acting, Single Rod Series **CQSX** ø12, ø16, ø20, ø25

How to Order

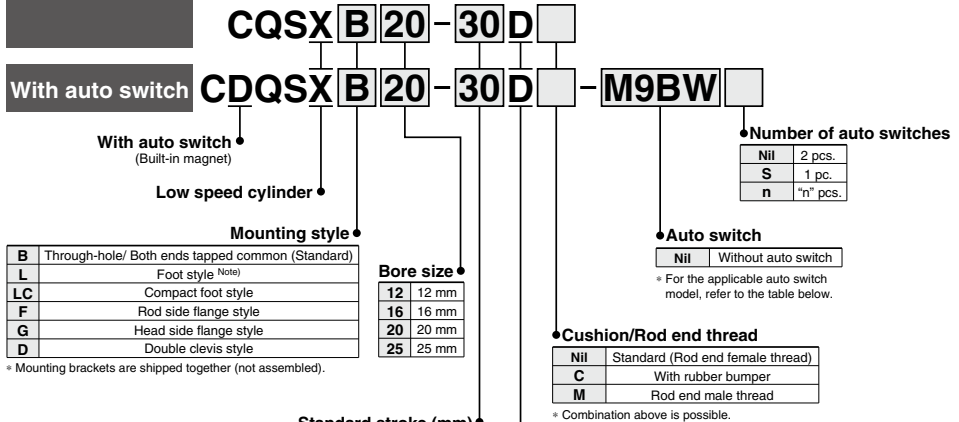

* Mounting brackets are shipped together (not assembled).

* For the applicable auto switch model, refer to the table below.

* Combination above is possible.

Bore size	Standard stroke
12, 16	5, 10, 15, 20, 25, 30
20, 25	5, 10, 15, 20, 25, 30, 35, 40, 45, 50

• Manufacturing of intermediate stroke
Intermediate strokes by the 1 mm interval are available by using spacers with standard stroke cylinders. The overall length of cylinder will be the same as the standard stroke with a longer one.
Example) 3 mm width spacer is installed in the standard cylinder CQSXB25-50D to make CQSXB25-47D.

Applicable Auto Switches

Refer to pages 1893 to 2007 for further information on auto switches.

Type	Special function	Electrical entry	Indicate light	Wiring (Output)	Load voltage		Auto switch model		Lead wire length (m)			Pre-wired connector	Applicable load	
					DC	AC	Perpendicular	In-line	0.5 (Nil)	1 (M)	3 (L)			5 (Z)
Solid state auto switch	—	Grommet	Yes	3-wire (NPN)	24 V	—	M9NV	M9N	●	●	○	○	IC circuit	
				3-wire (PNP)			M9PV	M9P	●	●	○	○		
				2-wire			M9BV	M9B	●	●	○	○		—
				3-wire (NPN)			M9NVW	M9NW	●	●	○	○		IC circuit
	3-wire (PNP)			M9PVW	M9PW	●	●	○	○					
	Diagnostic indication (2-color indication)			Water resistant (2-color indication)	2-wire	—	M9BW	M9B	●	●	○	○	—	Relay, PLC
					3-wire (NPN)		M9NAV***	M9NA***	○	○	○	○	IC circuit	
					3-wire (PNP)		M9PAV***	M9PA***	○	○	●	○		
2-wire		M9BAV***	M9BA***		○		○	●	○	—				
Magnetic field resistant (2-color indication)	—	2-wire (Non-polar)	—	—	P3DW**	●	—	●	○	—	—			
		3-wire (NPN equivalent)		—	A96V	A96	●	—	●	—		—	IC circuit	
				—	100 V	A93V	A93	●	—	●		—		Relay, PLC
				24 V	100 V or less	A90V	A90	●	—	●		—		
Reed auto switch	—	Grommet	Yes	2-wire	24 V	12 V	—	—	—	—	—	—	—	
														No

*** Water resistant type auto switches can be mounted on the above models, but in such case SMC cannot guarantee water resistance. Consult with SMC regarding water resistant types with the above model numbers.

* Lead wire length symbols: 0.5 m Nil (Example) M9NW
1 m M (Example) M9NWM
3 m L (Example) M9NLW
5 m Z (Example) M9NZL

* Solid state auto switches marked with "O" are produced upon receipt of order.
** D-P3DW□ is compatible with ø25. It is mounted away from the port side to avoid interference with fittings.

* Since there are other applicable auto switches than listed, refer to page 1267 for details.
* For details about auto switches with pre-wired connector, refer to pages 1960 and 1961. For D-P3DW□, refer to pages 1948 and 1949.
* Auto switches are shipped together (not assembled).
Note) D-A9□V/M9□V/M9□V/M9□V/M9□V auto switches may not be mounted depending on the cylinder stroke or fitting size for piping. Consult with SMC separately.

REA
REB
REC
C□Y
C□X
MQ
RHC
RZQ

D-□
-X□

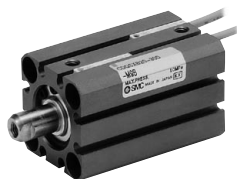

Specifications

Bore size (mm)	12	16	20	25
Type	Pneumatic (Non-lube)			
Action	Double acting, Single rod			
Fluid	Air			
Proof pressure	1.5 MPa			
Maximum operating pressure	1.0 MPa			
Ambient and fluid temperature	Without auto switch: -10 to 70°C (No freezing) With auto switch: -10 to 60°C (No freezing)			
Cushion	None, Rubber bumper			
Rod end thread	Female thread			
Stroke length tolerance	+1.0 (Note)			
Piston speed	ø12, ø16: 1 to 300 mm/s ø20, ø25: 0.5 to 300 mm/s			

Note) Stroke length tolerance does not include the amount of bumper change.

Minimum Operating Pressure

Bore size (mm)	12	16	20	25
Min. operating pressure (MPa)	0.03	0.03	0.025	0.025

Symbol

Single rod/Without cushion

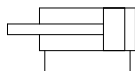

Single rod/Rubber bumper

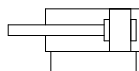

⚠ Precautions

Be sure to read before handling.

Refer to front matter 39 for Safety Instructions and pages 3 to 12 for Actuator and Auto Switch Precautions.

Retaining Ring Installation/Removal

⚠ Caution

- For installation and removal, use an appropriate pair of pliers (tool for installing a type C retaining ring).
- Even if a proper plier (tool for installing type C retaining ring) is used, it is likely to inflict damage to a human body or peripheral equipment, as a retaining ring may be flown out of the tip of a plier (tool for installing a type C retaining ring). Be much careful with the popping of a retaining ring. Besides, be certain that a retaining ring is placed firmly into the groove of rod cover before supplying air at the time of installment.

Maintenance

⚠ Caution

1. Replacement parts/Seal kit

Order it in accordance with the bore size.

Bore size (mm)	Kit no.	Contents
12	CQSX12-PS	Piston seal: 1 pc.
16	CQSX16-PS	Rod seal: 1 pc.
20	CQSX20-PS	Tube gasket: 1 pc.
25	CQSX25-PS	Grease pack (10 g): 1 pc.

2. Grease pack

When maintenance requires only grease, use the following part numbers to order.

Grease pack part no.:

GR-L-005 (5 g)

GR-L-010 (10 g)

GR-L-150 (150 g)

Mounting Bracket Part No.

Bore size (mm)	Foot ⁽¹⁾	Compact foot	Flange	Double clevis
12	CQS-L012	CQS-LC012	CQS-F012	CQS-D012
16	CQS-L016	CQS-LC016	CQS-F016	CQS-D016
20	CQS-L020	CQS-LC020	CQS-F020	CQS-D020
25	CQS-L025	CQS-LC025	CQS-F025	CQS-D025

Note 1) When ordering foot bracket, order 2 pieces per cylinder.

Note 2) Parts belonging to each bracket are as follows.

Foot, Compact foot, Flange: Body mounting bolts

Double clevis: Clevis pin, Type C retaining ring for shaft, Body mounting bolts

Mounting Bolt for CQSX/Without Auto Switch

Mounting method: Mounting bolt for through-hole mounting style of CQSXB is available as an option.

Refer to the following for ordering procedures. Order the actual number of bolts that will be used.

Example) CQ-M3x25 L 4 pcs.

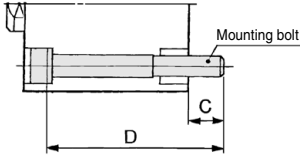

Note) The appropriate plain washer must be used for through-hole mounting.

Cylinder model	C	D	Mounting bolt part no.
CQSXB12-5D		25	CQ-M3 x 25 L
10D	6.5	30	x 30 L
15D		35	x 35 L
20D		40	x 40 L
25D		45	x 45 L
30D		50	x 50 L
CQSXB16-5D		25	CQ-M3 x 25 L
10D	6.5	30	x 30 L
15D		35	x 35 L
20D		40	x 40 L
25D		45	x 45 L
30D		50	x 50 L
CQSXB20-5D		25	CQ-M5 x 25 L
10D	6.5	30	x 30 L
15D		35	x 35 L
20D		40	x 40 L
25D		45	x 45 L
30D		50	x 50 L

Cylinder model	C	D	Mounting bolt part no.
CQSXB20-30D		50	CQ-M5 x 50 L
35D	6.5	55	x 55 L
40D		60	x 60 L
45D		65	x 65 L
50D		70	x 70 L
CQSXB25-5D		8.5	30
10D	35		x 35 L
15D	40		x 40 L
20D	45		x 45 L
25D	50		x 50 L
30D	55		x 55 L
35D	60		x 60 L
40D	65		x 65 L
45D	70		x 70 L
50D	75		x 75 L

Material: Chromium molybdenum steel
Surface material: Zinc chromated

Mounting Bolt for CDQSX/With Auto Switch

Mounting method: Mounting bolt for through-hole mounting style of CDQSXB is available as an option.

Refer to the following for ordering procedures. Order the actual number of bolts that will be used.

Example) CQ-M3x30 L 4 pcs.

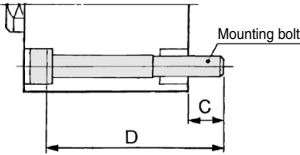

Note) The appropriate plain washer must be used for through-hole mounting.

Cylinder model	C	D	Mounting bolt part no.
CDQSXB12-5D		30	CQ-M3 x 30 L
10D	6.5	35	x 35 L
15D		40	x 40 L
20D		45	x 45 L
25D		50	x 50 L
30D		55	x 55 L
CDQSXB16-5D		30	CQ-M3 x 30 L
10D	6.5	35	x 35 L
15D		40	x 40 L
20D		45	x 45 L
25D		50	x 50 L
30D		55	x 55 L
CDQSXB20-5D		35	CQ-M5 x 35 L
10D	6.5	40	x 40 L
15D		45	x 45 L
20D		50	x 50 L
25D		55	x 55 L
30D		60	x 60 L

Cylinder model	C	D	Mounting bolt part no.
CDQSXB20-30D		60	CQ-M5 x 60 L
35D	6.5	65	x 65 L
40D		70	x 70 L
45D		75	x 75 L
50D		80	x 80 L
CDQSXB25-5D		8.5	40
10D	45		x 45 L
15D	50		x 50 L
20D	55		x 55 L
25D	60		x 60 L
30D	65		x 65 L
35D	70		x 70 L
40D	75		x 75 L
45D	80		x 80 L
50D	85		x 85 L

Material: Chromium molybdenum steel
Surface material: Zinc chromated

Accessory

For accessory bracket for Series CQS, refer to page 1274, since it is commonly used with Series CQ2.

- Single knuckle joint
- Pin for knuckle
- Double knuckle joint
- Rod end nut

REA

REB

REC

CQY

CQX

MQ

RHC

RZQ

D-□

-X□

Series CQSX

Dimensions: $\phi 12$ to $\phi 25$

* For the auto switch mounting position and its mounting height, refer to page 1266.

Basic style (Through-hole/Both ends tapped common): CQSXB/CDQSXB

$\phi 12$

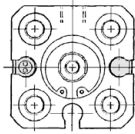

$\phi 16$ 2 x 4 x ϕ OB counterbore depth RB

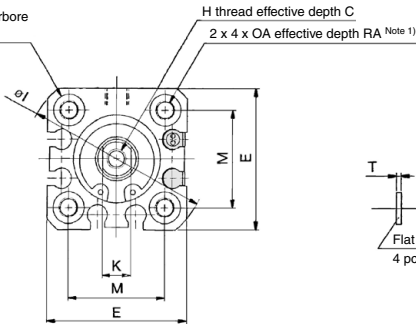

$\phi 20, \phi 25$

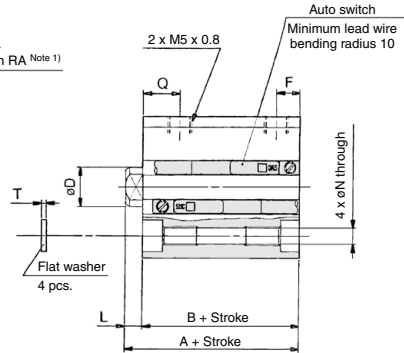
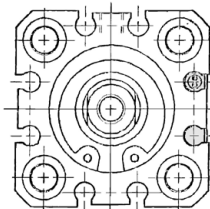

Rod end male thread

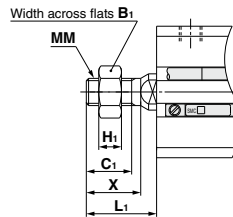

Rod End Male Thread

(mm)

Bore size (mm)	B ₁	C ₁	H ₁	L ₁	MM	X
12	8	9	4	14	M5 x 0.8	10.5
16	10	10	5	15.5	M6 x 1.0	12
20	13	12	5	18.5	M8 x 1.25	14
25	17	15	6	22.5	M10 x 1.25	17.5

- Length with intermediate stroke
Spacer ... The dimensions will be identical to those of the nearest long stroke.

Basic Style

(mm)

Bore size (mm)	Standard stroke (mm)	Without auto switch		With auto switch		C	D	E	F	H	I	K	L	M	N	OA	OB	Q	RA	RB	T
		A	B	A	B																
12	5 to 30	20.5	17	25.5	22	6	6	25	5	M3 x 0.5	32	5	3.5	15.5	3.5	M4 x 0.7	6.5	7.5	7	4	0.5
16	5 to 30	20.5	17	25.5	22	8	8	29	5	M4 x 0.7	38	6	3.5	20	3.5	M4 x 0.7	6.5	7.5	7	4	0.5
20	5 to 50	24	19.5	34	29.5	7	10	36	5.5	M5 x 0.8	47	8	4.5	25.5	5.4	M6 x 1.0	9	9	10	7	1
25	5 to 50	27.5	22.5	37.5	32.5	12	12	40	5.5	M6 x 1.0	52	10	5	28	5.4	M6 x 1.0	9	11	10	7	1

Note 1) For the following bore/stroke sizes through-hole is threaded over the entire length: Basic style $\phi 12$ and $\phi 16$; 5 stroke, $\phi 20$; 5 to 15 stroke, $\phi 25$; 5 to 10 stroke, $\phi 20$ with auto switch built-in magnet; 5 stroke.

Note 2) Rubber bumper type has the same dimensions as those indicated above.

* For details about the rod end nut and accessory brackets, refer to page 1274.

Foot style: CQSXL/CDQSXL

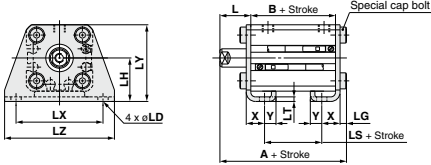

Rod end male thread

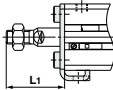

Compact foot style: CQSXLC/CDQSXLC

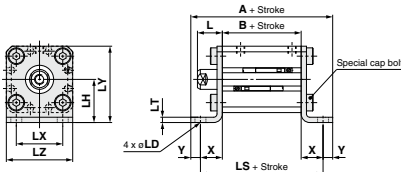

Rod end male thread

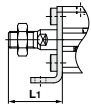

Rod side flange style: CQSXF/CDQSXF

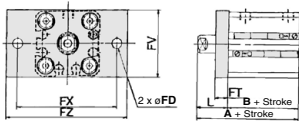

Rod end male thread

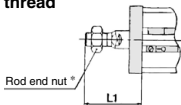

Head side flange style: CQSXG/CDQSXG

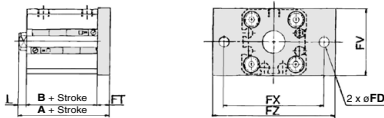

Rod end male thread

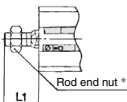

Foot Style

Bore size (mm)	Standard stroke (mm)	Without auto switch			With auto switch			L	L1
		A	B	LS	A	B	LS		
12	5 to 30	35.3	17	5	40.3	22	10	13.5	24
16	5 to 30	35.3	17	5	40.3	22	10	13.5	25.5
20	5 to 50	41.2	19.5	7.5	51.2	29.5	17.5	14.5	28.5
25	5 to 50	44.7	22.5	7.5	54.7	32.5	17.5	15	32.5

Bore size (mm)	LD	LG	LH	LT	LX	LY	LZ	X	Y
12	4.5	2.8	17	2	34	29.5	44	8	4.5
16	4.5	2.8	19	2	38	33.5	48	8	5
20	6.6	4	24	3.2	48	62	9.2	5.8	
25	6.6	4	26	3.2	52	46	66	10.7	5.8

Foot bracket material: Carbon steel
Surface treatment: Nickel plated

Compact Foot Style

Bore size (mm)	Standard stroke (mm)	Without auto switch			With auto switch			L	L1
		A	B	LS	A	B	LS		
12	5 to 30	49.6	22	40.6	54.6	27	45.6	13.5	24
16	5 to 30	50.6	22	40.6	55.6	27	45.6	13.5	25.5
20	5 to 50	62.5	24.5	50.9	72.5	34.5	60.9	14.5	28.5
25	5 to 50	65.5	27.5	53.9	75.5	37.5	63.9	15	32.5

Bore size (mm)	LD	LH	LT	LX	LY	LZ	X	Y
12	4.5	17	2	15.5	29.5	25	9.3	4.5
16	4.5	19	2	20	33.5	29	9.3	5
20	6.6	24	3.2	25.5	42	36	13.2	5.8
25	6.6	26	3.2	28	46	40	13.2	5.8

Compact foot bracket material: Carbon steel
Surface treatment: Zinc chromated

Rod Side Flange Style

Bore size (mm)	Standard stroke (mm)	Without auto switch		With auto switch		FD	FT	FV	FX
		A	B	A	B				
12	5 to 30	30.5	17	35.5	22	4.5	5.5	25	45
16	5 to 30	30.5	17	35.5	22	4.5	5.5	30	45
20	5 to 50	34	19.5	44	29.5	6.6	8	39	48
25	5 to 50	37.5	22.5	47.5	32.5	6.6	8	42	52

Bore size (mm)	FZ	L	L1
12	55	13.5	24
16	55	13.5	25.5
20	60	14.5	28.5
25	64	15	32.5

Flange bracket material: Carbon steel
Surface treatment: Nickel plated

Head Side Flange Style (mm)

Bore size (mm)	Standard stroke (mm)	Without auto switch		With auto switch	
		A	B	A	B
12	5 to 30	26	17	31	22
16	5 to 30	26	17	31	22
20	5 to 50	32	19.5	42	29.5
25	5 to 50	35.5	22.5	45.5	32.5

Bore size (mm)	FD	FT	FV	FX	FZ	L	L1
12	4.5	5.5	25	45	55	3.5	14
16	4.5	5.5	30	45	55	3.5	15.5
20	6.6	8	39	48	60	4.5	18.5
25	6.6	8	42	52	64	5	22.5

Flange bracket material: Carbon steel
Surface treatment: Nickel plated

* For details about the rod end nut and accessory brackets, refer to page 1274.

Double clevis style: CQSXD/CDQSXD

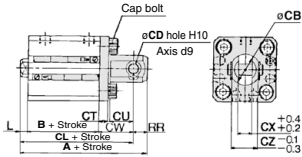

Rod end male thread

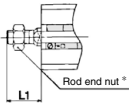

Double Clevis Style

(mm)

Bore size (mm)	Standard stroke (mm)	Without auto switch			With auto switch					
		A	B	CL	A	B	CL	L	L1	RR
12	5 to 30	40.5	17	34.5	45.5	22	39.5			
16	5 to 30	41.5	17	35.5	46.5	22	40.5			
20	5 to 50	51	19.5	42	61	29.5	52			
25	5 to 50	57.5	22.5	47.5	67.5	32.5	57.5			

Bore size (mm)	CB	CD	CT	CU	CW	CX	CZ	L	L1	RR
12	12	5	4	7	14	5	10	3.5	14	6
16	14	5	4	10	15	6.5	12	3.5	15.5	6
20	20	8	5	12	18	8	16	4.5	18.5	9
25	24	10	5	14	20	10	20	5	22.5	10

Double clevis bracket material: Carbon steel
Surface treatment: Nickel plated

* For details about the rod end nut and accessory brackets, refer to page 1274.

Series CQSX Auto Switch Mounting

Minimum Auto Switch Mounting Stroke

Qty. of auto switches mounted	(mm)						
	D-M9□V	D-A9□V	D-M9□WV D-M9□AV	D-A9□	D-M9□W D-M9□A	D-M9□	D-P3DW (Note 1)
1 pc.	5	5	10	10(5)	15 (10)	15 (5)	15
2 pcs.	5	10	10	10	15 (10)	15 (5)	15

Note 1) ø25 is only applicable for D-P3DW□.

Note 2) The dimensions stated in () shows the minimum stroke for the auto switch mounting when the auto switch does not project from the end surface of the cylinder body and hinder the lead wire bending space. (Refer to the figure on the right.)

Order auto switches separately.



Auto Switch Proper Mounting Position (Detection at Stroke End) and Its Mounting Height

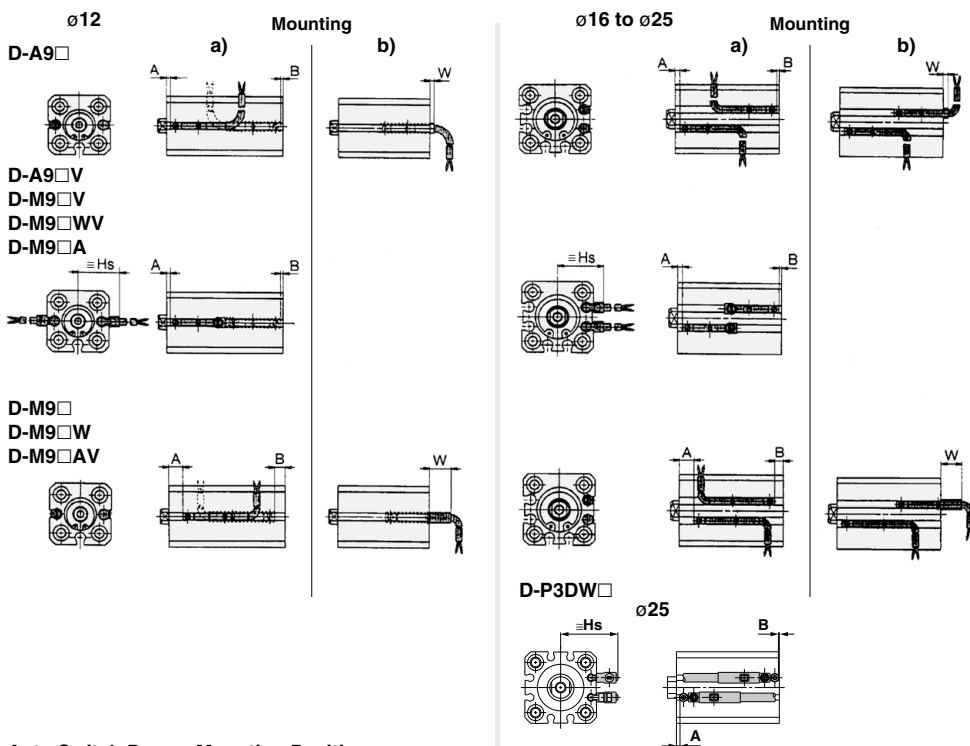

Auto Switch Proper Mounting Position

Auto switch model Bore size	D-A9□			D-A9□V			D-M9□/ M9□W			D-M9□A			D-M9□V/ M9□WV D-M9□AV			D-P3DW		
	A	B	W	A	B	Hs	A	B	W	A	B	W	A	B	Hs	A	B	Hs
12	1.5	0	[1.5] 4	1.5	0	17	5.5	3.5	5.5	5.5	3.5	7.5	5.5	4.5	19.5	—	—	—
16	2	0	[2] 4.5	2	0	19	6	4	6	6	4	8	6	4	21.5	—	—	—
20	6	3.5	[-1.5] 1	6	3.5	22.5	10	7.5	2.5	10	7.5	4.5	10	7.5	25	—	—	—
25	7	5.5	[-3.5] -1	7	5.5	24.5	11	9.5	0.5	11	9.5	2.5	11	9.5	27	1.5	0	32

[] : Denotes the values of D-A96.

Note 1) Adjust the auto switch after confirming the operating conditions in the actual setting.

Note 2) The product is shipped out of the factory in installation state "a)". To change the electrical entry direction of the switch on the head, refer to installation state "b)".

Note 3) Negative figures for W indicate an auto switch is mounted inward from the edge of the cylinder body.

Operating Range

Auto switch model	Bore size (mm)			
	12	16	20	25
D-A9□/A9□V	6	7.5	10	10
D-M9□/M9□V D-M9□W/M9□WV D-M9□A/M9□AV	3	4	5.5	4.5
D-P3DW	—	—	—	5.5

* Since this is a guideline including hysteresis, not meant to be guaranteed.
(assuming approximately ±30% dispersion.)

There may be the case it will vary substantially depending on an ambient environment.

Other than the applicable auto switches listed in “How to Order”, the following auto switches can be mounted.

* With pre-wired connector is available for solid state auto switches. For details, refer to pages 1960 to 1961.

* Normally closed (NC = b contact), solid state auto switches (D-F9G, F9H type) are also available. For details, refer to page 1911.

⚠ Precautions

Be sure to read before handling.

Refer to front matter 39 for Safety Instructions and pages 3 to 12 for Actuator and Auto Switch Precautions.

- If the cylinder is used in an application in which a magnetic material is placed in close contact around the cylinder as shown in the graph on the right (including cases in which even one of the sides is in close contact) the operation of auto switches could become unstable. Therefore, please check with SMC for this type of application.

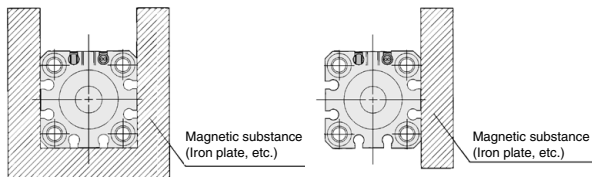

REA

REB

REC

C□Y

C□X

MQ

RHC

RZQ

D-□

-X□

Low Speed Cylinder: Standard Type

Double Acting, Single Rod

Series CQ2X

ø32, ø40, ø50, ø63, ø80, ø100

How to Order

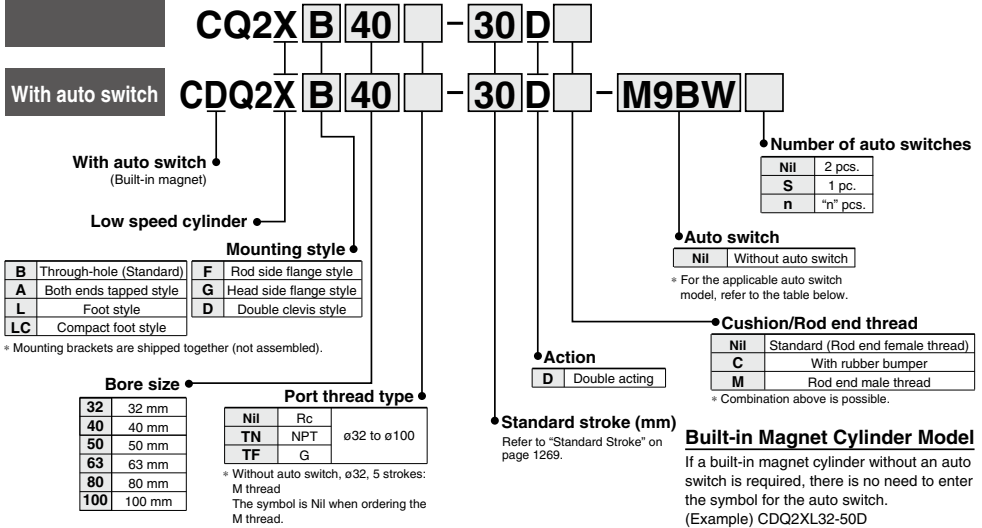

Applicable Auto Switches

Refer to pages 1893 to 2007 for further information on auto switches.

Type	Special function	Electrical entry	Indication	Wiring (Output)	Load voltage		Auto switch model		Lead wire length (m)					Pre-wired connector	Applicable load						
					DC	AC	Perpendicular	In-line	0.5 (Nil)	1 (M)	3 (L)	5 (Z)	None (N)								
Solid state auto switch	—	Grommet	No	3-wire (NPN)	24 V	—	5 V, 12 V	M9NV	M9N	●	●	○	—	—	IC circuit	Relay, PLC					
				3-wire (PNP)				M9PV	M9P	●	●	○	—	—							
		2-wire	M9BV	M9B				●	●	○	—	—	—								
		—	J79C	—				●	—	●	●	—	—								
	Diagnostic indication (2-color indication)	Connector	Yes	3-wire (NPN)	24 V	—	5 V, 12 V	M9NWV	M9NW	●	●	○	—	—	IC circuit						
				3-wire (PNP)				M9PWV	M9PW	●	●	○	—	—							
	Water resistant (2-color indication)	Grommet	No	2-wire	24 V	—	12 V	M9BWW	M9BW	●	●	○	—	—	—						
				3-wire (NPN)				M9NAV***	M9NA***	○	○	●	○	—			—				
	With diagnostic output (2-color indication)	Grommet	No	3-wire (PNP)	24 V	—	12 V	M9PAV***	M9PA***	○	○	●	○	—	IC circuit						
				2-wire				M9BAV***	M9BA***	○	○	●	○	—			—				
Magnetic field resistant (2-color indication)	Grommet	No	4-wire	24 V	—	5 V, 12 V	—	F79F	●	—	●	○	—	IC circuit							
			2-wire (Non-polar)				—	P3DW	●	—	●	●	—		—						
			—				—	P4DW**	—	—	●	●	—		—	—					
			—				—	—	—	—	●	—	—		—	—					
Reed auto switch	—	Grommet	Yes	3-wire (NPN equivalent)	24 V	—	5 V	A96V	A96	●	—	●	—	—	IC circuit	—					
				—				200 V	A72	A72H	●	—	●	—			—				
				—				100 V	A93V	A93	●	—	●	●			—	—			
		Connector	No	2-wire				24 V	—	5 V, 12 V	100 V or less	A90V	A90	●	—		●	—	—	IC circuit	
				—								A73C	—	●	—		●	●	—		—
				—								A80C	—	●	—		●	●	—		—
Diagnostic indication (2-color indication)	Grommet	Yes	—	24 V	—	5 V, 12 V	24 V or less	A79W	—	●	—	●	—	IC circuit							
			—				—	A79W	—	●	—	●	—		—						

*** Water resistant type auto switches can be mounted on the above models, but in such case SMC cannot guarantee water resistance. Consult with SMC regarding water resistant types with the above model numbers.

- Lead wire length symbols: 0.5 m Nil (Example) M9NV
1 m M (Example) M9NWV
3 m L (Example) M9NWL
5 m Z (Example) M9NWZ
None N (Example) J79CN
- Solid state auto switches marked with "○" are produced upon receipt of order.
- D-P4DW is compatible with ø40 to ø100.
- Only D-P4DW is assembled at the time of shipment.

* Since there are other applicable auto switches than listed, refer to page 1279 for details.

* For details about auto switches with pre-wired connector, refer to pages 1960 and 1961. For D-P3DW, refer to pages 1948 and 1949.

* When D-A9C(V)/M9C(V)/M9W(V) types M9C(A/V) with ø32 to ø50 are mounted on a side other than the port side, order auto switch mounting brackets separately. Refer to page 1278 for details.

* Auto switches are shipped together (not assembled).

Specifications



Symbol

Single rod/Without cushion

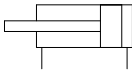

Single rod/Rubber bumper

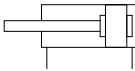

Bore size (mm)	32	40	50	63	80	100
Type	Pneumatic (Non-lube)					
Fluid	Air					
Proof pressure	1.5 MPa					
Maximum operating pressure	1.0 MPa					
Ambient and fluid temperature	Without auto switch: -10 to 70°C (No freezing) With auto switch: -10 to 60°C (No freezing)					
Cushion	None, Rubber bumper					
Rod end thread	Female thread					
Stroke length tolerance	+1.0 mm Note)					
Mounting	Through-hole					
Piston speed	0.5 to 300 mm/s					

Note) Stroke length tolerance does not include the amount of bumper change.

Minimum Operating Pressure

Bore size (mm)	32	40	50	63	80	100
Min. operating pressure (MPa)	0.025		0.01			

Standard Stroke

Bore size (mm)	Standard stroke (mm)
32, 40	5, 10, 15, 20, 25, 30, 35, 40, 45, 50, 75, 100
50, 63 80, 100	10, 15, 20, 25, 30, 35, 40, 45, 50, 75, 100

* Manufacturing of Intermediate stroke
Intermediate strokes by the 1 mm interval are available
by using spacers with standard stroke cylinders. But,
as for ø40 to ø100 with damper, please consult with
SMC separately.
Example) 18 mm width spacer is installed in the
standard cylinder CQ2XB40-75D to make
CQ2XB40-57D.

⚠ Precautions

Be sure to read before handling.
Refer to front matter 39 for Safety Instructions and pages 3 to 12 for Actuator and Auto Switch Precautions.

Retaining Ring Installation/Removal

⚠ Caution

- For installation and removal, use an appropriate pair of pliers (tool for installing a type C retaining ring).
- Even if a proper plier (tool for installing type C retaining ring) is used, it is likely to inflict damage to a human body or peripheral equipment, as a retaining ring may be flown out of the tip of a plier (tool for installing a type C retaining ring). Be much careful with the popping of a retaining ring. Besides, be certain that a retaining ring is placed firmly into the groove of rod cover before supplying air at the time of installment.

Pneumatic Circuit

- Pressure supplied to cylinder should be set affordably. When the operating pressure is low, low speed operation may not be stable depending on a load condition. Besides, the maximum speed may be restricted depending on a pneumatic circuit, or operating pressure.

Maintenance

⚠ Caution

1. Replacement parts/Seal kit

Order it in accordance with the bore size.

Bore size (mm)	Kit no.	Contents
32	CQ2X32-PS	Piston seal: 1 pc.
40	CQ2X40-PS	Rod seal: 1 pc.
50	CQ2X50-PS	Gasket: 1 pc.
63	CQ2X63-PS	Grease pack (10 g): 1 pc.
80	CQ2X80-PS	
100	CQ2X100-PS	

2. Grease pack

When maintenance requires only grease, use the following part numbers to order.

Grease pack part no.:

- GR-L-005 (5 g)
- GR-L-010 (10 g)
- GR-L-150 (150 g)

Mounting Bracket Part No.

Bore size (mm)	Foot ⁽¹⁾	Compact foot	Flange	Double clevis ⁽³⁾
32	CQ-L032	CQ-LC032	CQ-F032	CQ-D032
40	CQ-L040	CQ-LC040	CQ-F040	CQ-D040
50	CQ-L050	CQ-LC050	CQ-F050	CQ-D050
63	CQ-L063	CQ-LC063	CQ-F063	CQ-D063
80	CQ-L080	CQ-LC080	CQ-F080	CQ-D080
100	CQ-L100	CQ-LC100	CQ-F100	CQ-D100

Note 1) When ordering foot bracket, order 2 pieces per cylinder.

Note 2) Parts belonging to each bracket are as follows.
Foot, Compact foot, Flange: Body mounting bolts
Double clevis: Clevis pin, Type C retaining ring for shaft, Body mounting bolts

Note 3) For double clevis style, clevis pin and retaining ring are shipped together.

REA

REB

REC

CQY

CQX

MQ

RHC

RZQ

D-□

-X□

Series CQ2X

Bore size

ø32 to ø50

Basic style (Through hole type): CQ2XB/CDQ2XB

H thread effective depth C

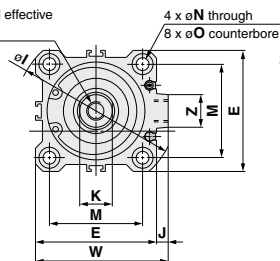

Both ends tapped style: CQ2XA/CDQ2XA

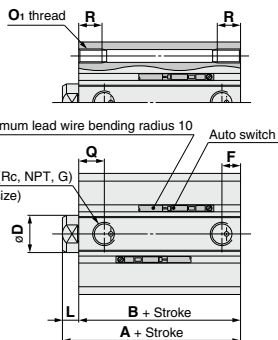

Both ends tapped

(mm)		
Bore size (mm)	O ₁	R
32	M6 x 1.0	10
40	M6 x 1.0	10
50	M8 x 1.25	14

Rod end male thread

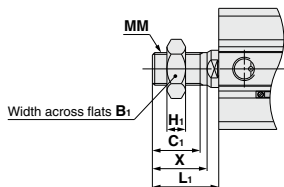

Rod End Male Thread

(mm)						
Bore size (mm)	B ₁	C ₁	H ₁	L ₁	MM	X
32	22	20.5	8	28.5	M14 x 1.5	23.5
40	22	20.5	8	28.5	M14 x 1.5	23.5
50	27	26	11	33.5	M18 x 1.5	28.5

Basic Style For the auto switch mounting position and its mounting height, refer to page 1276.

Bore size (mm)	Stroke range (mm)	Without auto switch					With auto switch					C	D	E	H	I	J	K	L	M
		A	B	F	P	Q	A	B	F	P	Q									
32	5	30	23	5.5	M5 x 0.8	11.5	40	33	7.5	1/8	10.5	13	16	45	M8 x 1.25	60	4.5	14	7	34
	10 to 50	40	33	7.5	1/8	10.5	40	33	7.5	1/8	10.5	13	16	45	M8 x 1.25	60	4.5	14	7	34
	75, 100	40	33	7.5	1/8	10.5	40	33	7.5	1/8	10.5	13	16	45	M8 x 1.25	60	4.5	14	7	34
40	5 to 50	36.5	29.5	8	1/8	11	46.5	39.5	8	1/8	11	13	16	52	M8 x 1.25	69	5	14	7	40
	75, 100	46.5	39.5	8	1/8	11	46.5	39.5	8	1/8	11	13	16	52	M8 x 1.25	69	5	14	7	40
	10 to 50	38.5	30.5	10.5	1/4	10.5	48.5	40.5	10.5	1/4	10.5	15	20	64	M10 x 1.5	86	7	17	8	50
50	75, 100	48.5	40.5	10.5	1/4	10.5	48.5	40.5	10.5	1/4	10.5	15	20	64	M10 x 1.5	86	7	17	8	50

Bore size (mm)	N	O	S	U	W	Z
32	5.5	9 depth 7	58.5	31.5	49.5	14
40	5.5	9 depth 7	66	35	57	14
50	6.6	11 depth 8	80	41	71	19

Note 1) Dimensions for rubber bumper are same as the standard style above.

* For details about the rod end nut and accessory brackets, refer to page 1274.

Note 2) Refer to page 1269 for calculation of the longitudinal dimension of the intermediate strokes since there is the spacer-installed type.

Foot style: CQ2XL/CDQ2XL

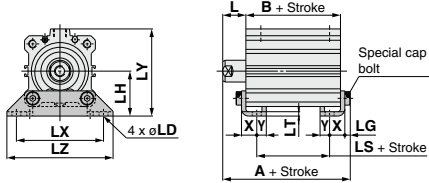

Rod end male thread

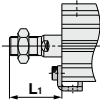

Compact Foot Style: CQ2XLC/CDQ2XLC

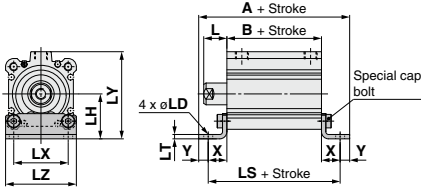

Rod end male thread

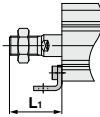

Rod side flange style: CQ2XF/CDQ2XF

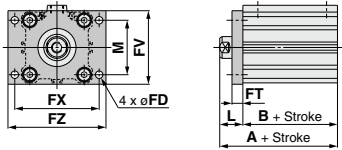

Rod end male thread

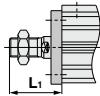

Head side flange style: CQ2XG/CDQ2XG

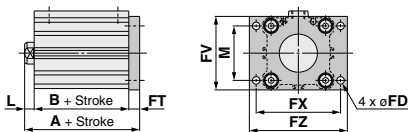

Rod end male thread



Applicable to { Head side flange style
Double clevis style

Foot Style

Bore size (mm)	Standard stroke (mm)	Without auto switch			With auto switch			L	L ₁	LD
		A	B	LS	A	B	LS			
32	5 to 50	47.2	23	7	57.2	33	17	17	38.5	6.6
	75, 100	57.2	33	17						
40	5 to 50	53.7	29.5	13.5	63.7	39.5	23.5	17	38.5	6.6
	75, 100	63.7	39.5	23.5						
50	10 to 50	56.7	30.5	7.5	66.7	40.5	17.5	18	43.5	9
	75, 100	66.7	40.5	17.5						

Foot bracket material: Carbon steel
Surface treatment: Nickel plated

Compact Foot Style

Bore size (mm)	Standard stroke (mm)	Without auto switch			With auto switch			L	L ₁	LD
		A	B	LS	A	B	LS			
32	5 to 50	72	33	60.4	82	43	70.4	17	38.5	6.6
	75, 100	82	43	70.4						
40	5 to 50	80.9	39.5	66.9	90.9	49.5	76.9	17	38.5	6.6
	75, 100	90.9	49.5	76.9						
50	10 to 50	89.9	40.5	73.9	99.9	50.5	83.9	18	43.5	9
	75, 100	99.9	50.5	83.9						

Foot bracket material: Carbon steel
Surface treatment: Nickel plated

Bore size (mm)	Standard stroke (mm)	LH	LT	LX	LY	LZ	X	Y	
32	5 to 50	4	30	3.2	57	57	71	11.2	5.8
	75, 100								
40	5 to 50	4	33	3.2	64	64	78	11.2	7
	75, 100								
50	10 to 50	5	39	3.2	79	78	95	14.7	8
	75, 100								

Compact foot bracket material: Carbon steel
Surface treatment: Zinc chromated

Rod Side Flange Style

Bore size (mm)	Standard stroke (mm)	Without auto switch		With auto switch		FD	FT	FV	FX	FZ
		A	B	A	B					
32	5 to 50	40	23	50	33	5.5	8	48	56	65
	75, 100	50	33							
40	5 to 50	46.5	29.5	56.5	39.5	5.5	8	54	62	72
	75, 100	56.5	39.5							
50	10 to 50	48.5	30.5	58.5	40.5	6.6	9	67	76	89
	75, 100	58.5	40.5							

Foot bracket material: Carbon steel
Surface treatment: Nickel plated

Bore size (mm)	Standard stroke (mm)	L	L ₁	M
32	5 to 50	17	38.5	34
	75, 100			
40	5 to 50	17	38.5	40
	75, 100			
50	10 to 50	18	43.5	50
	75, 100			

Head Side Flange Style

Bore size (mm)	Standard stroke (mm)	Without auto switch		With auto switch	
		A	A	L	L ₁
32	5 to 50	38	48	7	28.5
	75, 100	48			
40	5 to 50	44.5	54.5	7	28.5
	75, 100	54.5			
50	10 to 50	47.5	57.5	8	33.5
	75, 100	57.5			

Foot bracket material: Carbon steel
Surface treatment: Nickel plated

(* Dimensions except A, L and L₁ are the same as rod side flange style.)

* For details about the rod end nut and accessory brackets, refer to page 1274.

REA

REB

REC

□Y

□X

MQ

RHC

RZQ

D-□

-X□

Double clevis style: CQ2XD/CDQ2XD

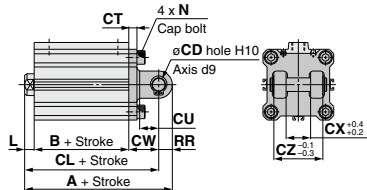

Rod end male thread



Double Clevis Style

(mm)

Bore size (mm)	Standard stroke (mm)	Without auto switch			With auto switch			CD	CT	CU
		A	B	CL	A	B	CL			
32	5 to 50	60	23	50	70	33	60	10	5	14
	75, 100	70	33	60						
40	5 to 50	68.5	29.5	58.5	78.5	39.5	68.5	10	6	14
	75, 100	78.5	39.5	68.5						
50	10 to 50	80.5	30.5	66.5	90.5	40.5	76.5	14	7	20
	75, 100	90.5	40.5	76.5						

Bore size (mm)	Standard stroke (mm)	CW	CX	CZ	L	L ₁	N	RR
32	5 to 50	20	18	36	7	28.5	M6 x 1.0	10
	75, 100							
40	5 to 50	22	18	36	7	28.5	M6 x 1.0	10
	75, 100							
50	10 to 50	28	22	44	8	33.5	M8 x 1.25	14
	75, 100							

Double clevis bracket material: Carbon steel
Surface treatment: Painted

- * For details about the rod end nut and accessory brackets, refer to page 1274.
- * Clevis pin and retaining ring are shipped together.

Series CQ2X

Bore size

Ø63 to Ø100

Both ends tapped style: CQ2XA/CDQ2XA

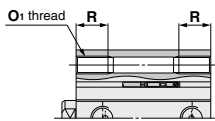

Both ends tapped

Bore size (mm)	(mm)	
	O ₁	R
63	M10 x 1.5	18
80	M12 x 1.75	22
100	M12 x 1.75	22

Basic style (Through hole type):

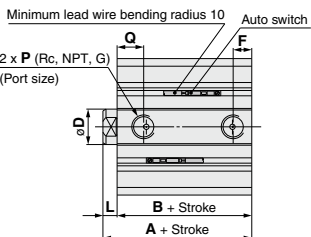
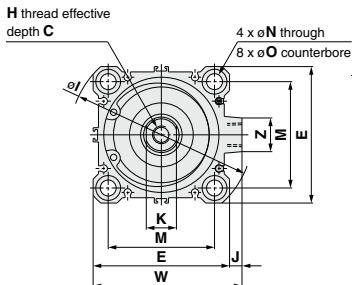

Rod end male thread

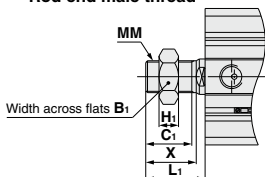

Both ends tapped

Bore size (mm)	(mm)					
	B ₁	C ₁	H ₁	L ₁	MM	X
63	27	26	11	33.5	M18 x 1.5	28.5
80	32	32.5	13	43.5	M22 x 1.5	35.5
100	41	32.5	16	43.5	M26 x 1.5	35.5

Basic Style For the auto switch mounting position and its mounting height, refer to page 1276.

Bore size (mm)	Stroke range (mm)	Without auto switch		With auto switch		C	D	E	F	H	I	J	K	L	M	N	O	P	Q	S
		A	B	A	B															
63	10 to 50	44	36	54	46	15	20	77	10.5	M10 x 1.5	103	7	17	8	60	9	14 depth 10.5	1/4	15	93
	75, 100	54	46																	
80	10 to 50	53.5	43.5	63.5	53.5	21	25	98	12.5	M16 x 2.0	132	6	22	10	77	11	17.5 depth 13.5	3/8	16	112.5
	75, 100	63.5	53.5																	
100	10 to 50	65	53	75	63	27	30	117	13	M20 x 2.5	156	6.5	27	12	94	11	17.5 depth 13.5	3/8	23	132.5
	75, 100	75	63																	

Bore size (mm)	(mm)		
	U	W	Z
63	47.5	84	19
80	57.5	104	26
100	67.5	123.5	26

Note 1) Dimensions for rubber bumper are same as the standard style above.
 * For details about the rod end nut and accessory brackets, refer to page 1274.
 Note 2) Refer to the Stroke Table on page 1269 for calculation of the longitudinal dimension of the intermediate strokes.

Foot style: CQ2XL/CDQ2XL

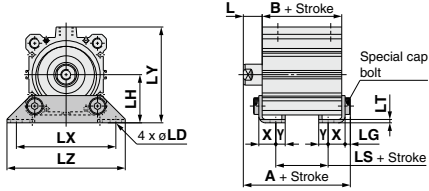

Rod end male thread

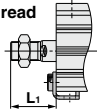

Compact foot style: CQ2XLC/CDQ2XLC

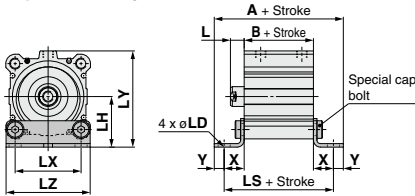

Rod end male thread

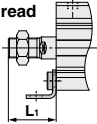

Rod side flange style: CQ2XF/CDQ2XF

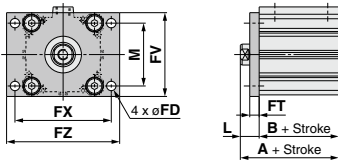

Rod end male thread

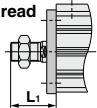

Head side flange style: CQ2XG/CDQ2XG

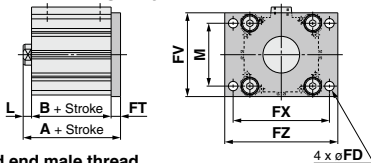

Rod end male thread

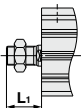

Foot Style

Bore size (mm)	Standard stroke (mm)	Without auto switch			With auto switch			L	L ₁	LD	LG	LH	LT
		A	B	LS	A	B	LS						
63	10 to 50	62.2	36	10	72.2	46	20	18	43.5	11	5	46	3.2
	75, 100	72.2	46	20									
80	10 to 50	75	43.5	13.5	85	53.5	23.5	20	53.5	13	7	59	4.5
	75, 100	85	53.5	23.5									
100	10 to 50	88	53	19	98	63	29	22	53.5	13	7	71	6
	75, 100	98	63	29									

Foot bracket material: Carbon steel
Surface treatment: Nickel plated

Bore size (mm)	Standard stroke (mm)	LX	LY	X	Y
63	10 to 50	95	91.5	113	16.2
	75, 100	95	91.5	113	16.2
80	10 to 50	118	114	140	19.5
	75, 100	118	114	140	19.5
100	10 to 50	137	136	162	23
	75, 100	137	136	162	23

Compact Foot Style

Bore size (mm)	Standard stroke (mm)	Without auto switch			With auto switch			L	L ₁	LD
		A	B	LS	A	B	LS			
63	10 to 50	100.4	46	82.4	110.4	56	92.4	18	43.5	11
	75, 100	110.4	56	92.4						
80	10 to 50	120.5	53.5	98.5	130.5	63.5	108.5	20	53.5	13
	75, 100	130.5	63.5	108.5						
100	10 to 50	136	63	111	146	73	121	22	53.5	13
	75, 100	146	73	121						

Bore size (mm)	Standard stroke (mm)	LH	LT	LX	LY	LZ	X	Y
63	10 to 50	46	3.2	60	91.5	77	18.2	9
	75, 100	46	3.2	60	91.5	77	18.2	9
80	10 to 50	59	4.5	77	114	98	22.5	11
	75, 100	59	4.5	77	114	98	22.5	11
100	10 to 50	71	6	94	136	117	24	12.5
	75, 100	71	6	94	136	117	24	12.5

Compact foot bracket material: Carbon steel
Surface treatment: Zinc chromated

Rod Side Flange Style

Bore size (mm)	Standard stroke (mm)	Without auto switch		With auto switch		FD	FT	FV	FX	FZ	L	L ₁	M
		A	B	A	B								
63	10 to 50	54	36	64	46	9	9	80	92	108	18	43.5	60
	75, 100	64	46	64	46	9	9	80	92	108	18	43.5	60
80	10 to 50	63.5	43.5	73.5	53.5	11	11	99	116	134	20	53.5	77
	75, 100	73.5	53.5	73.5	53.5	11	11	99	116	134	20	53.5	77
100	10 to 50	75	53	85	63	11	11	117	136	154	22	53.5	94
	75, 100	85	63	85	63	11	11	117	136	154	22	53.5	94

Foot bracket material: Carbon steel
Surface treatment: Nickel plated

Head Side Flange Style

Bore size (mm)	Standard stroke (mm)	Without auto switch		With auto switch		L	L ₁
		A	B	A	B		
63	10 to 50	53	36	63	46	8	33.5
	75, 100	63	46	63	46	8	33.5
80	10 to 50	64.5	43.5	74.5	53.5	10	43.5
	75, 100	74.5	53.5	74.5	53.5	10	43.5
100	10 to 50	76	53	86	63	12	43.5
	75, 100	86	63	86	63	12	43.5

Foot bracket material: Carbon steel
Surface treatment: Nickel plated

(* Dimensions except A, L and L₁ are the same as rod side flange style.)

* For details about the rod end nut and accessory brackets, refer to page 1274.

REA

REB

REC

COY

COX

MQ

RHC

RZQ

D-□

-X□

Double clevis style: CQ2XD/CDQ2XD

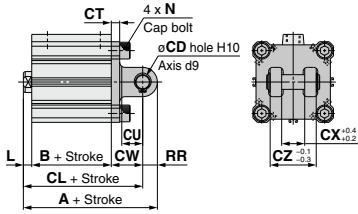

Rod end male thread

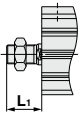

Double Clevis Style

(mm)

Bore size (mm)	Standard stroke (mm)	Without auto switch			With auto switch			CD	CT	CU	CW	CX
		A	B	CL	A	B	CL					
63	10 to 50	88	36	74	98	46	84	14	8	20	30	22
	75, 100	98	46	84								
80	10 to 50	109.5	43.5	91.5	119.5	53.5	101.5	18	10	27	38	28
	75, 100	119.5	53.5	101.5								
100	10 to 50	132	53	110	142	63	120	22	13	31	45	32
	75, 100	142	63	120								

Double clevis bracket material:

Cast iron

Surface treatment: Painted

Bore size (mm)	Standard stroke (mm)	CZ	L	L ₁	N	RR
63	10 to 50	44	8	33.5	M10 x 1.5	14
	75, 100					
80	10 to 50	56	10	43.5	M12 x 1.75	18
	75, 100					
100	10 to 50	64	12	43.5	M12 x 1.75	22
	75, 100					

* For details about the rod end nut and accessory brackets, refer to page 1274.

* Clevis pin and retaining ring are shipped together.

Accessory Bracket Dimensions

Single Knuckle Joint

For I-G012, I-Z015A
I-G02, I-G03

For I-G04, I-G05
I-G08, I-G10

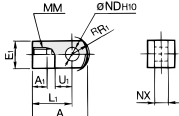

Material: Carbon steel
Surface material: Nickel plated

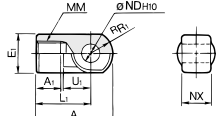

Material: Cast iron
Surface material: Nickel plated (mm)

Part no.	Applicable bore size (mm)	A	A ₁	E ₁	L ₁	MM	[°] R ₁	U ₁	ND _{H10}	NX
I-G04	32, 40	42	14	ø22	30	M14 x 1.5	12	14	10 ^{+0.058}	18 ^{-0.3}
I-G05	50, 63	56	18	ø28	40	M18 x 1.5	16	20	14 ^{+0.070}	22 ^{-0.3}
I-G08	80	71	21	ø38	50	M22 x 1.5	21	27	18 ^{+0.070}	28 ^{-0.3}
I-G10	100	79	21	ø44	55	M26 x 1.5	24	31	22 ^{+0.084}	32 ^{-0.3}

Double Knuckle Joint

For Y-G012, Y-Z015A
Y-G02, Y-G03

For Y-G04, Y-G05
Y-G08, Y-G10

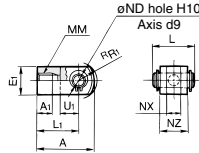

Material: Carbon steel
Surface material: Nickel plated

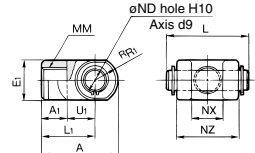

Material: Cast iron
Surface material: Nickel plated (mm)

Part no.	Applicable bore size (mm)	A	A ₁	E ₁	L ₁	MM	[°] R ₁	U ₁	ND _{H10}	NX	NZ	L	Applicable pin part no.
Y-G04	32, 40	42	16	ø22	30	M14 x 1.5	12	14	10 ^{+0.058}	18 ^{+0.5} 18 ^{-0.3}	36	41.5	IY-G04
Y-G05	50, 63	56	20	ø28	40	M18 x 1.5	16	20	14 ^{+0.070}	22 ^{+0.5} 22 ^{-0.3}	44	51.5	IY-G05
Y-G08	80	71	23	ø38	50	M22 x 1.5	21	27	18 ^{+0.070}	28 ^{+0.5} 28 ^{-0.3}	56	64	IY-G08
Y-G10	100	79	24	ø44	55	M26 x 1.5	24	31	22 ^{+0.084}	32 ^{+0.5} 32 ^{-0.3}	64	72	IY-G10

* Knuckle pin and retaining ring are included.

Knuckle Pin (Common with double clevis pin)

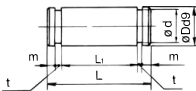

Material: Carbon steel
(mm)

Part no.	Applicable bore size (mm)	Dd9	L	d	L ₁	m	t	Applicable retaining ring
IY-G04	32, 40	10 ^{-0.040} 10 ^{-0.076}	41.6	9.6	36.2	1.55	1.15	Type C 10 for axis
IY-G05	50, 63	14 ^{-0.050} 14 ^{-0.093}	50.6	13.4	44.2	2.05	1.15	Type C 14 for axis
IY-G08	80	18 ^{-0.060} 18 ^{-0.093}	64	17	56.2	2.55	1.35	Type C 18 for axis
IY-G10	100	22 ^{-0.065} 22 ^{-0.117}	72	21	64.2	2.55	1.35	Type C 22 for axis

* Type C retaining rings for axis are included.

Rod End Nut

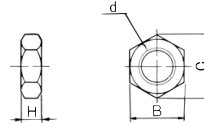

Material: Carbon steel
Surface material: Nickel plated
(mm)

Part no.	Applicable bore size (mm)	d	H	B	C
NT-04	32, 40	M14 x 1.5	8	22	25.4
NT-05	50, 63	M18 x 1.5	11	27	31.2
NT-08	80	M22 x 1.5	13	32	37.0
NT-10	100	M26 x 1.5	16	41	47.3

Simple Joint: $\phi 32$ to $\phi 100$

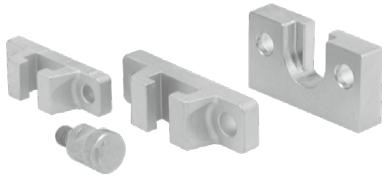

Joint and Mounting Bracket (Type A, Type B) Part No.

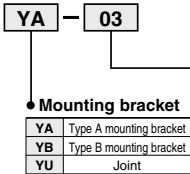

• Applicable air cylinder bore

03	For $\phi 32, \phi 40$
05	For $\phi 50, \phi 63$
08	For $\phi 80$
10	For $\phi 100$

Allowable Eccentricity (mm)

Bore size	$\phi 32$	$\phi 40$	$\phi 50$	$\phi 63$	$\phi 80$	$\phi 100$
Eccentricity tolerance		± 1			± 1.5	± 2
Backlash			0.5			

<Ordering>

- Joints are not included with the A or B type mounting brackets. Order them separately.

(Example)

- Bore size $\phi 40$ Part no.
- Type A mounting bracket part no.YA-03
- Joint.....YU-03

Joint and Mounting Bracket (Type A, Type B) Part No.

Bore size (mm)	Joint part no.	Applicable mounting bracket	
		Type A mounting bracket	Type B mounting bracket
32, 40	YU-03	YA-03	YB-03
50, 63	YU-05	YA-05	YB-05
80	YU-08	YA-08	YB-08
100	YU-10	YA-10	YB-10

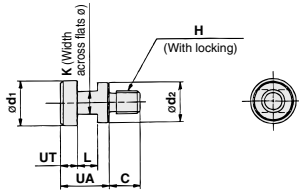

Material: Chromium molybdenum steel (Nickel plated)

Part no.	Applicable bor size (mm)	UA	C	d1	d2	H	K	L	UT	Weight (g)
YU-03	32, 40	17	11	15.8	14	M8 x 1.25	8	7	6	25
YU-05	50, 63	17	13	19.8	18	M10 x 1.5	10	7	6	40
YU-08	80	22	20	24.8	23	M16 x 2	13	9	8	90
YU-10	100	26	26	29.8	28	M20 x 2.5	14	11	10	160

Type A Mounting Bracket

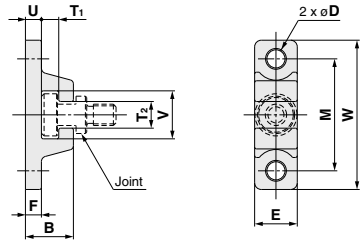

Material: Chromium molybdenum steel (Nickel plated) (mm)

Part no.	Bore size (mm)	B	D	E	F	M	T ₁	T ₂
YA-03	32,40	18	6.8	16	6	42	6.5	10
YA-05	50,63	20	9	20	8	50	6.5	12
YA-08	80	26	11	25	10	62	8.5	16
YA-10	100	31	14	30	12	76	10.5	18

Part no.	Bore size (mm)	U	V	W	Weight (g)
YA-03	32,40	6	18	56	55
YA-05	50,63	8	22	67	100
YA-08	80	10	28	83	195
YA-10	100	12	36	100	340

Type B Mounting Bracket

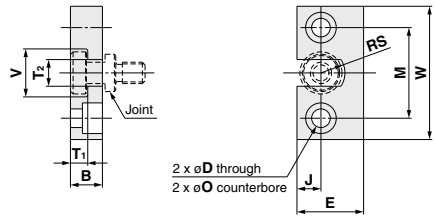

Material: Stainless steel (mm)

Part no.	Bore size (mm)	B	D	E	J	M	ϕO
YB-03	32, 40	12	7	25	9	34	11.5 depth 7.5
YB-05	50, 63	12	9	32	11	42	14.5 depth 8.5
YB-08	80	16	11	38	13	52	18 depth 12
YB-10	100	19	14	50	17	62	21 depth 14

Part no.	Bore size (mm)	T ₁	T ₂	V	W	RS	Weight (g)
YB-03	32, 40	6.5	10	18	50	9	80
YB-05	50, 63	6.5	12	22	60	11	120
YB-08	80	8.5	16	28	75	14	230
YB-10	100	10.5	18	36	90	18	455

REA

REB

REC

COY

COX

MQ

RHC

RZQ

D-□

-X□

Series CQ2X

Auto Switch Mounting 1

Auto Switch Proper Mounting Position (Detection at Stroke End) and Its Mounting Height

ø32 to ø100

- D-A9□ D-A9□V
- D-M9□ D-M9□V
- D-M9□W D-M9□WV
- D-M9□A D-M9□AV

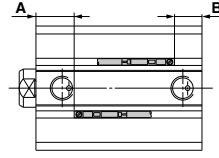
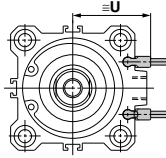
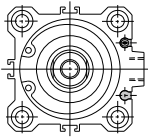

- D-A7□ D-F79F
- D-A80 D-F7NT
- D-A7□H D-A73C
- D-A80H D-A80C
- D-F7□ D-J79C
- D-J79 D-A79W
- D-F7□W D-F7□WV
- D-J79W D-F7□V

ø32 to ø100

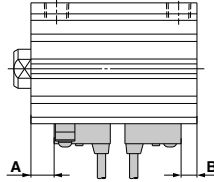
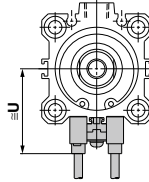

D-P3DW ø32 to ø100

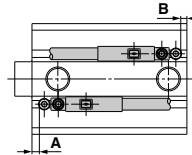
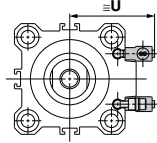

D-P4DW ø40 to ø100

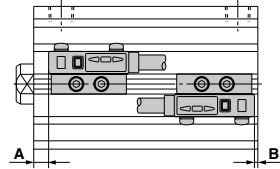
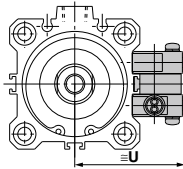

Auto Switch Proper Mounting Position

Auto switch model	D-A9□ D-A9□V		D-M9□ D-M9□V D-M9□W D-M9□WV D-M9□A D-M9□AV		D-A73 D-A80		D-A72/A□H/A80H D-A73C/A80C/F□ D-F79F/J79F/F□V D-J79C/F□WV		D-F7NT		D-A79W		D-P3DW		D-P4DW	
	A	B	A	B	A	B	A	B	A	B	A	B	A	B	A	B
Bore size	8	5	12	9	9	6	9.5	6.5	14.5	11.5	6.5	3.5	2.5	0	—	—
32	8	5	12	9	9	6	9.5	6.5	14.5	11.5	6.5	3.5	2.5	0	—	—
40	12	7.5	16	11.5	13	8.5	13.5	9	18.5	14	10.5	6	6.5	2	9	4.5
50	10	10.5	14	14.5	11	11.5	11.5	12	16.5	17	8.5	9	4.5	4.5	7	7.5
63	12.5	13.5	16.5	17.5	13.5	14.5	14	15	19	20	11	12	7	7.5	9.5	10.5
80	15.5	18	19.5	22	16.5	19	17	19.5	22	24.5	14	16.5	10	12	12.5	15
100	20	23	24	27	21	24	21.5	24.5	26.5	29.5	18.5	21.5	14.5	17.5	17	20

Note) Adjust the auto switch after confirming the operating conditions in the actual setting.

Auto Switch Mounting Height

Auto switch model	D-A9□V		D-M9□ D-M9□WV D-M9□AV		D-A7□ D-A80		D-A7□H D-A80H D-F7□/D-J79 D-F7□W D-J79W D-F79F D-F7NT		D-A73C D-A80C		D-F7□V D-F7□WV		D-J79C		D-A79W		D-P3DW		D-P4DW	
	U		U		U		U		U		U		U		U		U		U	
Bore size	27		29		31.5		32.5		38.5		35		38		34		34.5		—	
32	27		29		31.5		32.5		38.5		35		38		34		34.5		—	
40	30.5		32.5		35		36		42		38.5		41.5		37.5		38		44	
50	36.5		38.5		41		42		48		44.5		47.5		43.5		44		50	
63	40		42		47.5		48.5		54.5		51		54		50		47.5		56.5	
80	50		52		57.5		58.5		64.5		61		64		60		57.5		66.5	
100	60		62		67.5		68.5		74.5		71		74		70		67.5		76.5	

Minimum Auto Switch Mounting Stroke

(mm)											
No. of auto switches mounted	D-M9□V D-F7□V D-J79C	D-A9□V D-A7□ D-A80 D-A73C D-A80C	D-A9□	D-M9□WV D-M9□AV D-F7□WV	D-M9□ D-F7□ D-J79	D-M9□W D-M9□A	D-A7□H D-A80H	D-A79W	D-F7□W D-J79W D-F79F D-F7NT	D-P3DW	D-P4DW
1 pc.	5	5	10(5)	10	15(5)	15(10)	15(5)	15	20(10)	15	15
2 pcs.	5	10	10	15	15(5)	15	15(10)	20	20(15)	15	15

Note) The dimensions stated in () shows the minimum stroke for the auto switch mounting when the auto switch does not project from the end surface of the cylinder body and hinder the lead wire bending space. (Refer to the figure below.)
Order auto switches and auto switch mounting brackets separately.

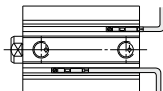

Operating Range

Auto switch model	Bore size					
	32	40	50	63	80	100
D-A9□(V)	9.5	9.5	9.5	11.5	9	11.5
D-M9□(V) D-M9□W(V) D-M9□A(V)	6	5.5	6.5	7.5	7.5	8.5
D-A7□(H)(C) D-A80□(H)(C)	12	11	10	12	12	13
D-A79W	13	14	14	16	15	17
D-F7□(V) D-J79(C) D-F7□W(V) D-F7NT D-F79F	6	6	6	6.5	6.5	7
D-P3DW	6.5	6.5	5.5	7.5	7	8.5
D-P4DW	—	5	5	5	5	5.5

- * Since this is a guideline including hysteresis, not meant to be guaranteed. (assuming approximately ±30% dispersion.)
There may be the case it will vary substantially depending on an ambient environment.
- * Auto switch mounting brackets BQ2-012 are not used for sizes over ø32 of D-A9□(V)/M9□(V)/M9□W(V)/M9□A(V) types. The above values indicate the operating range when mounted with the conventional auto switch installation groove.

- REA
- REB
- REC
- C□Y
- C□X
- MQ
- RHC
- RZQ

- D-□
- X□

Series CQ2X

Auto Switch Mounting 2

Auto Switch Mounting Bracket/Part No.

Auto switch mounting surface	Bore size (mm)	
	ø32, ø40, ø50	ø63, ø80, ø100
Auto switch model	Auto switch mounting surface	Auto switch mounting surface
	Port side	Port, A, B, C side
D-A9□ D-A9□V D-M9□ D-M9□V D-M9□W D-M9□WV D-M9□A D-M9□AV	No auto switch mounting bracket necessary. 	No auto switch mounting bracket necessary.

Note 1) For CDQ2□32 to 50, when a compact auto switch is mounted on the three sides (A, B and C above) other than the port side of bore sizes ø32 to ø50, the auto switch mounting brackets above are required. Order them separately from cylinders. (It is the same as when mounting compact cylinders with an auto switch mounting rail, but not with a compact auto switch installation groove for CDQ2□63 to 100.)

Example
 CDQ2XB32-100DM-M9BW.....1 unit
 BQ-2.....2 pcs.
 BQ2-012.....2 pcs.

Note 2) When the cylinder is shipped, an auto switch mounting bracket and auto switch are included in the shipment.

Auto switch model	Bore size (mm)	
	ø32	ø40 to ø100
D-A7□/A80 D-A73C/A80C D-A7□H/A80H D-A79W D-F7□/J79 D-F7□V D-J79C D-F7□W/J79W D-F7□WV D-F79F/F7NT		BQ-2
D-P3DW		BQ6-032S
D-P4DW	—	BQP1-050

Note) When the cylinder is shipped, an auto switch mounting bracket and auto switch are included in the shipment. However, ø40 to ø100 D-P4DW are assembled at the time of shipment.

Auto Switch Mounting Bracket Weight

Auto switch mounting bracket part no.	Applicable cylinder bore size	Weight (g)
BQ-2	ø32 to ø100	1.5
BQ6-032S	ø32 to ø100	5
BQP1-050	ø40 to ø100	16

Other than the applicable auto switches listed in "How to Order", the following auto switches can be mounted. For detailed specifications, refer to pages 1893 to 2007.

Auto switch type	Model	Electrical entry (Direction)	Features	Applicable bore size
Reed	D-A73	Grommet (Perpendicular)	—	ø32 to ø100
	D-A80		Without indicator light	
	D-A73H, A76H	Grommet (in-line)	—	
	D-A80H		Without indicator light	
Solid state	D-F7NV, F7PV, F7BV	Grommet (Perpendicular)	—	ø32 to ø100
	D-F7NWW, F7BWW		Diagnostic indication (2-color indication)	
	D-F79, F7P, J79	Grommet (in-line)	—	
	D-F79W, F7PW, J79W		Diagnostic indication (2-color indication)	
	D-F7NT		With timer	
	D-P5DW		Magnetic field resistant (2-color indication)	
			ø40 to ø100	

* With pre-wired connector is available for solid state auto switches. For details, refer to pages 1960 to 1961.

* Normally closed (NC = b contact) solid state auto switches (D-F9G/F9H/Y7G/Y7H types) are also available. Refer to pages 1911 and 1913 for details.

REA
 REB
 REC
 C□Y
C□X
 MQ
 RHC
 RZQ

D-□
 -X□

Low Speed Cylinder Double Acting, Single Rod Series **CM2X** ø20, ø25, ø32, ø40

How to Order

Mounting style

B	Basic style	T	Head side trunnion style
L	Axial foot style	E	Clevis integrated style
F	Rod side flange style	BZ	Boss-cut basic style
G	Head side flange style	FZ	Boss-cut rod side flange style
C	Single clevis style	UZ	Boss-cut rod side trunnion style
D	Double clevis style		
U	Rod side trunnion style		

Cylinder stroke (mm)
Refer to "Standard Stroke" on page 1281.

Auto switch mounting bracket ^(Note)
^(Note) This symbol is indicated when the D-A9□ or M9□ type auto switch is specified. This mounting bracket does not apply to other auto switches (D-C7□ and H7□, etc.) (Nil)

With auto switch **Low speed cylinder**

Thread type

Nil	Rc
TN	NPT
TF	G

Number of auto switches

Nil	2 pcs.
S	1 pc.
n	n pcs.

Auto switch

Nil	Without auto switch
-----	---------------------

Bore size

20	20 mm
25	25 mm
32	32 mm
40	40 mm

Built-in Magnet Cylinder Model
If a built-in magnet cylinder without an auto switch is required, there is no need to enter the symbol for the auto switch.
(Example) CDM2XF32-100

Applicable Auto Switches

Refer to pages 1893 to 2007 for further information on auto switches.

Type	Special function	Electrical entry	Indicating light	Wiring (Output)	Load voltage		Auto switch model		Lead wire (m)					Pre-wired connector	Applicable load					
					DC	AC	Perpendicular	In-line	0.5	1	3	5	None							
									(Nil)	(M)	(L)	(Z)				(N)				
Solid state auto switch	—	Grommet	Yes	3-wire (NPN)	5 V, 12 V	—	M9NV	M9N	●	●	○	—	—	○	IC circuit	Relay, PLC				
				3-wire (PNP)					●	●	○	—	—	○						
		Connector	Yes	2-wire	12 V	—	M9BV	M9B	●	●	○	—	—	○						
				3-wire (NPN)	24 V	5 V, 12 V	—	H7C	—	●	●	●	—	—						
	3-wire (PNP)	12 V	—	G39A											—		—	—	●	—
	Diagnostic indication (2-color)	Grommet	Yes	2-wire	5 V, 12 V	—	K39A	—	—	—	—	●	—	—	—					
				3-wire (NPN)													12 V	—	M9NVV	M9NV
		Terminal conduit	Yes	3-wire (PNP)	5 V, 12 V	—	M9PVV	M9PV	●	●	○	—	—	○						
				2-wire					12 V	—	M9BWW	M9BW	●	●	○		—	—	○	
		With diagnostic output (2-color)	Grommet	Yes	4-wire (NPN)	5 V, 12 V	—	H7NF	—	●	●	○	—	—	○		IC circuit			
3-wire (Equiv. NPN)					—	5 V	—	A96V	A96	●	●	○	—	—	—	IC circuit				
Reed auto switch	—	Grommet	No	2-wire	24 V	12 V	—	A93V	A93	●	—	●	—	—	—	IC circuit	Relay, PLC			
										100 V or less	A90V	A90	●	—	●			—	—	—
										100 V, 200 V	B54	●	—	●	—			—	—	—
										200 V or less	B64	●	—	●	—			—	—	—
										—	C73C	●	—	●	—			—	—	—
		Connector	No	2-wire	24 V	12 V	—	—	C80C	—	●	●	●	—	—	—		IC circuit		
																			—	A33A
		Terminal conduit	Yes	2-wire	24 V	12 V	—	—	A34A	—	—	—	—	●	—	—		—		
																			100 V, 200 V	A44A
		DIN terminal	Yes	2-wire	24 V	12 V	—	—	A44A	—	—	—	—	●	—	—		—		
100 V, 200 V	B59W																●		—	●
Grommet	Yes	2-wire	24 V	12 V	—	—	—	—	—	—	—	●	—	—	—					
																100 V, 200 V	B59W	●	—	●

* Lead wire length symbols: 0.5 m Nil (Example) M9NV
1 m M (Example) M9NWM
3 m L (Example) M9NWL
5 m Z (Example) M9NZL
None N (Example) H7CN

* Solid state auto switches marked with "○" are produced upon receipt of order.
* Do not add the suffix (N) indicating "no lead wire" to the part numbers of models D-A3□A, A44A, G39A and K39A.

* In addition to the models in the above table, there are some other auto switches that are applicable. For more information, refer to page 1293.
* Refer to pages 1960 and 1961 for details of auto switches with a pre-wired connector.
* D-A9□/M9□ auto switches are shipped together (not assembled). (Only auto switch mounting brackets are assembled before shipped.)



Symbol

Double acting, Single rod/Rubber bumper

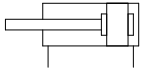

Standard Stroke

Bore size (mm)	Standard stroke (mm)
20	25, 50, 75, 100, 125, 150 200, 250, 300
25	
32	
40	

* Manufacture of intermediate strokes at 1 mm intervals is possible. (Spacers are not used.)

⚠ Precautions

Be sure to read before handling.
Refer to front matter 39 for Safety Instructions and pages 3 to 12 for Actuator and Auto Switch Precautions.

Operating Precautions

⚠ Warning

1. **Do not rotate the cover.**
 - When installing a cylinder or screwing a pipe fitting into the port, the coupling portion of the cover could break if the cover rotated.

⚠ Caution

1. **Be careful of the retaining ring to pop out.**
 - When replacing the rod seal, take care that the retaining ring does not spring out while you are removing it.

Maintenance

⚠ Caution

1. Replacement parts/Seal kit

Order it in accordance with the bore size.

Bore size (mm)	Kit no.	Contents
20	CM2X20-PS	Rod seal: 1 pc.
25	CM2X25-PS	
32	CM2X32-PS	Grease pack (10 g): 1 pc.
40	CM2X40-PS	

2. Grease pack

When maintenance requires only grease, use the following part numbers to order.

Grease pack part no.:

- GR-L-005 (5 g)
- GR-L-010 (10 g)
- GR-L-150 (150 g)

Specifications

Bore size (mm)	20	25	32	40
Type	Pneumatic			
Action	Double acting, Single rod			
Fluid	Air			
Proof pressure	1.5 MPa			
Maximum operating pressure	1.0 MPa			
Minimum operating pressure	0.025 MPa			
Ambient and fluid temperature	Without auto switch: -10 to 70°C (No freezing) With auto switch: -10 to 60°C (No freezing)			
Cushion	Rubber bumper			
Lubrication	Not required (Non-lube)			
Stroke length tolerance	+1.4 mm 0			

Piston Speed

Bore size (mm)	20	25	32	40
Piston speed (mm/s)	0.5 to 300			
Allowable kinetic energy (J)	0.27	0.4	0.65	1.2

Mounting Bracket Part No.

Mounting bracket	Minimum order	Bore size (mm)				Description (when ordering a minimum number)
		20	25	32	40	
Axial foot*	2	CM-L020B	CM-L032B	CM-L040B	CM-L040B	Foot 2 pcs., Mounting nut 1 pc.
Flange	1	CM-F020B	CM-F032B	CM-F040B	CM-F040B	Flange 1 pc.
Single clevis**	1	CM-C020B	CM-C032B	CM-C040B	CM-C040B	Single clevis 1 pc., Liner 3 pcs.
Double clevis (with pin)***	1	CM-D020B	CM-D032B	CM-D040B	CM-D040B	Double clevis 1 pc., Liner 3 pcs., Clevis pin 1 pc., Retaining ring 2 pcs.
Trunnion (with nut)	1	CM-T020B	CM-T032B	CM-T040B	CM-T040B	Trunnion 1 pc., Trunnion nut 1 pc.

* When ordering foot brackets, order 2 pieces per cylinder unit.

** Three liners are included in the clevis bracket for adjusting an angle when mounting it.

*** Clevis pin and retaining ring (cotter pin for ø40) are shipped together.

Mounting Style and Accessory

Accessory	Standard equipment			Option				
	Mounting nut	Rod end nut	Clevis pin	Single knuckle joint	Double (3) knuckle joint	Clevis (4) bracket	Pivot (6) bracket	Pivot (7) bracket pin
Mounting								
Basic style	● (1 pc.)	●	—	●	●	—		
Axial foot style	● (2)	●	—	●	●	—		
Rod side flange style	● (1)	●	—	●	●	—	—	—
Head side flange style	● (1)	●	—	●	●	—		
Clevis integrated style	— Note 1)	●	—	●	●	●		
Single clevis style	— Note 1)	●	—	●	●	—	●	●
Double clevis style (3)	— Note 1)	●	● Note 5)	●	●	—	—	—
Rod side trunnion style	● (1) Note 2)	●	—	●	●	—		
Head side trunnion style	● (1) Note 2)	●	—	●	●	—	●	—
Boss-cut basic style	● (1)	●	—	●	●	—		
Boss-cut flange style	● (1)	●	—	●	●	—	—	—
Boss-cut trunnion style	● (1)	●	—	●	●	—		

Note 1) Mounting nut is not equipped with clevis integrated style, single clevis style and double clevis style.

Note 2) Trunnion nuts are attached for rod side trunnion and head side trunnion styles.

Note 3) Pin and retaining ring are shipped together with double clevis and double knuckle joint. (ø40 is cotter pin.)

Note 4) Pins and retaining rings are packed with clevis brackets.

Note 5) Retaining rings (cotter pins for ø40) are included in the clevis pins.

Note 6) Pin brackets come with pins and retaining rings.

Note 7) Pivot bracket pins come with retaining rings.

REA

REB

REC

□CY

□CX

MQ

RHC

RZQ

D-□

-X□

Series CM2X

Basic Style (B)

CM2XB —

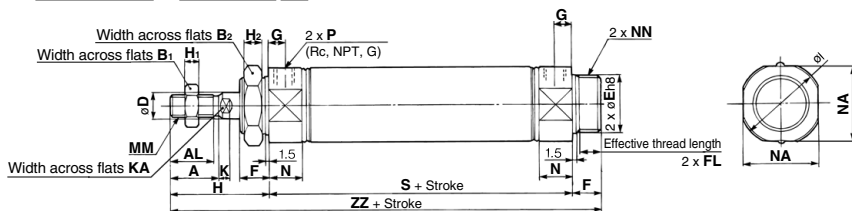

Boss-cut style

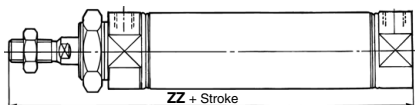

Bore size (mm)	A	AL	B ₁	B ₂	D	E	F	FL	G	H	H ₁	H ₂	I	K	KA	MM	N	NA	NN	P	S	ZZ
20	18	15.5	13	26	8	20 ⁰ _{-0.033}	13	10.5	8	41	5	8	28	5	8	M8 x 1.25	15	24	M20 x 1.5	1/8	62	116
25	22	19.5	17	32	10	26 ⁰ _{-0.033}	13	10.5	8	45	6	8	33.5	5.5	8	M10 x 1.25	15	30	M26 x 1.5	1/8	62	120
32	22	19.5	17	32	12	26 ⁰ _{-0.033}	13	10.5	8	45	6	8	37.5	5.5	10	M10 x 1.25	15	34.5	M26 x 1.5	1/8	64	122
40	24	21	22	41	14	32 ⁰ _{-0.039}	16	13.5	11	50	8	10	46.5	7	12	M14 x 1.5	21.5	42.5	M32 x 2	1/4	88	154

Boss-cut Style (mm)

Bore size (mm)	ZZ
20	103
25	107
32	109
40	138

Axial Foot Style (L)

CM2XL —

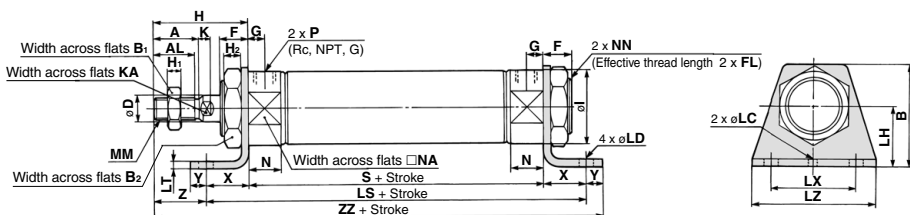

Bore size (mm)	A	AL	B	B ₁	B ₂	D	F	FL	G	H	H ₁	H ₂	I	K	KA	LC	LD	LH	LS	LT	LX	LZ	MM	N	NA	NN	P	S	X	Y	Z	ZZ
20	18	15.5	40	13	26	8	13	10.5	8	41	5	8	28	5	6	4	6.8	25	102	3.2	40	55	M8 x 1.25	15	24	M20 x 1.5	1/8	62	20	8	21	131
25	22	19.5	47	17	32	10	13	10.5	8	45	6	8	33.5	5.5	8	4	6.8	28	102	3.2	40	55	M10 x 1.25	15	30	M26 x 1.5	1/8	62	20	8	25	135
32	22	19.5	47	17	32	12	13	10.5	8	45	6	8	37.5	5.5	10	4	6.8	28	104	3.2	40	55	M10 x 1.25	15	34.5	M26 x 1.5	1/8	64	20	8	25	137
40	24	21	54	22	41	14	16	13.5	11	50	8	10	46.5	7	12	4	7	30	134	3.2	55	75	M14 x 1.5	21.5	42.5	M32 x 2	1/4	88	23	10	27	171

* Mounting bracket is supplied with the product.

Rod Side Flange Style (F)

CM2XF —

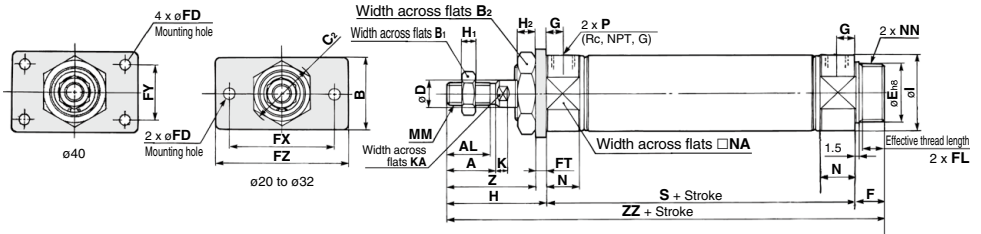

Boss-cut style

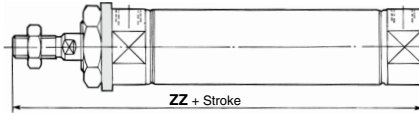

Bore size (mm)	A	AL	B	B ₁	B ₂	C ₂	D	E	F	FL	FD	FT	FX	FY	FZ	G	H	H ₁	H ₂	I	K	KA	MM	N	NA	NN	P	S	Z	ZZ
20	18	15.5	34	13	26	30	8	20 ^{-0.033}	13	10.5	7	4	60	—	75	8	41	5	8	28	5	6	M8 x 1.25	15	24	M20 x 1.5	1/8	62	37	116
25	22	19.5	40	17	32	37	10	26 ^{-0.033}	13	10.5	7	4	60	—	75	8	45	6	8	33.5	5.5	8	M10 x 1.25	15	30	M26 x 1.5	1/8	62	41	120
32	22	19.5	40	17	32	37	12	26 ^{-0.033}	13	10.5	7	4	60	—	75	8	45	6	8	37.5	5.5	10	M10 x 1.25	15	34.5	M26 x 1.5	1/8	64	41	122
40	24	21	52	22	41	47.3	14	32 ^{-0.039}	16	13.5	7	5	66	36	82	11	50	8	10	46.5	7	12	M14 x 1.5	21.5	42.5	M32 x 2	1/4	88	45	154

Boss-cut Style (mm)

Bore size (mm)	ZZ
20	103
25	107
32	109
40	138

* Mounting bracket is supplied with the product.

Head Side Flange Style (G)

CM2XG —

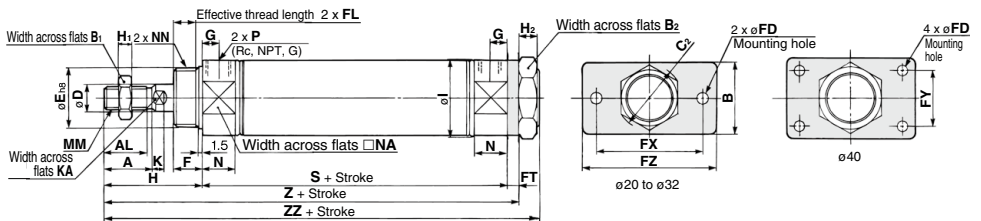

Bore size (mm)	A	AL	B	B ₁	B ₂	C ₂	D	E	F	FL	FD	FT	FX	FY	FZ	G	H	H ₁	H ₂	I
20	18	15.5	34	13	26	30	8	20 ^{-0.033}	13	10.5	7	4	60	—	75	8	41	5	8	28
25	22	19.5	40	17	32	37	10	26 ^{-0.033}	13	10.5	7	4	60	—	75	8	45	6	8	33.5
32	22	19.5	40	17	32	37	12	26 ^{-0.033}	13	10.5	7	4	60	—	75	8	45	6	8	37.5
40	24	21	52	22	41	47.3	14	32 ^{-0.039}	16	13.5	7	5	66	36	82	11	50	8	10	46.5

Bore size (mm)	K	KA	MM	N	NA	NN	P	S	Z	ZZ
20	5	6	M8 x 1.25	15	24	M20 x 1.5	1/8	62	107	116
25	5.5	8	M10 x 1.25	15	30	M26 x 1.5	1/8	62	111	120
32	5.5	10	M10 x 1.25	15	34.5	M26 x 1.5	1/8	64	113	122
40	7	12	M14 x 1.5	21.5	42.5	M32 x 2	1/4	88	143	154

* Mounting bracket is supplied with the product.

REA

REB

REC

COY

COX

MQ

RHC

RZQ

D-□

-X□

Series CM2X

Single Clevis Style (C)

CM2XC —

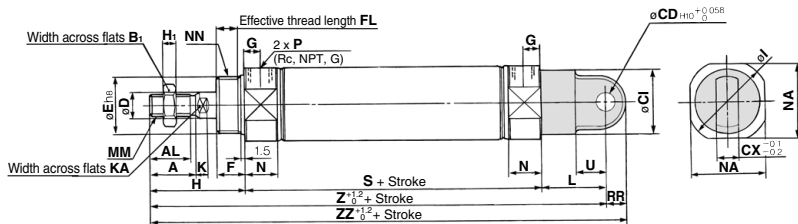

Bore size (mm)	A	AL	B ₁	CI	CD	CX	D	E	F	FL	G	H	H ₁	I	K	KA	L	MM	N	NA	NN	P	RR	S	U	Z	ZZ
20	18	15.5	13	24	9	10	8	20 ^{-0.033}	13	10.5	8	41	5	28	5	6	30	M8 x 1.25	15	24	M20 x 1.5	1/8	9	62	14	133	142
25	22	19.5	17	30	9	10	10	26 ^{-0.033}	13	10.5	8	45	6	33.5	5.5	8	30	M10 x 1.25	15	30	M26 x 1.5	1/8	9	62	14	137	146
32	22	19.5	17	30	9	10	12	26 ^{-0.033}	13	10.5	8	45	6	37.5	5.5	10	30	M10 x 1.25	15	34.5	M26 x 1.5	1/8	9	64	14	139	148
40	24	21	22	38	10	15	14	32 ^{-0.039}	16	13.5	11	50	8	46.5	7	12	39	M14 x 1.5	21.5	42.5	M32 x 2	1/4	11	88	18	177	188

Double Clevis Style (D)

CM2XD —

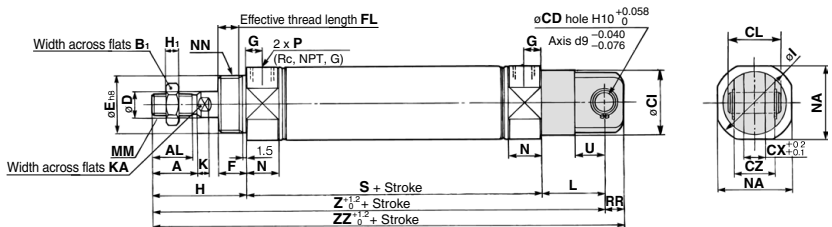

Bore size (mm)	A	AL	B ₁	CD	CL	CX	CZ	D	E	F	FL	G	H	H ₁	I	K	KA	L	MM	N	NA	NN	P	RR	S	U	Z	ZZ	
20	18	15.5	13	9	24	25	10	19	8	20 ^{-0.033}	13	10.5	8	41	5	28	5	6	30	M8 x 1.25	15	24	M20 x 1.5	1/8	9	62	14	133	142
25	22	19.5	17	9	30	25	10	19	10	26 ^{-0.033}	13	10.5	8	45	6	33.5	5.5	8	30	M10 x 1.25	15	30	M26 x 1.5	1/8	9	62	14	137	146
32	22	19.5	17	9	30	25	10	19	12	26 ^{-0.033}	13	10.5	8	45	6	37.5	5.5	10	30	M10 x 1.25	15	34.5	M26 x 1.5	1/8	9	64	14	139	148
40	24	21	22	10	38	41.2	15	30	14	32 ^{-0.039}	16	13.5	11	50	8	46.5	7	12	39	M14 x 1.5	21.5	42.5	M32 x 2	1/4	11	88	18	177	188

* Clevis pin and retaining ring (cotter pin for bore size ø40) are shipped together.

Rod Side Trunnion Style (U)

CM2XU Bore size – Stroke

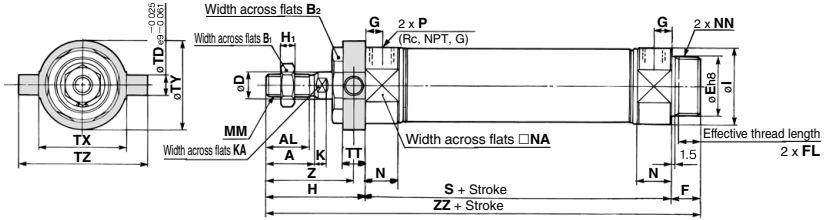

Boss-cut style

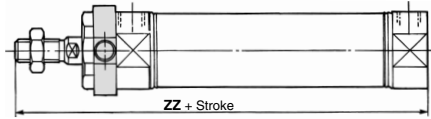

Bore size (mm)	A	AL	B ₁	B ₂	D	E	F	FL	G	H	H ₁	I	K	KA	MM	N	NA	NN	P
20	18	15.5	13	26	8	20 ⁰ _{-0.033}	13	10.5	8	41	5	28	5	6	M8 x 1.25	15	24	M20 x 1.5	1/8
25	22	19.5	17	32	10	26 ⁰ _{-0.033}	13	10.5	8	45	6	33.5	5.5	8	M10 x 1.25	15	30	M26 x 1.5	1/8
32	22	19.5	17	32	12	26 ⁰ _{-0.033}	13	10.5	8	45	6	37.5	5.5	10	M10 x 1.25	15	34.5	M26 x 1.5	1/8
40	24	21	22	41	14	32 ⁰ _{-0.039}	16	13.5	11	50	8	46.5	7	12	M14 x 1.5	21.5	42.5	M32 x 2	1/4

(mm)								
Bore size (mm)	S	TD	TT	TX	TY	TZ	Z	ZZ
20	62	8	10	32	32	52	36	116
25	62	9	10	40	40	60	40	120
32	64	9	10	40	40	60	40	122
40	88	10	11	53	53	77	44.5	154

* Mounting bracket is supplied with the product.

Boss-cut Style (mm)

Bore size (mm)	ZZ
20	103
25	107
32	109
40	138

- REA
- REB
- REC
- CQY
- CQX
- MQ
- RHC
- RZQ

- D-□
- X□

Series CM2X

Head Side Trunnion Style (T)

CM2XT –

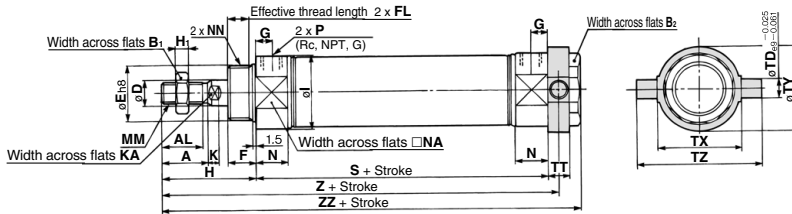

Bore size (mm)	A	AL	B ₁	B ₂	D	E	F	FL	G	H	H ₁	I	K	KA	MM	N	NA	NN	P
20	18	15.5	13	26	8	20 ⁰ _{-0.033}	13	10.5	8	41	5	28	5	6	M8 x 1.25	15	24	M20 x 1.5	1/8
25	22	19.5	17	32	10	26 ⁰ _{-0.033}	13	10.5	8	45	6	33.5	5.5	8	M10 x 1.25	15	30	M26 x 1.5	1/8
32	22	19.5	17	32	12	26 ⁰ _{-0.033}	13	10.5	8	45	6	37.5	5.5	10	M10 x 1.25	15	34.5	M26 x 1.5	1/8
40	24	21	22	41	14	32 ⁰ _{-0.039}	16	13.5	11	50	8	46.5	7	12	M14 x 1.5	21.5	42.5	M32 x 2	1/4

Bore size (mm)	S	TD	TT	TX	TY	TZ	Z	ZZ
20	62	8	10	32	32	52	108	118
25	62	9	10	40	40	60	112	122
32	64	9	10	40	40	60	114	124
40	88	10	11	53	53	77	143.5	154

* Mounting bracket is supplied with the product.

Clevis Integrated Style (E)

CM2XE —

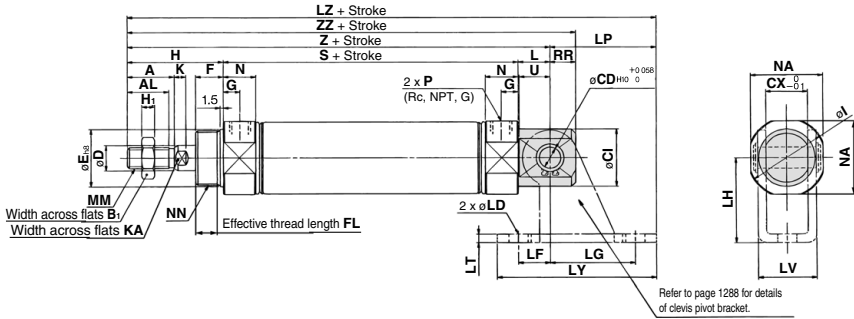

(mm)

Bore size (mm)	A	AL	B ₁	CD	CI	CX	D	E	F	FL	G	H	H ₁	I	K	KA	L	MM	N	NA	NN
20	18	15.5	13	8	20	12	8	20 ⁰ _{-0.033}	13	10.5	8	41	5	28	5	6	12	M8 x 1.25	15	24	M20 x 1.5
25	22	19.5	17	8	22	12	10	26 ⁰ _{-0.033}	13	10.5	8	45	6	33.5	5.5	8	12	M10 x 1.25	15	30	M26 x 1.5
32	22	19.5	17	10	27	20	12	26 ⁰ _{-0.033}	13	10.5	8	45	6	37.5	5.5	10	15	M10 x 1.25	15	34.5	M26 x 1.5
40	24	21	22	10	33	20	14	32 ⁰ _{-0.039}	16	13.5	11	50	8	46.5	7	12	15	M14 x 1.5	21.5	42.5	M32 x 2

(mm)

Bore size (mm)	P	RR	S	U	Z	ZZ
20	1/8	9	62	11.5	115	124
25	1/8	9	62	11.5	119	128
32	1/8	12	64	14.5	124	136
40	1/4	12	88	14.5	153	165

- REA
- REB
- REC
- D-Y
- D-X
- MQ
- RHC
- RZQ

- D-□
- X□

Series CM2X

Accessory Bracket Dimensions

Single Knuckle Joint

(mm)

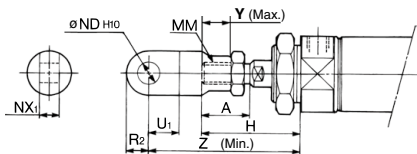

Bore size (mm)	A	H	MM	ND H10	NX1	U1	R2	Y	Z
20	18	41	M8 x 1.25	9 ^{+0.058} / ₀	9 ^{+0.1} / _{-0.2}	14	10	11	66
25, 32	22	45	M10 x 1.25	9 ^{+0.058} / ₀	9 ^{+0.1} / _{-0.2}	14	10	14	69
40	24	50	M14 x 1.5	12 ^{+0.070} / ₀	16 ^{+0.1} / _{-0.3}	20	14	13	92

Single Knuckle Joint

(mm)

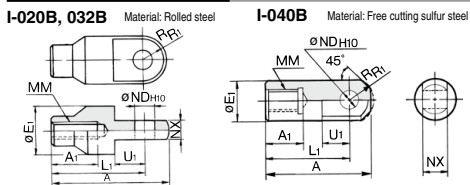

Part no.	Applicable bore size (mm)	A	A1	E1	L1	MM	ND H10	NX	R1	U1
I-020B	20	46	16	20	36	M8 x 1.25	9 ^{+0.058} / ₀	9 ^{+0.1} / _{-0.2}	10	14
I-032B	25, 32	48	18	20	38	M10 x 1.25	9 ^{+0.058} / ₀	9 ^{+0.1} / _{-0.2}	10	14
I-040B	40	69	22	24	55	M14 x 1.5	12 ^{+0.070} / ₀	16 ^{+0.1} / _{-0.3}	15.5	20

Double Knuckle Joint

(mm)

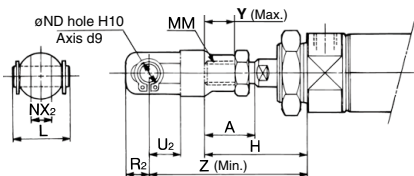

Bore size (mm)	A	H	L	MM	ND	NX2	R2	U2	Y	Z
20	18	41	25	M8 x 1.25	9	9 ^{+0.2} / _{-0.1}	10	14	11	66
25, 32	22	45	25	M10 x 1.25	9	9 ^{+0.2} / _{-0.1}	10	14	14	69
40	24	50	49.7	M14 x 1.5	12	16 ^{+0.3} / _{-0.1}	13	25	13	92

Double Knuckle Joint

(mm)

Y-020B, Y-032B Material: Rolled steel

Y-040B Material: Cast iron

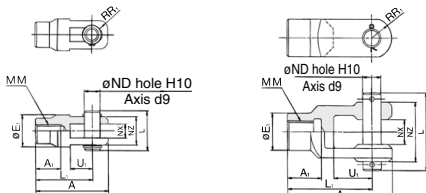

Part no.	Applicable bore size (mm)	A	A1	E1	L	L1	MM	ND	NX	NZ	R1	U1	Applicable pin part number	Retaining ring Coter pin size
Y-020B	20	46	16	20	25	36	M8 x 1.25	9	9 ^{+0.2} / _{-0.1}	18	5	14	CDP-1	Type C 9 for axis
Y-032B	25, 32	48	18	20	25	38	M10 x 1.25	9	9 ^{+0.2} / _{-0.1}	18	5	14	CDP-1	Type C 9 for axis
Y-040B	40	68	22	24	49.7	55	M14 x 1.5	12	16 ^{+0.3} / _{-0.1}	38	13	25	CDP-3	ø3 x 18 L

* Clevis pin and retaining ring (cotter pin for ø40) are attached.

Double Clevis Pin/Material: Carbon steel

(mm)

Bore size: ø20, ø25, ø32
CDP-1

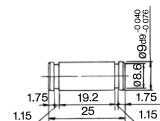

Retaining ring: Type C9 for axis

Bore size: ø40
CDP-2

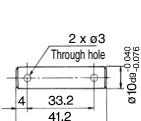

Cotter pin ø3 x 18 L

Double Knuckle Pin/Material: Carbon steel

(mm)

Bore size: ø20, ø25, ø32
CDP-1

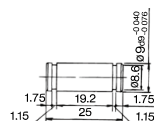

Retaining ring: Type C9 for axis

Bore size: ø40
CDP-3

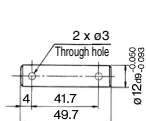

Cotter pin ø3 x 18 L

* Retaining rings (copper pins for ø40) are included.

* Retaining rings (copper pins for ø40) are included.

Rod End Nut (mm)

Material: Carbon steel

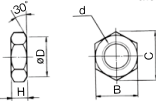

Part no.	Applicable bore size (mm)	B	C	D	d	H
NT-02	20	13	15.0	12.5	M8 x 1.25	5
NT-03	25, 32	17	19.6	16.5	M10 x 1.25	6
NT-04	40	22	25.4	21.0	M14 x 1.5	8

Mounting Nut (mm)

Material: Carbon steel

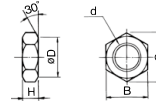

Part no.	Applicable bore size (mm)	B	C	D	d	H
SN-020B	20	26	30	25.5	M20 x 1.5	8
SN-032B	25, 32	32	37	31.5	M26 x 1.5	8
SN-040B	40	41	47.3	40.5	M32 x 2.0	10

Trunnion Nut (mm)

Material: Carbon steel

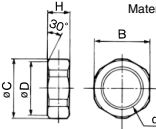

Part no.	Applicable bore size (mm)	B	C	D	d	H
TN-020B	20	26	28	25.5	M20 x 1.5	10
TN-032B	25, 32	32	34	31.5	M26 x 1.5	10
TN-040B	40	41	45	40.5	M32 x 2	10

Clevis Pivot Bracket (For CM2XE) (mm)

Material: Rolled steel plate

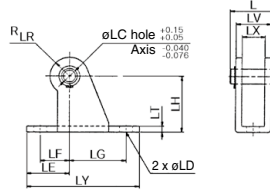

Part no.	Applicable bore size (mm)	L	LC	LD	LE	LF	LG	LH	LR	LT	LX	LY	LV	Applicable pin part no.
CM-E020B	20, 25	24.5	8	6.8	22	15	30	30	10	3.2	12	59	18.4	CD-S02
CM-E032B	32, 40	34	10	9	25	15	40	40	13	4	20	75	28	CD-S03

Note 1) Clevis bracket pins and retaining rings are included.

Note 2) It cannot be used for single clevis style (CM2C) and double clevis style (CM2D).

Clevis Pin (For CM2XE) (mm)

Material: Carbon steel

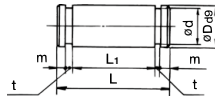

Part no.	Applicable bore size (mm)	D _{d9}	d	L	L ₁	m	t	Applicable retaining ring part no.
CD-S02	20, 25	8 ^{+0.040} _{-0.076}	7.6	24.5	19.5	1.6	0.9	Type C 8 for axis
CD-S03	32, 40	10 ^{+0.040} _{-0.076}	9.6	34	29	1.35	1.15	Type C 10 for axis

Note) Retaining rings are included.

Regarding mounting bracket, accessory made of stainless steel (Some are not available.), refer to page 2048 for -XB12, External stainless steel cylinder.

Refer to Best Pneumatics No.2 for pivot brackets.

REA

REB

REC

C□Y

C□X

MQ

RHC

RZQ

D-□

-X□

Series CM2X

Auto Switch Mounting 1

Auto Switch Proper Mounting Position (Detection at Stroke End) and Its Mounting Height

Reed auto switch

D-A9□

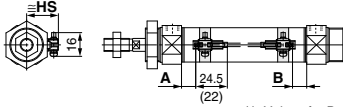

(): Values for D-A96
A and B are the dimensions from the end of the head cover/rod cover to the end of the auto switch.

D-A9□V

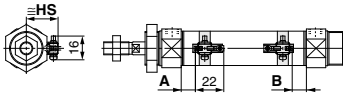

A and B are the dimensions from the end of the head cover/rod cover to the end of the auto switch.

D-C7/C8

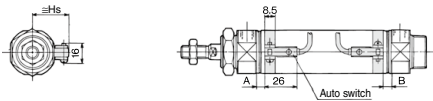

D-B5/B6/B59W

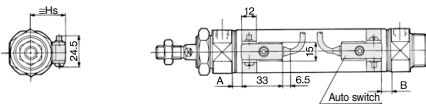

D-A33A/A34A

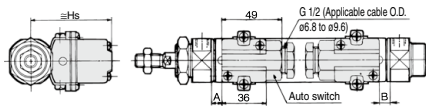

D-A44A

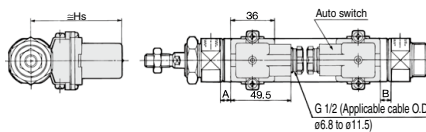

D-C73C/C80C

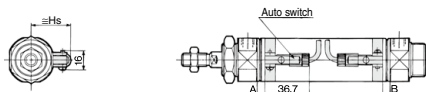

Solid state auto switch

D-M9□
D-M9□W
D-M9□A

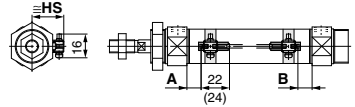

(): Values for D-M9□A
A and B are the dimensions from the end of the head cover/rod cover to the end of the auto switch.

D-M9□V
D-M9□WV
D-M9□AV

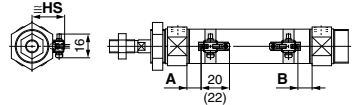

(): Values for D-M9□AV
A and B are the dimensions from the end of the head cover/rod cover to the end of the auto switch.

D-H7□/H7□W/H7NF

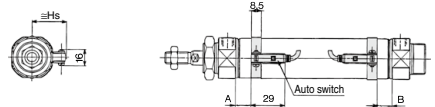

D-G5NT

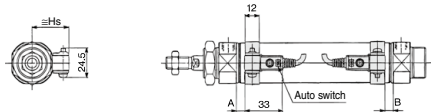

D-G39A/K39A

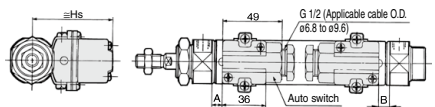

D-H7C

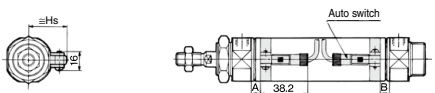

Auto Switch Proper Mounting Position (Detection at Stroke End) and Its Mounting Height

Auto Switch Proper Mounting Position

(mm)

Auto switch model Bore size (mm)	D-M9□(V) D-M9□W(V) D-M9□A(V)		D-A9□(V)		D-B5□ D-B64		D-C7□ D-C80 D-C73C D-C80C		D-B59W		D-A3□A D-G39A D-K39A D-A44A		D-H7□ D-H7C D-H7□W D-H7NF		D-G5NT	
	A	B	A	B	A	B	A	B	A	B	A	B	A	B	A	B
20	11	9.5	7	5.5	1	0	7	6	4	3	0.5	0	6	5	2.5	1.5
25	10	10	6	6	1	0	7	6	4	3	0.5	0	6	5	2.5	1.5
32	11.5	10.5	7.5	6.5	2	1	8	7	5	4	1.5	0.5	7	6	3.5	2.5
40	17.5	15.5	13.5	11.5	7	6	13	12	10	9	6.5	5.5	12	11	8.5	7.5

Note) Adjust the auto switch after confirming the operating conditions in the actual setting.

Auto Switch Mounting Height

(mm)

Auto switch model Bore size (mm)	D-M9□V D-M9□WV D-M9□AV D-A9□V	D-B5□ D-B64 D-B59W D-G5NT D-H7C	D-C7□ D-C80 D-H7□ D-H7□W D-H7NF	D-C73C D-C80C	D-A3□A D-G39A D-K39A	D-A44A
	Hs	Hs	Hs	Hs	Hs	Hs
20	23.5	25.5	22.5	25	60	69.5
25	26	28	25	27.5	62.5	72
32	29.5	31.5	28.5	31	66	75.5
40	33.5	35.5	32.5	35	70	79.5

- REA
- REB
- REC
- C□Y
- C□X**
- MQ
- RHC
- RZQ

- D-□
- X□

Series CM2X

Auto Switch Mounting 2

Minimum Auto Switch Mounting Stroke

Auto switch model	No. of auto switch mounted				
	1 pc.	2 pcs.		n pcs.	
		Different surfaces	Same surface	Different surfaces	Same surface
D-M9□	5	20	55	$20 + 35 \frac{(n-2)}{2}$ (n = 2, 4, 6...) ^{Note 3)}	$55 + 35 (n-2)$ (n = 2, 3, 4, 5...)
D-M9□W	10	20	55	$20 + 35 \frac{(n-2)}{2}$ (n = 2, 4, 6...) ^{Note 3)}	$55 + 35 (n-2)$ (n = 2, 3, 4, 5...)
D-M9□A	10	25	60	$25 + 35 \frac{(n-2)}{2}$ (n = 2, 4, 6...) ^{Note 3)}	$60 + 35 (n-2)$ (n = 2, 3, 4, 5...)
D-A9□	5	15	50	$15 + 35 \frac{(n-2)}{2}$ (n = 2, 4, 6...) ^{Note 3)}	$50 + 35 (n-2)$ (n = 2, 3, 4, 5...)
D-M9□V	5	20	35	$20 + 35 \frac{(n-2)}{2}$ (n = 2, 4, 6...) ^{Note 3)}	$35 + 35 (n-2)$ (n = 2, 3, 4, 5...)
D-A9□V	5	15	25	$15 + 35 \frac{(n-2)}{2}$ (n = 2, 4, 6...) ^{Note 3)}	$25 + 35 (n-2)$ (n = 2, 3, 4, 5...)
D-M9□WV D-M9□AV	10	20	35	$20 + 35 \frac{(n-2)}{2}$ (n = 2, 4, 6...) ^{Note 3)}	$35 + 35 (n-2)$ (n = 2, 3, 4, 5...)
D-C7□ D-C80	10	15	50	$15 + 45 \frac{(n-2)}{2}$ (n = 2, 4, 6...) ^{Note 3)}	$50 + 45 (n-2)$ (n = 2, 3, 4, 5...)
D-H7□ D-H7□W D-H7NF	10	15	60	$15 + 45 \frac{(n-2)}{2}$ (n = 2, 4, 6...) ^{Note 3)}	$60 + 45 (n-2)$ (n = 2, 3, 4, 5...)
D-C73C D-C80C D-H7C	10	15	65	$15 + 50 \frac{(n-2)}{2}$ (n = 2, 4, 6...) ^{Note 3)}	$65 + 50 (n-2)$ (n = 2, 3, 4, 5...)
D-B5□/B64 D-G5NT	10	15	75	$15 + 50 \frac{(n-2)}{2}$ (n = 2, 4, 6...) ^{Note 3)}	$75 + 55 (n-2)$ (n = 2, 3, 4, 5...)
D-B59W	15	20	75	$20 + 50 \frac{(n-2)}{2}$ (n = 2, 4, 6...) ^{Note 3)}	$75 + 55 (n-2)$ (n = 2, 3, 4, 5...)
D-A3□A/G39A D-K39A/A44A	10	35	100	$35 + 30 (n-2)$ (n = 2, 3, 4, 5...)	$100 + 100 (n-2)$ (n = 2, 3, 4, 5...)

Note 3) When "n" is an odd number, an even number that is one larger than this odd number is used for the calculation.

Note 1) Auto switch mounting

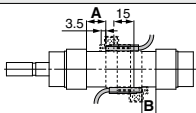
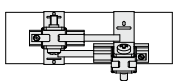
Auto switch model	With 2 auto switches	
	Different surfaces	Same surface
	 <p>Correct auto switch mounting position is 3.5 mm from the back face of the switch holder.</p>	 <p>The auto switch is mounted by slightly displacing it in a direction (cylinder tube circumferential exterior) so that the auto switch and lead wire do not interfere with each other.</p>
D-M9□ D-M9□W	Less than 20 stroke ^{Note 2)}	Less than 55 stroke ^{Note 2)}
D-M9□A	Less than 25 stroke ^{Note 2)}	Less than 60 stroke ^{Note 2)}
D-A9□	—	Less than 50 stroke ^{Note 2)}

Note 2) Minimum stroke for auto switch mounting in styles other than those in Note 1.

Operating Range

Auto switch model	(mm)			
	Bore size (mm)			
D-A9□(V)	20	25	32	40
D-M9□(V)	6	6	6	6
D-M9□W(V)	3.5	3	3.5	3
D-M9□A(V)	7	8	8	8
D-C7□/C80	7	8	8	8
D-C73C/C80C	8	8	9	9
D-B5□/B64	8	8	9	9
D-A3□A/A44A				

Auto switch model	(mm)			
	Bore size (mm)			
D-B59W	20	25	32	40
D-H7□/H7□W	12	12	13	13
D-G5NT/H7NF	4	4	4.5	5
D-H7C	7	8.5	9	10
D-G39A/K39A	8	9	9	9

* Since this is a guideline including hysteresis, not meant to be guaranteed. (Assuming approximately ±30% dispersion)
There may be the case it will vary substantially depending on an ambient environment.

Auto Switch Mounting Bracket Part No.

Auto switch model	Bore size (mm)			
	ø20	ø25	ø32	ø40
D-M9□(V) D-M9□W(V) D-A9□(V)	Note 1) BM5-020	Note 1) BM5-025	Note 1) BM5-032	Note 1) BM5-040
D-M9□A(V)	Note 2) BM5-020S	Note 2) BM5-025S	Note 2) BM5-032S	Note 2) BM5-040S
D-C7□/C80 D-C73C/C80C D-H7□ D-H7□W D-H7NF	BM2-020	BM2-025	BM2-032	BM2-040
D-B5□/B64 D-B59W D-G5NT D-G5NB	BA2-020	BA2-025	BA2-032	BA2-040
D-A3□A/A44A D-G39A/K39A	BM3-020	BM3-025	BM3-032	BM3-040

Note 1) Set part number which includes the auto switch mounting band (BM2-□□□A) and the holder kit (BJ5-1/Switch bracket: Transparent).

Since the switch bracket (made from nylon) is affected in an environment where alcohol, chloroform, methylamines, hydrochloric acid or sulfuric acid is splashed over, so it cannot be used. Please consult SMC regarding other chemicals.

Note 2) Set part number which includes the auto switch mounting band (BM2-□□□AS) and the holder kit (BJ4-1/Switch bracket: White).

Note 3) For the D-M9□A (V) type auto switch, do not install the switch bracket on the indicator light.

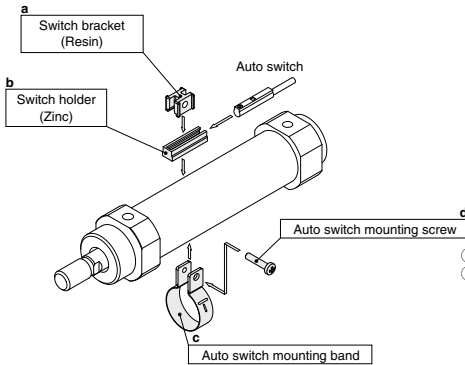

- ① BJ□-1: A set of a and b in the figure.
- ② BM2-□□□A(S): A set of c and d in the figure.
Band (c) is mounted so that the projected part is on the internal side (contact side with the tube).
BJ4-1 (Switch bracket: White)
BJ5-1 (Switch bracket: Transparent)

Other than the applicable auto switches listed in "How to Order", the following auto switches can be mounted. For detailed specifications, refer to pages 1893 to 2007.

Auto switch type	Model	Electrical entry (Direction)	Features
Reed	D-B53, C73, C76	Grommet (In-line)	—
	D-C80		Without indicator light
Solid state	D-H7A1, H7A2, H7B		—
	D-H7NW, H7PW, H7BW		Diagnostic indication (2-color indication)
	D-G5NT	With timer	

- * With pre-wired connector is available for solid state auto switches. For details, refer to pages 1960 to 1961.
- * Normally closed (NC = b contact), solid state auto switches (D-F9G, F9H type) are also available. For details, refer to page 1911.
- * Wide range detection type, solid state auto switches (D-G5NB type) are also available. Refer to page 1953 for details.

REA
REB
REC
C□Y
C□X
MQ
RHC
RZQ

D-□
-X□

Series 10-, 11-CQSX,CQ2X

Clean Series Low Speed Cylinder Series 10-, 11-

The type which is applicable for using inside the clean room graded Class 100 by making an actuator's rod section a double seal construction and discharging by relief port directly to the outside of clean room.

Since the external dimensions and applicable auto switches are the same as standard type, refer to the separate catalog of "Pneumatic Clean Series".

Series 10-, 11-CQSX

How to Order

Clean Series

10	Relief type
11	Vacuum type

10 - C(D)QSX B 20 - 30 D - M9BW

With auto switch (Built-in magnet)

Low speed cylinder

Mounting style

B	Through-hole/Both ends tapped common (Standard)
---	---

Bore size

12	12 mm
16	16 mm
20	20 mm
25	25 mm

Cylinder stroke (mm)

Bore size (mm)	Standard stroke (mm)
12, 16	5, 10, 15, 20, 25, 30
20	5, 10, 15, 20, 25, 30, 35, 40, 45, 50
25	5, 10, 15, 20, 25, 30, 35, 40, 45, 50

Number of auto switches

Nil	2 pcs.
S	1 pc.
n	"n" pcs.

Auto switch

Nil	Without auto switch (Built-in magnet)
-----	---------------------------------------

* For the applicable auto switch model, refer to page 1261.
* Auto switches are shipped together, (but not assembled).

Rod end thread

Nil	Standard (Rod end female thread)
M	Rod end male thread

Action

D	Double acting
---	---------------



Specifications

Bore size (mm)	10- (Relief type)			
	12	16	20	25
Fluid	Air			
Proof pressure	1.5 MPa			
Maximum operating pressure	1.0 MPa			
Minimum operating pressure	0.04 MPa 0.035 MPa			
Ambient and fluid temperature	Without auto switch: -10 to 70°C With auto switch: -10 to 60°C			
Piston speed	1 to 200 mm/s			
Piston rod size	ø6	ø8	ø10	ø12
Rod end thread	Female thread M3 x 0.5 Male thread M5 x 0.8	M4 x 0.7 M6 x 1.0	M5 x 0.8 M8 x 1.25	M6 x 1.0 M10 x 1.25
Stroke tolerance	+1.0 mm			
Port size	M5 x 0.8			
Vacuum port, Relief port	M5 x 0.8			

Bore size (mm)	11- (Vacuum type)			
	12	16	20	25
Fluid	Air			
Proof pressure	1.5 MPa			
Maximum operating pressure	1.0 MPa			
Minimum operating pressure	0.03 MPa 0.025 MPa			
Ambient and fluid temperature	Without auto switch: -10 to 70°C With auto switch: -10 to 60°C			
Piston speed	1 to 200 mm/s 0.5 to 200 mm/s			
Piston rod size	ø6	ø8	ø10	ø12
Rod end thread	Female thread M3 x 0.5 Male thread M5 x 0.8	M4 x 0.7 M6 x 1.0	M5 x 0.8 M8 x 1.25	M6 x 1.0 M10 x 1.25
Stroke tolerance	+1.0 mm			
Port size	M5 x 0.8			
Vacuum port, Relief port	M5 x 0.8			

Series 10-, 11-CQ2X

How to Order

Clean Series

10	Relief type
11	Vacuum type

10 - C(D)Q2XB 40 - 30 D - J79W

With auto switch (Built-in magnet)

Low speed cylinder

Bore size

32	32 mm
40	40 mm
50	50 mm
63	63 mm

Port thread type

Nil	Rc	ø32 to ø100
TN	NPT	
TF	G	

* Without auto switch, ø32, 5 strokes:
M thread

Cylinder stroke (mm)

Bore size (mm)	Standard stroke (mm)
32, 40	5, 10, 15, 20, 25, 30, 35, 40, 45, 50, 75, 100
50, 63	10, 15, 20, 25, 30, 35, 40, 45, 50, 75, 100

Number of auto switches

Nil	2 pcs.
S	1 pc.
n	"n" pcs.

Action

D	Double acting
---	---------------

Auto switch

Nil	Without auto switch (Built-in magnet)
-----	---------------------------------------

* For the applicable auto switch model, refer to page 1268.
* Auto switches are shipped together, (but not assembled).

Rod end thread

Nil	Standard (Rod end female thread)
M	Rod end male thread



Manufacturing of Intermediate stroke
Intermediate strokes by the 1 mm interval are available by using spacers with standard stroke cylinders. But, as for ø40 with damper, please consult SMC separately.
Example) 18 mm width spacer is installed in the standard cylinder 10-CQ2XB40-75D to make 10-CQ2XB40-57D.

Specifications

Bore size (mm)	10- (Relief type)				11- (Vacuum type)			
	32	40	50	63	32	40	50	63
Fluid	Air							
Proof pressure	1.5 MPa							
Maximum operating pressure	1.0 MPa							
Minimum operating pressure	0.035 MPa 0.03 MPa 0.025 MPa 0.02 MPa							
Ambient and fluid temperature	Without auto switch: -10 to 70°C With auto switch: -10 to 60°C							
Piston speed	1 to 200 mm/s 0.5 to 200 mm/s							
Piston rod size	ø16	ø20	ø16	ø20	ø16	ø20	ø16	ø20
Rod end thread	Female thread M8 x 1.25 Male thread M14 x 1.5	M10 x 1.5 M18 x 1.5	M8 x 1.25 M14 x 1.5	M10 x 1.5 M18 x 1.5	Female thread M8 x 1.25 Male thread M14 x 1.5	M10 x 1.5 M18 x 1.5	M8 x 1.25 M14 x 1.5	M10 x 1.5 M18 x 1.5
Stroke tolerance	+1.0 mm							
Port size	M5 x 0.8, 1/8 ^(NPT) 1/4 M5 x 0.8, 1/8 ^(NPT) 1/4							
Vacuum port, Relief port	M5 x 0.8							

Note) Only 5 stroke comes with M5 x 0.8 in the case of no auto switch on ø32.

Clean Series Low Speed Cylinder *Series 10-, 11-CM2X*

10-,11- CM2X Series

How to Order

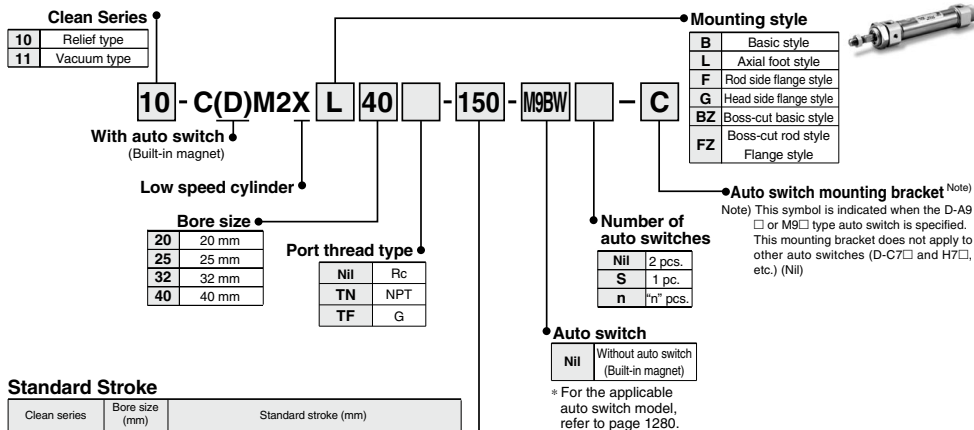

Standard Stroke

Clean series	Bore size (mm)	Standard stroke (mm)
10- (Relief type)	20	25, 50, 75, 100, 125, 150, 175, 200, 250, 300
	25	
	32	
	40	
11- (Vacuum type)	20	
	25	
	32	
	40	

* Manufacture of intermediate strokes at 1 mm intervals is possible. (Spacers are not used.)

Specifications

Bore size (mm)	10- (Relief type)				11- (Vacuum type)			
	20	25	32	40	20	25	32	40
Fluid	Air							
Proof pressure	1.5 MPa							
Maximum operating pressure	1.0 MPa							
Minimum operating pressure	0.035 MPa				0.025 MPa			
Ambient and fluid temperature	Without auto switch: -10 to 70°C With auto switch: -10 to 60°C							
Cushion	Rubber bumper							
Piston speed	1 to 200 mm/s				0.5 to 200 mm/s			
Piston rod size	ø8	ø10	ø12	ø14	ø8	ø10	ø12	ø14
Rod end thread	M8 x 1.25	M10 x 1.25		M14 x 1.5	M8 x 1.25	M10 x 1.25		M14 x 1.5
Stroke tolerance	+1.4 0 mm							
Port size	1/8			1/4	1/8			1/4
Vacuum port, Relief port	M5 x 0.8							

⚠ Precautions

- Be sure to read before handling.
 Refer to front matter 39 for Safety Instructions and pages 3 to 12 for Actuator and Auto Switch Precautions.
 Refer to the Clean Series catalog separately for the precautions in clean environments.

Operating Precautions

⚠ Warning

- Do not rotate the cover.
 - When installing a cylinder or screwing a pipe fitting into the port, the coupling portion of the cover could break if the cover rotated.

⚠ Caution

- Be careful of the snap ring to pop out.
 - When replacing the rod seal, take care that the snap ring does not spring out while you are removing it.

Maintenance

⚠ Caution

- Grease pack
 - When maintenance requires only grease, use the following part number to order.
 - Grease pack part no.: GR-X-005 (5 g)

REA

REB

REC

C□Y

C□X

MQ

RHC

RZQ

D-□

-X□

Related Products: Made to Order Specifications: -XB13: Low Speed Cylinder

5 to 50 mm/s (CY1/CY3: 7 to 50 mm/s)



Low Speed Cylinder Symbol -XB13

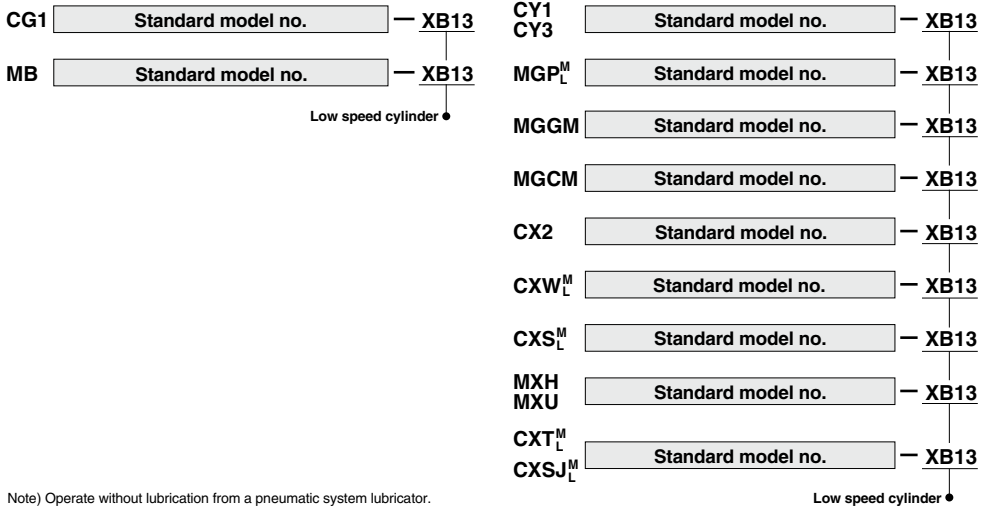

(Note) Operate without lubrication from a pneumatic system lubricator.

Specifications

Applicable cylinder	Air cylinder Standard		Magnetically coupled rodless cylinder	Compact guide cylinder	Guide cylinder		Slide unit		Dual rod cylinder		Compact slide		Platform cylinder
	CG1	MB			Slide bearing	CX2	CXW ^M _L	CXSJ ^M _L	CXS ^M _L	MXH	MXU	CXT ^M _L	
Series	CG1	MB	CY¹₃	MGP^M_L	MGGM	MGCM	CX2	CXW^M_L	CXSJ^M_L	CXS^M_L	MXH	MXU	CXT^M_L
Action	Double acting, Single rod			Double acting									
Bore size (mm)	20, 25, 32 40, 50, 63 80, 100	32, 40 50, 63 80, 100	CY3B: 6, 10, 15, 20, 25, 32 40, 50, 63 CY1S, CY1L: 6 to 40	12, 16, 20 25, 32, 40 50, 63, 80 100	20, 25, 32 40, 50, 63 80, 100	20, 25 32, 40 50	10, 15 25	10, 16 20, 25 32	6, 10 15, 20 25, 32	6, 10 15, 20 25, 32	6, 10 16, 20	6, 10 16	12, 16 20, 25 32, 40
Piston speed	5 to 50 mm/s		7 to 50 mm/s	5 to 50 mm/s	5 to 50 mm/s								
Cushion	Rubber bumper	Air cushion on both ends	Rubber bumper	Rubber bumper (Basic cylinder)	Shock absorber (CX2: Option)	Rubber bumper							
Auto switch	Mountable												
Mounting	Basic Foot Flange Trunnion Clevis	Basic Foot Flange Clevis Trunnion	Basic Slider	Basic	Basic Front mounting Flange	Basic							
Dimensions	Dimensions and specifications are the same as standard products of double acting.												
Additional specifications													

* No shock absorber is available for the Series MGGM.

Related Products:

Speed Controller for Low Speed Operation

The effective area of controlled flow is approximately 1/10 of the standard type.

These controllers are suitable for controlling the speed of microspeed cylinders.

The dual type speed controller is especially suitable for cylinders with a small bore size.

Elbow/Universal Type



Air Flow/Effective Area

Model		AS12□1FM-M5 AS13□1FM-M5	AS22□1FM-□01 AS23□1FM-□01		AS22□1FM-□02 AS23□1FM-□02		
Tubing O.D.	Metric size	ø3.2, ø4, ø6	ø3.2, ø4	ø6, ø8	ø4	ø6	ø8, ø10
	Inch size	ø1/8", ø5/32", ø3/16" ø1/4"	ø1/8", ø5/32"	ø3/16", ø1/4" ø5/16"	ø5/32"	ø3/16"	ø1/4", ø5/16" ø3/8"
Controlled flow	Air flow (L/min (ANR))	7	12		38		
	Effective area (mm ²)	0.1	0.2		0.6		
Free flow	Flow rate (L/min (ANR))	100	180	230	260	390	460
	Effective area (mm ²)	1.5	2.7	3.5	4	6	7

Note) Supply pressure: 0.5 MPa, Temperature: 20°C

In-line Type



Air Flow/Effective Area

Model		AS1001FM	AS2001FM		AS2051FM	
Tubing O.D.	Metric size	ø3.2, ø4, ø6	ø4	ø6	ø6	ø8
	Inch size	ø1/8", ø5/32", ø3/16" ø1/4"	ø5/32"	ø3/16", ø1/4"	ø3/16"	ø1/4", ø5/16"
Controlled flow	Air flow (L/min (ANR))	7	12		38	
	Effective area (mm ²)	0.1	0.2		0.6	
Free flow	Flow rate (L/min (ANR))	100	130	230	290	460
	Effective area (mm ²)	1.5	2	3.5	4.5	7

Note) Supply pressure: 0.5 MPa, Temperature: 20°C

Elbow Type (Metal body)



Air Flow/Effective Area

Model		AS12□0M		AS22□0M-□01		AS22□0M-□02	
Port size	Cylinder side	M5 x 0.8	10-32 UNF	R 1/8	NPT 1/8		R 1/4
	Tube side			Rc 1/8			Rc 1/4
Controlled flow	Air flow (L/min (ANR))	7		12		38	
	Effective area (mm ²)	0.1		0.2		0.6	
Free flow	Flow rate (L/min (ANR))	105		280		420	
	Effective area (mm ²)	1.6		4.3		6.5	

Note) Supply pressure: 0.5 MPa, Temperature: 20°C

Dual Type



Air Flow/Effective Area

Model		ASD230FM-M5	ASD330FM-□01	ASD430FM-□02	
Tubing O.D.	Metric size	ø4, ø6	ø6, ø8	ø6	ø8, ø10
	Inch size	ø1/8", ø5/32" ø3/16", ø1/4"	ø3/16", ø1/4"	—	ø1/4", ø5/16" ø3/8"
Controlled flow (Free flow)	Air flow (L/min (ANR))	7	12	38	
	Effective area (mm ²)	0.1	0.2	0.6	

Note) Supply pressure: 0.5 MPa, Temperature: 20°C

REA

REB

REC

COY

COX

MQ

RHC

RZQ

D-□

-X□



Low Speed Cylinder Specific Product Precautions 1

Be sure to read before handling.

Refer to front matter 39 for Safety Instructions and pages 3 to 12 for Actuator and Auto Switch Precautions.

Recommended Pneumatic Circuit

Warning

Horizontal Operation

I

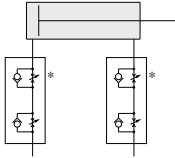

Dual speed controller

Speed is controlled by meter-out circuit. Using concurrently the meter-in circuit can alleviate the stick-slip. More stable low speed operation can be achieved than meter-in circuit alone.

II

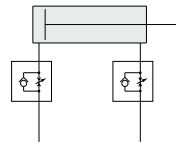

Meter-in speed controller

Meter-in speed controllers can reduce lurching while controlling the speed. The two adjustment needles facilitate adjustment.

Vertical Operation

I

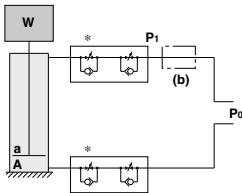

- (1) Speed is controlled by meter-out circuit. Using concurrently the meter-in circuit can alleviate the stick-slip.*
- (2) Depending on the size of the load, installing a regulator with check valve at position (b) can deduce lurching during descent and operation delay during ascent.
As a guide,
when $W + P_0a > P_0A$,
adjust P_1 to make $W + P_1a = P_0A$.

II

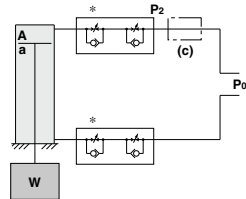

- (1) Speed is controlled by meter-out circuit. Using concurrently the meter-in circuit can alleviate the stick-slip.*
- (2) Installing a regulator with check valve at position (c) can reduce lurching during descent and operation delay during ascent.
As a guide,
adjust P_2 to make $W + P_2A = P_0a$.

W: Load (N) P₀: Operating pressure (MPa) P₁, P₂: Reduced pressure (MPa) a: Rod side piston area (mm²) A: Head side piston area (mm²)

Warning

Since C□J2X, C□UX10 are subject to internal leakage due to their construction, the speed may not be fully controlled with the meter-out controller (*) during low speed operation.

Selection

Caution

- 1. Operate within the standard strokes.**
Operating with the stroke exceeding the standard stroke may cause malfunction.
- 2. Provide a construction that does not apply a lateral load to the cylinder.**
Applying a lateral load to the cylinder may cause malfunction.
- 3. Do not use the product at a high frequency.**
Use it at 30 cpm or less as a guideline.
- 4. Do not wipe out the grease in the sliding part of the air cylinder.**
Doing so forcefully may cause malfunction.

Pneumatic Circuit

Caution

- 1. The piping length between the speed controller and the cylinder port must be kept as short as possible.**
If the speed controller and the cylinder port are far apart, speed adjustment may be unstable.
- 2. Use a low speed controller to easily adjust for low speed operation or a dual speed controller (Series ASD) to prevent cylinders from popping out.**
(When the low speed controller is used, the maximum speed may be limited.)



Low Speed Cylinder Specific Product Precautions 2

Be sure to read before handling.

Refer to front matter 39 for Safety Instructions and pages 3 to 12 for Actuator and Auto Switch Precautions.

Design

Caution

1. **Design the system to prevent vibration from being applied to the cylinder.**

A malfunction may occur due to the vibration.

2. **Avoid using a guide with obvious variations in operating resistance.**

Operation may become unstable when using a guide that manifests variations in operating resistance, or when the external load changes.

3. **Avoid a system structure in which the mounting orientation changes.**

Operation may become unstable if the mounting orientation changes.

4. **Avoid operation where the temperature fluctuates greatly. Also, when using at low temperatures, make sure that frost does not form inside the cylinder and on the piston rod.**

Operation may become unstable.

5. **Adjust the speed in accordance with the operating environment.**

When the operating environment changes, the speed adjustment will be off unless it is reset to reflect operation in the new environment.

Cushion

Caution

1. **Readjust cushion using the cushion needle.**

Cushions are adjusted at the time of shipment. However, the cushion needle on the cover should be readjusted when the product is put into service, based on factors such as the size of the load and the operating speed. When the cushion needle is turned clockwise, the restriction becomes smaller and the cushion's effectiveness is increased. Tighten the lock nut securely after adjustment is performed. A malfunction may occur when the restriction becomes smaller.

2. **Do not operate with the cushion needle fully closed.**

This will cause damage to the seals.

Lubrication

Caution

1. **Operate without lubrication from a pneumatic system lubricator.**

Malfunction may occur when lubricated in this fashion.

2. **Only use the grease recommended by SMC.**

The microspeed cylinder and the microspeed cylinder with clean room specifications use different types of grease. The use of grease other than the specified type can cause malfunctions and particulate generation.

Air Supply

Warning

1. **Use clean air.**

Do not use compressed air that is tainted with chemicals, synthetic oils containing organic solvents, salt or corrosive gases, as it can cause damage or malfunctions.

2. **Take measures to prevent pressure fluctuation.**

Malfunctions may occur with the fluctuation of pressure.

Operating Environment

Warning

1. **Do not use in environments where there is a danger of corrosion.**

2. **Do not use in dusty environments or where exposure to water and oil spray or splash are expected.**

Lubrication of Actuators

Caution

1. **The microspeed cylinder and the microspeed cylinder with clean room specifications use different types of grease. For the microspeed cylinder with clean room specifications, use GR-X-005 (5g pack).**

REA

REB

REC

QY

X

MQ

RHC

RZQ

D-

-X